

**STONE**

Design HANGAR DESIGN GROUP SRL

**STONE SP**

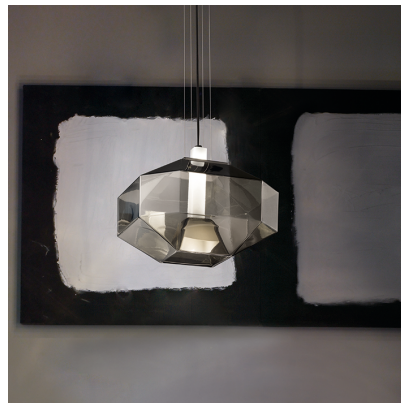

## STONE SP

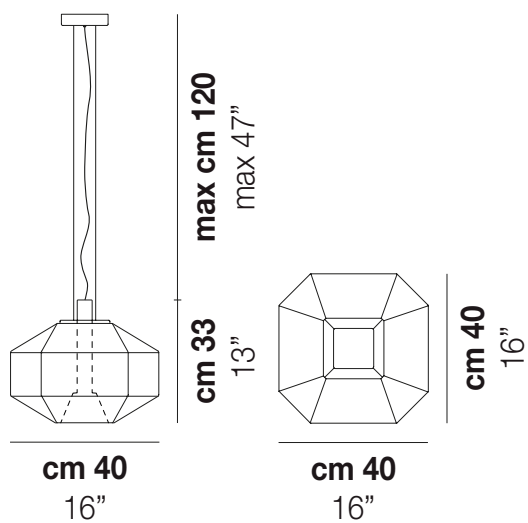

### DATOS TÉCNICOS:



### CERTIFICATIONS:



### FUENTES DE LUZ

E14	1x48w	220-240V 50/60 Hz	E14
LED B 8.3W 3.000K	1x2w	220-240V 50/60 Hz	LED
+	1x8w	220-240V 50/60 Hz	LED

VOLUME	Mc 0,16
PESO BRUTO	Kg 13
PESO NETO	Kg 9

download



### ACABADO DEL DIFUSOR



CR/BC

FU/BC

### ACABADO PARTES METÁLICAS



NN