

cattelan
italia

6/7

COLLECTION 2016 / 17



TAVOLI
TABLES



GORDON page 68



GORDON DEEP WOOD page 78



GORDON KERAMIK page 72



HYSTRIX page 100



IPANEMA KERAMIK page 110



KLIRR page 82



PREMIER KERAMIK page 28



ROLL KERAMIK page 86



ROLL ROUND page 92



ROLL WOOD page 96



ROLL WOOD ROUND page 94



SKORPIO page 24



SKORPIO KERAMIK page 14



SPYDER page 58



SPYDER KERAMIK page 64



STRATOS KERAMIK page 52



STRATOS WOOD page 46



YODA KERAMIK page 104



YODA WOOD page 109

TAVOLI ALLUNGABILI
EXTENDIBLE
DINING TABLES



PREMIER DRIVE page 40



PREMIER KERAMIK DRIVE page 34



PREMIER WOOD DRIVE page 42

BISTROT
BISTROT



NIDO KERAMIK BISTROT page 112

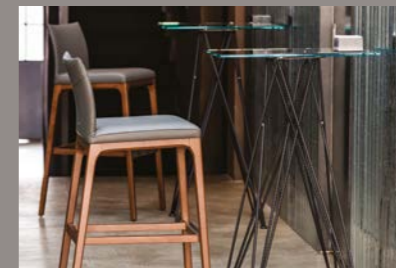

RALPH BISTROT page 118



RALPH KERAMIK BISTROT page 116

CONSOLLE
CONSOLES



STRATOS CONSOLLE page 120



TREVI page 122

SCRIVANIA
DESK



AIRPORT page 224



CLARION page 128



NASDAQ page 124

SEDIE
CHAIRS



ARCADIA page 132



ARCADIA COUTURE page 138



BETTY page 170



DUMBO page 152



FLAMINIA page 174



GINGER page 166



INDY page 156



JANET page 176



NORMA page 142



NORMA COUTURE page 146



PIUMA EDITION page 172



RITA page 162

SGABELLI
STOOLS



ARCADIA SGABELLO page 180



ARCADIA COUTURE SGABELLO page 182



FLAMINIO page 186



ISABEL SGABELLO page 178



TOTO X page 184

MADIE
SIDEBOARDS



ABSOLUT page 190



EUROPA KERAMIK page 216



EXPLORER page 212



KAYAK page 188



METROPOL page 196



PARAMOUNT page 208



ROYALTON page 200



STANDARD page 220



TIFFANY page 204

PORTA TV
TV STANDS



PIXEL page 338

LIBRERIE
BOOKCASES



AIRPORT

page 224



ARSENAL

page 236



HUDSON

page 230



JOKER

page 240



TOKYO

page 234

TAVOLINI
COFFEE TABLES



ATARI

page 262



BILLY KERAMIK

page 258



BIPLANE

page 246



KITANO

page 266



KITANO

page 266



NIDO

page 254



NIDO

page 254



SPIRAL

page 242



STING

page 270



VINYL

page 250

SPECCHI
MIRRORS



CAMELOT

page 296



EMERALD WOOD

page 284



GLENN

page 274



HAWAII

page 280



JANEIRO

page 290



SAMIR

page 294



FOREVER \odot

page 300



MOMENT / R \odot

page 298



MOMENT / S \odot

page 299

SPECCHI MAGNUM
MAGNUM MIRRORS



EMERALD MAGNUM

page 286



GLENN MAGNUM

page 278



JANEIRO MAGNUM

page 292

LAMPADE A
SOSPENSIONE
PENDANT LAMPS



ASIA page 316



BYBLOS page 320



CELLINI page 302



CLOUD page 306



HAVANA page 324



POSEIDON page 310



RAVEL page 318



SABLIER page 312



STILO page 326



ZOOM page 322

LAMPADE DA TERRA
WALL LAMPS



BYBLOS-P page 320



LAMPO page 328



STEALTH page 332



THOR page 336



THRILLER page 334

LETTI
BEDS



AMADEUS page 358



EDWARD page 348



LUDOVIC page 354



NELSON page 344

TAPPETI
RUGS



MUMBAI page 341



RADJA page 340

COMODINI
NIGHTSTANDS



CIRO page 362



DANTE page 366

COMÒ
CHESTS OF DRAWERS



CIRO/8 page 362

CARRELLI
TROLLEYS



BRANDY page 342



SKORPIO KERAMIK table 320x138 with graphite base, glossy Golden Calacatta ceramic top - NORMA H chairs in soft leather 953 Ardesia
 POSEIDON lamps 18 in titanium frame - CHENNAI rugs - PARAMOUNT sideboard in fumé finish

SKORPIO KERAMIK

Design

A. Lucatello & P. Cattelan

Tavolo con base in acciaio verniciato trasparente, goffrato titanio, bianco, nero o graphite. Piano in ceramica Marmi nei colori Calacatta, Alabastro, Ardesia, Golden Calacatta opaco, Golden Calacatta lucido, Portoro opaco, Portoro lucido o ceramica Brown Zinc.

Table with transparent varnished metal base, titanium, white, black or graphite embossed lacquered steel. Top in ceramic Marmi in Calacatta, Alabastro, Ardesia, matt Golden Calacatta, glossy Golden Calacatta, matt Portoro, glossy Portoro or Brown Zinc ceramic top.

Table avec base en acier laqué transparent, gaufré titane, blanc, noir ou graphite. Plateau en céramique Marmi dans les couleurs Calacatta, Alabastro, Ardesia, Golden Calacatta opaque, Golden Calacatta brillante, Portoro opaque, Portoro brillant ou Brown Zinc.

Mesa con base en acero barnizado transparente, gofrado titanio, blanco, negro o graphite. Sobre en cerámica Marmi colores Calacatta, Alabastro, Ardesia, Golden Calacatta mate, Golden Calacatta brillo, Portoro mate, Portoro brillo o cerámica Brown Zinc. El acabado OPO de la base identifica una barniz transparente de la materia prima de hierro.

Esstisch mit Basis aus Metall lackiert transparent oder Titan, weiß, schwarz oder graphite gaufriert. Platte in Keramik Marmi in den Farben Calacatta, Alabastro, Ardesia, matt Golden Calacatta, glänzend Golden Calacatta, matt Portoro, glänzend Portoro oder Keramik Brown Zinc.

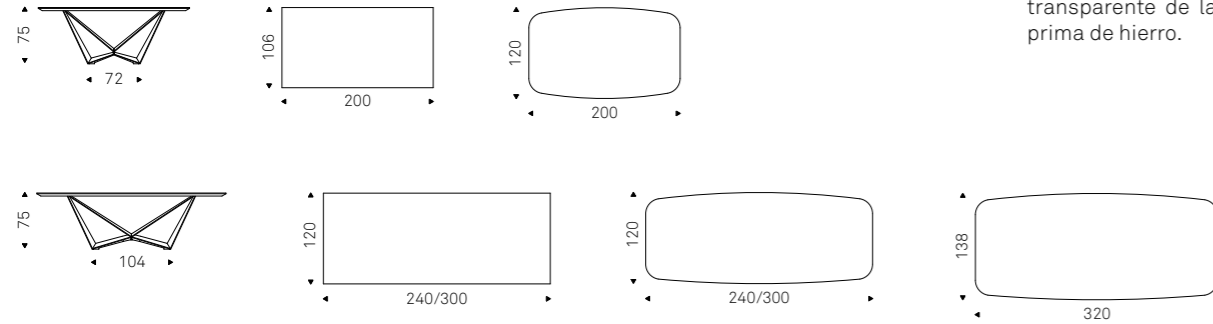



SKORPIO KERAMIK table with black base, glossy Portoto ceramic top - NORMA H COUTURE chairs in soft leather 942 Fango - CELLINI lamp - AIRPORT bookcase



SKORPIO KERAMIK table with black base, matt Golden Calacatta ceramic top - NORMA COUTURE chairs in soft leather 953 Ardesia
 CLOUD lamps 6 in smoked grey glass - NIDO coffee table - GLENN mirror bronze





SKORPIO KERAMIK table with OPD base, Ardesia ceramic top - ARCADIA chairs in soft leather 974 Capri and wengé frame - VENEZIA3 lamps
FUTURA sideboard graphite - CLOUD abat-jour in Iride glass

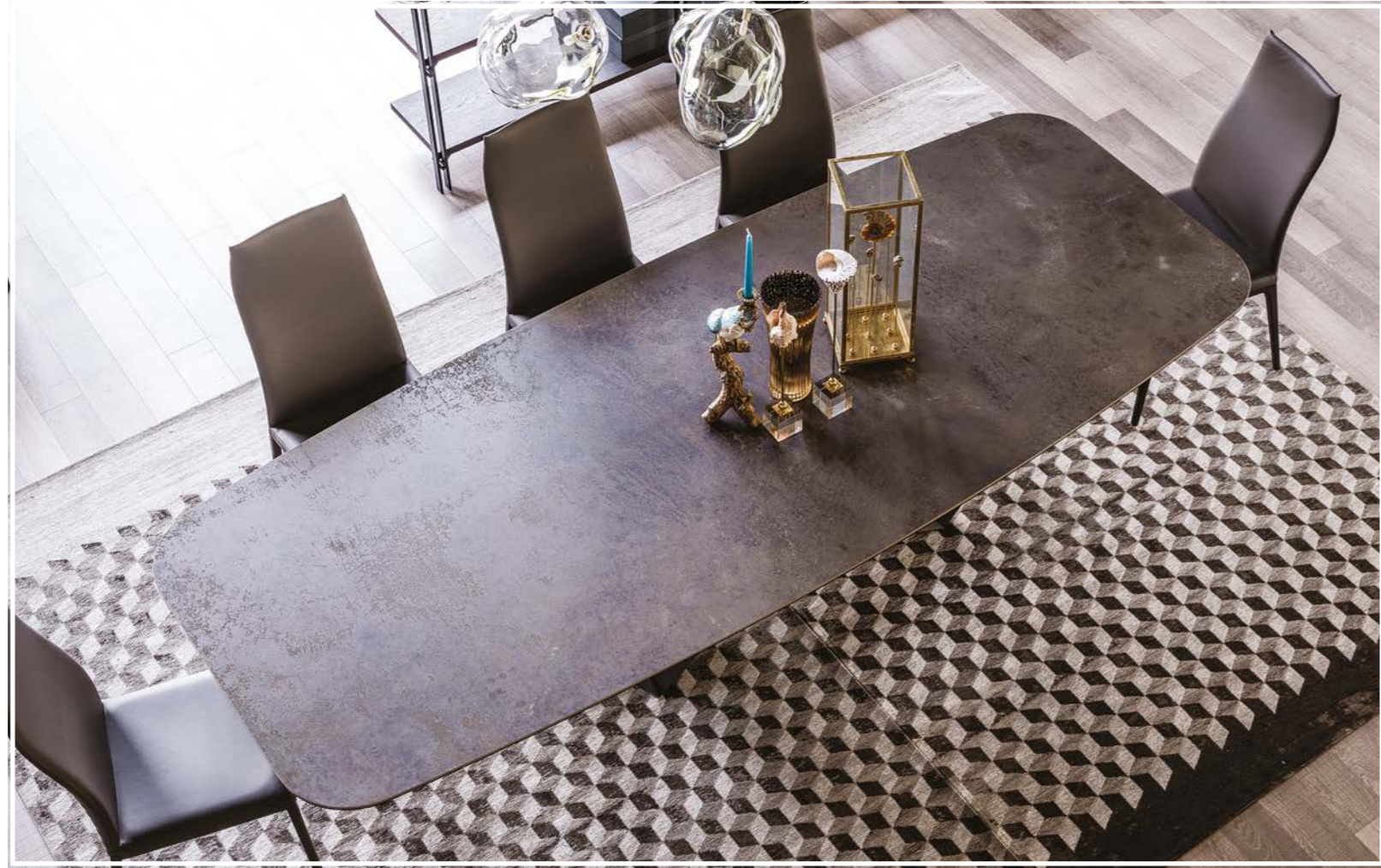

SKORPIO KERAMIK table with OP0 base, Zinc Brown ceramic top - ARCADIA H chairs in soft leather 953 Ardesia, wenghé base - CLOUD lamps - RUBIK rugs



SKORPIO KERAMIK table with OP0 base, Alabastro ceramic top - MAGDA chairs in soft leather 952 Smoke, Canaletto walnut frame - CRISTAL lamps S3 ZEPPELIN abat-jour - EUROPA sideboard graphite - TAXIDO mirror in soft leather 943 Moka

SKORPIO**Design Andrea Lucatello**

Tavolo con base in acciaio verniciato trasparente, gofrato titanio, bianco, nero o graphite. Piano in cristallo 15mm trasparente, trasparente extrachiaro o trasparente extrachiaro con bordi bisellati inversi. I piani 182x90 e 200x106 hanno spessore 12mm. Piano in appoggio.

Table with transparent varnished metal base, gofrato titanium, white, black or graphite embossed lacquered steel. Top in 15mm clear, extra clear or extra clear glass with reversed bevelled edges. Glass top 12mm on 182x90 and 200x106 versions. The top is laid on the base.

Table avec base en acier laqué transparent, gaufré titane, blanc, noir ou graphite. Plateau en verre clair 15 mm, extra-clair ou extra-clair avec bords biseautés inversés. Les plateaux 182x90 et 200x106 sont de 12mm. Plateau d'appui.

Mesa con base en acero barnizado transparente, gofrado titanio, blanco, negro o graphite. Sobre en cristal 15mm transparente, transparente extraclaro o transparente extraclaro con bordes biselados inversos. Los sobres 182x90cm y 200x106cm son de 12mm. Sobre en apoyo.

Esstisch mit Basis aus Metall lackiert transparent oder Titan, weiß, schwarz oder graphite gaufriert. Platte in 15mm Glas transparent, extra hell transparent, oder extra hell mit Kanten umgekehrt facettiert. Platten in 182x90 und 200x106 haben 12 mm Dicke. Platte auf die Basis gelegt.

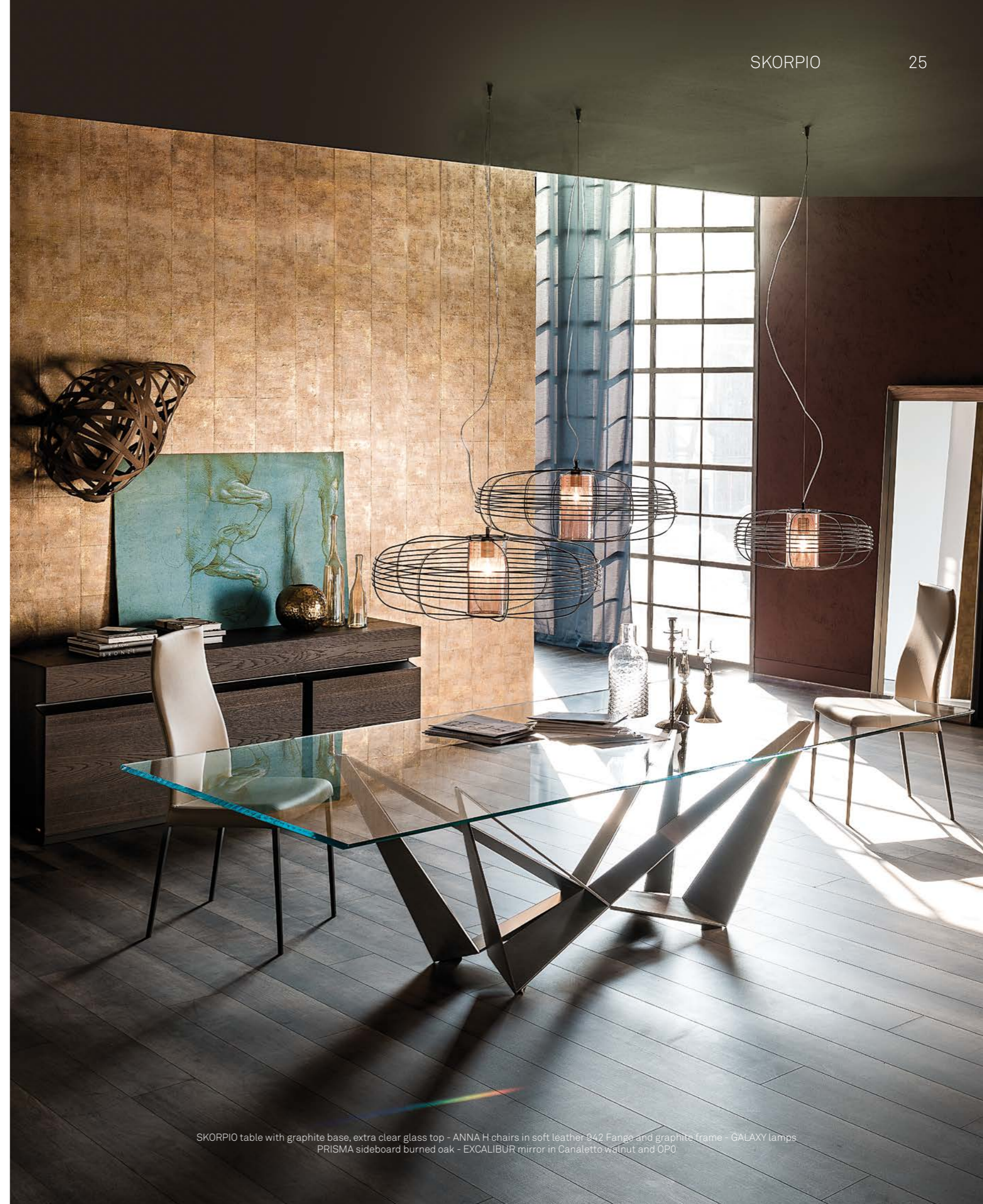
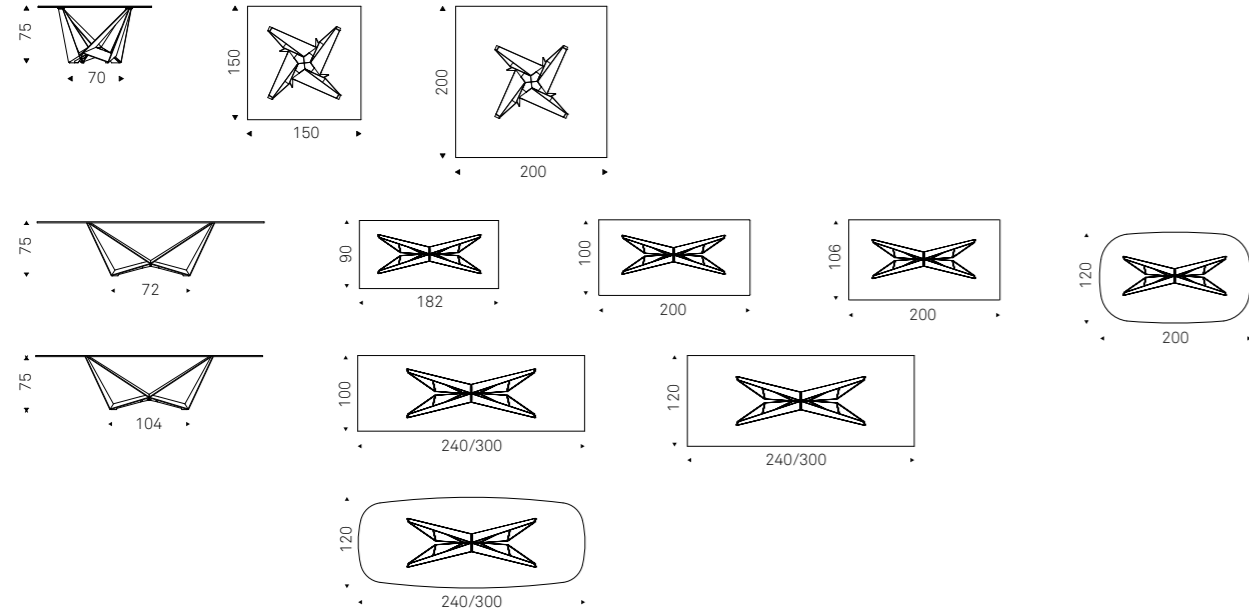



SKORPIO table with titanium base, extra clear glass top - ARCADIA H COUTURE chairs with seat in soft leather 947 Oyster and wenghé frame
 ASIA lamps (grey-bronze) - ROYALTON sideboard white - GLENN mirror in fumé glass

PREMIER KERAMIK**Design Andrea Lucatello**

Tavolo con base in acciaio verniciato gofrato titanio, graphite, nero. Piano in ceramica Marmi nei colori Calacatta, Alabastro, Ardesia, Golden Calacatta opaco, Golden Calacatta lucido, Portoro opaco, Portoro lucido o ceramica Brown Zinc.

Table with base in titanium, black or graphite embossed lacquered steel. Marmi Calacatta, Alabastro, Ardesia, matt Golden Calacatta, glossy Golden Calacatta, matt Portoro, glossy Portoro or Brown Zinc ceramic top.

Table avec base en acier gaufré titane, noir, graphite. Plateau en céramique dans les couleurs Marmi Calacatta, Alabastro, Ardesia, Golden Calacatta opaque, Golden Calacatta brillant, Portoro opaque, Portoro brillant ou Brown Zinc.

Mesa con base en acero barnizado gofrado titanio, negro o graphite. Sobre en cerámica Marmi colores Calacatta, Alabastro, Ardesia, Golden Calacatta mate, Golden Calacatta brillo, Portoro mate, Portoro brillo o cerámica Brown Zinc.

Esstisch mit Basis in Edelstahl lackiert titan, schwarz oder graphit gaufriert. Platte in Keramik Marmi in den Farben Calacatta, Alabastro, Ardesia, matt Golden Calacatta, glänzend Golden Calacatta, matt Portoro, glänzend Portoro oder Keramik Brown Zinc.

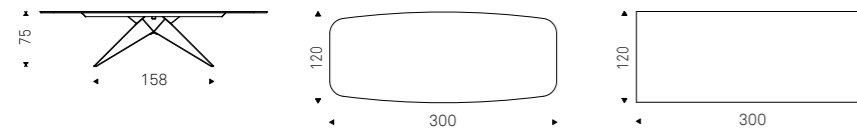
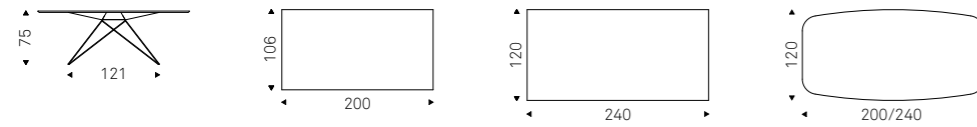
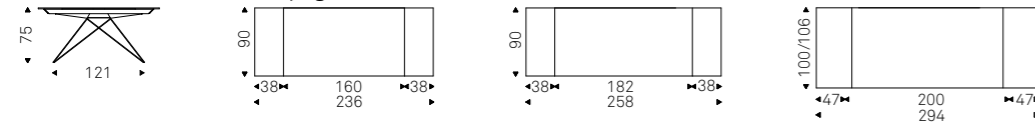
**PREMIER KERAMIK DRIVE page 34**

Graphite base, Zinc Brown ceramic top



PREMIER KERAMIK table with titanium base, Alabastro ceramic top - NORMA H COUTURE chairs in soft leather 953 Ardesia - SABLIER lamp in mixed glass (iride-fumé) - RADJA rugs



PREMIER KERAMIK table with titanium base, Alabastro ceramic top - NORMA H COUTURE chairs in soft leather 953 Ardesia
 SABLIER lamp in mixed glass (iride-fumé) - RADJA rugs - PARAMOUNT sideboard moka, doors in bronze mirrored glass



graphite base, matt Golden Calacatta ceramic top



graphite base, Calacatta ceramic top



graphite base, Ardesia ceramic top

PREMIER KERAMIK DRIVE

Design

A. Lucatello & G. Cattelan

Tavolo allungabile con base in acciaio verniciato gofrato titanio, graphite, nero. Piano e prolunghe in ceramica Marmi nei colori Calacatta, Alabastro, Ardesia, Golden Calacatta opaco, Golden Calacatta lucido, Portoro opaco, Portoro lucido o ceramica Brown Zinc.

Extendible table with base in titanium, graphite or black embossed lacquered steel. Laminam Fokos ceramic top and extensions in salt or lead colours or Marmi ceramic in Calacatta, Alabastro, Ardesia, matt Golden Calacatta, glossy Golden Calacatta, matt Portoro, glossy Portoro or Brown Zinc ceramic top.

Table à rallonges avec base en acier gaufré titane, graphite ou noir. Plateau et rallonges en céramique Laminam Fokos dans les couleurs sel ou plomb ou céramique Marmi dans les couleurs Calacatta, Alabastro, Ardesia, Golden Calacatta opaque, Golden Calacatta brillant, Portoro opaque, Portoro brillant ou Brown Zinc.

Mesa extensible con base en acero barnizado gofrado titanio, graphite o negro. Sobre y extensiones en cerámica Laminam Fokos colores sal o plomo o cerámica Marmi colores Calacatta, Alabastro, Ardesia, Golden Calacatta mate, Golden Calacatta brillo, Portoro mate, Portoro brillo o cerámica Brown Zinc.

Ausziehbarer Esstisch mit Basis in Edelstahl lackiert titan, graphit, schwarz gaufriert. Platte und Verlängerungen in Keramik Laminam Fokos in den Farben Salz oder Blei oder Keramik Marmi in den Farben Calacatta, Alabastro, Ardesia, matt Golden Calacatta, glänzend Golden Calacatta, matt Portoro, glänzend Portoro oder Keramik Brown Zinc.

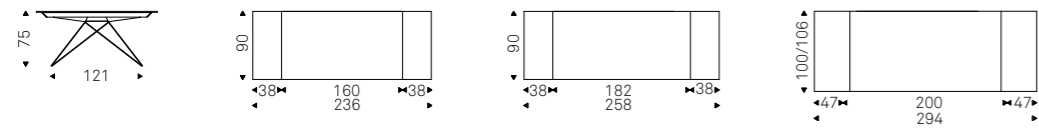

PREMIER KERAMIK page 28

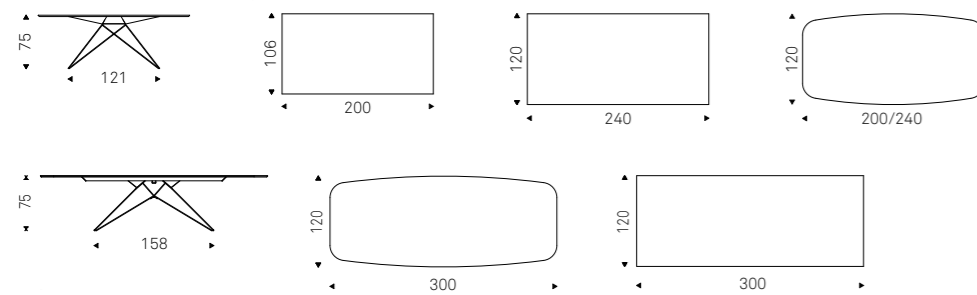

PREMIER KERAMIK DRIVE table with graphite base and glossy Golden Calacatta ceramic top - INDY chairs 101 with graphite base and seat in P02 Lino APOLLO lamps - ABSOLUT sideboard with covered doors in soft leather 971 Bianco



titanium base, glossy Golden Calacatta ceramic top



PREMIER KERAMIK DRIVE table with titanium base, glossy Golden Calacatta ceramic top - ARCADIA COUTURE chairs in soft leather 948 Lino, wenghe frame
 POSEIDON lamps 18 in matt black frame - KAYAK sideboard titanium - REGAL mirror fume



PREMIER KERAMIK DRIVE table with glossy Golden Calacatta ceramic top - INDY chairs 101 with graphite base and seat in P02 Lino
ABSOLUT sideboard with covered doors in soft leather 971 Bianco



titanium base, Ardesia ceramic top

PREMIER DRIVE**Design A. Lucatello & G. Cattelan**

Tavolo allungabile con base in acciaio verniciato gofrato titanio, graphite, nero. Piano e prolunghe in cristallo 12mm extrachiaro verniciato bianco, graphite, extrachiaro acidato bianco o graphite.

Extendible table with base in titanium, graphite, black embossed lacquered steel. Top and extensions in 12mm in white or graphite painted extra clear glass or white or graphite painted frosted extra clear glass.

Table à rallonges avec base en acier gaufré titane, graphite ou noir. Plateau et rallonges en verre extra-clair laqué blanc ou graphite ou extra-clair dépoli laqué blanc ou graphite 12mm.

Mesa extensible con base en acero barnizado gofrado titanio, graphite o negro. Sobre y extensiones en cristal 12mm extraclaro barnizado blanco o graphite o extraclaro translúcido barnizado blanco o graphite.

Ausziehbarer Esstisch mit Basis in Edelstahl lackiert titan, graphit, schwarz gaufriert. Platte und Verlängerungen in Glas extra hell weiss oder graphit lackiert, oder in Glas extra hell geätzt und weiss oder graphit lackiert. Die Platte in 12mm ist auf die Basis gelegt.

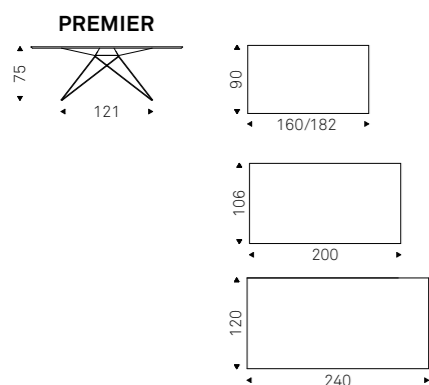
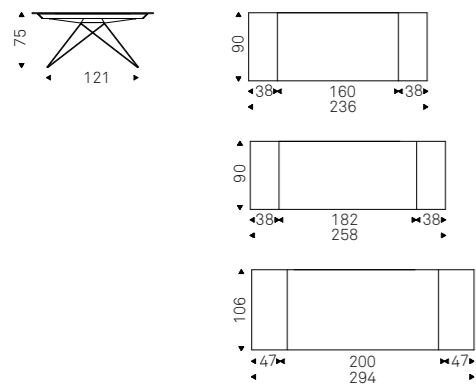

PREMIER WOOD DRIVE

Design

A. Lucatello & G. Cattelan

Tavolo allungabile con base in acciaio verniciato gofrato titanio, nero, graphite. Piano e prolunghe con bordi obliqui in legno noce Canaletto o rovere bruciato.

Extendible table with base in titanium, black or graphite embossed lacquered steel. Top and extensions with angled edges in Canaletto walnut or burned oak.

Table à rallonges avec base en acier gaufré titane, noir ou graphite. Plateau et rallonges avec bords biseautés en noyer Canaletto ou rouvre brûlé.

Mesa extensible con base en acero barnizado gofrado titanio, negro o graphite. Sobre y extensiones con bordes oblicuos en madera nogal Canaletto o roble ahumado.

Ausziehbarer Esstisch mit Basis in Edelstahl lackiert titan, schwarz oder graphit gaufriert. Platte und Verlängerungen mit schräge Kanten in Nussbaum Canaletto oder "verbrannte Eiche".

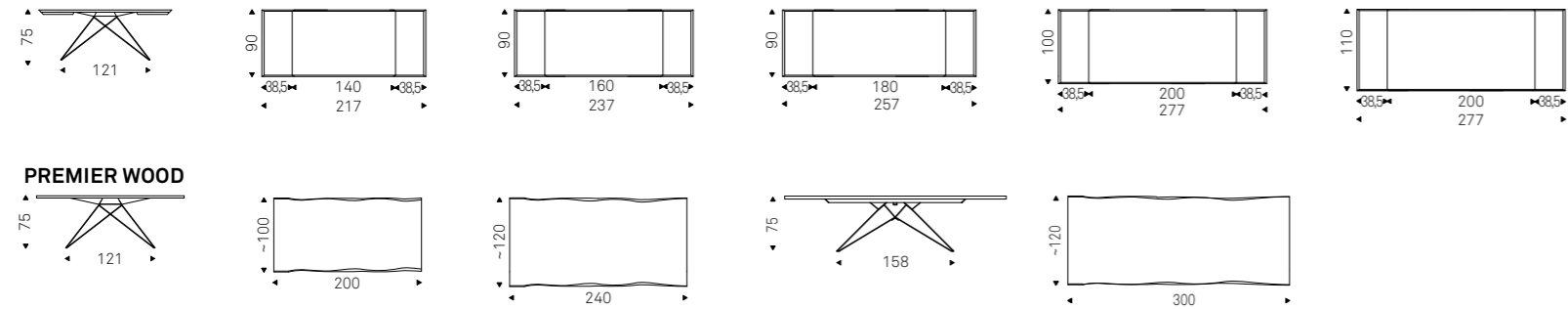

PREMIER WOOD

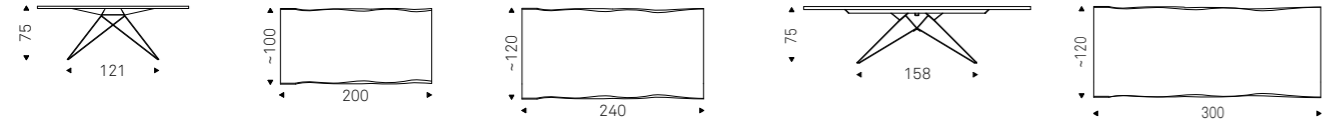

Black base, burned oak wood top





PREMIER WOOD DRIVE table with graphite base, burned oak wood top - ISABEL chairs in soft leather 953 Ardesia - BYBLOS lamp
 HAWAII mirror B, E - ABSOLUT sideboard with covered doors in soft leather 974 Capri

STRATOS WOOD**Design Studio Kronos**

Tavolo con base in acciaio verniciato gofrato titanio, graphite, nero.

Versione "S" con bordi irregolari in massello di noce Canaletto, rovere bruciato o rovere naturale spessore 4cm.

Versione "A": piano con bordi obliqui in noce Canaletto, rovere Heritage o rovere naturale. Il piano 200x100 ha lo spessore di 4cm, il 240x120 e il 300x120 di 5cm.

Versione "B": piano a botte con bordi bisellati in noce Canaletto o rovere bruciato.

Table with base in titanium, black or graphite embossed lacquered steel.

Top "S" version 4cm thick with irregular solid wood edges in Canaletto walnut, burned oak or natural oak.

Version "A": top with angled edges in Canaletto walnut, Heritage oak or natural oak. Wooden top 4cm on 200x100 version and 5cm on 240x120 and 300x120 versions.

Version "B": barrel top with bevelled edges in Canaletto walnut or burned oak.

Table avec base en acier gaufré titane, noir, graphite.

Version "S" avec bords irréguliers en bois massif noyer Canaletto, rovere brulé ou rovere naturel en épaisseur 4 cm.

Version "A": plateau en noyer Canaletto, rovere Heritage ou rovere naturel avec bords biseautés. Plateau 200x100 avec épaisseur 4cm, plateau 240x120 et 300x120 avec épaisseur 5 cm.

Version "B": plateau avec bords biseautés en noyer Canaletto ou rovere brulé.

Mesa con base en acero barnizado gofrado titanio, negro o graphite.

Versión "S" con bordes irregulares de madera maciza en nogal Canaletto, roble ahumado o roble natural grosor 4 cm.

Versión "A": sobre en nogal Canaletto, roble Heritage o roble natural con bordes oblicuos. Sobre 200x100 con grosor 4 cm, sobre medidas 240x120 y 300x120 grosor 5 cm.

Versión "B": sobre con bordes oblicuos en nogal Canaletto o roble ahumado.

Esstisch mit Basis in Edelstahl lackiert titan, schwarz oder graphit gaufriert.

Version "S" mit unregelmäßigen Kanten in massives Holz Nussbaum Canaletto oder "verbrannte Eiche" oder Eiche Natur. Dicke der Platten 4 cm.

Version "A": Platte in Nussbaum Canaletto, Eiche Heritage oder Natur Eiche mit schräge Kanten. Die Platte 200x100 hat 4 cm Dicke, die Platten in 240x120 und 300x120 haben 5 cm Dicke.

Version "B": Platte mit schräge Kanten aus Nussbaum Canaletto oder "verbrannte Eiche".

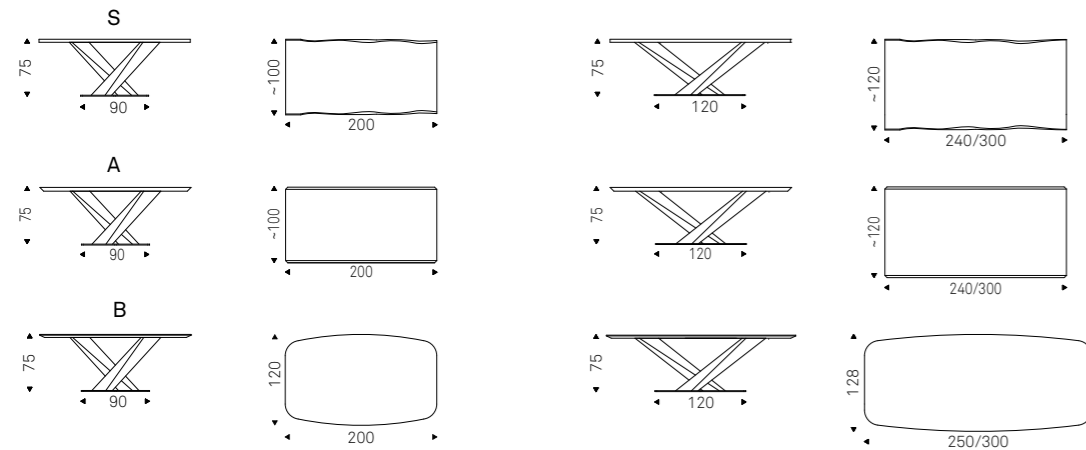

black base, Canaletto walnut top version A



STRATOS WOOD table with black base, burned oak top version B - ARCADIA COUTURE chairs in soft leather 948 Lino, wenghe frame - POSEIDON lamp 18 in matt black frame



STRATOS WOOD table with black base, burned oak top version B - ARCADIA COUTURE chairs in soft leather 948 Lino, wenghe frame
 ROYALTON sideboard in titanium - REGAL mirror fume - POSEIDON lamps 18 in matt black frame



STRATOS WOOD table with black base, Canaletto walnut top version S - DUMBO chairs in soft leather 973 Nero and matt black frame - RAVEL lamps

STRATOS KERAMIK**Design Studio Kronos**

Tavolo con base in acciaio verniciato gofrato titanio, graphite, nero. Piano in ceramica Marmi nei colori Calacatta, Alabastro, Ardesia, Golden Calacatta opaco, Golden Calacatta lucido, Portoro opaco, Portoro lucido o ceramica Brown Zinc. Piano in appoggio.

Table with base in titanium, black or graphite embossed steel. Marmi Calacatta, Alabastro, Ardesia, matt Golden Calacatta, glossy Golden Calacatta, matt Portoro, glossy Portoro or Brown Zinc ceramic top. The top is laid on the base.

Table avec base en acier gaufré titane, noir ou graphite. Plateau en céramique Marmi dans les couleurs Calacatta, Alabastro, Ardesia, Golden Calacatta opaque, Golden Calacatta brillant, Portoro opaque, Portoro brillant ou Brown Zinc. Plateau en appui.

Mesa con base en acero barnizado gofrado titanio, negro o graphite. Sobre en cerámica Marmi colores Calacatta, Alabastro, Ardesia, Golden Calacatta mate, Golden Calacatta brillo, Portoro mate, Portoro brillo o cerámica Brown Zinc. Sobre en apoyo.

Esstisch mit Basis in Edelstahl lackiert titan, schwarz oder graphit gaufriert. Platte in Keramik Marmi Calacatta, Alabastro, Ardesia, matt Golden Calacatta, glänzend Golden Calacatta, matt Portoro, glänzend Portoro oder Keramik Brown Zinc. Platte auf die Basis gelegt.

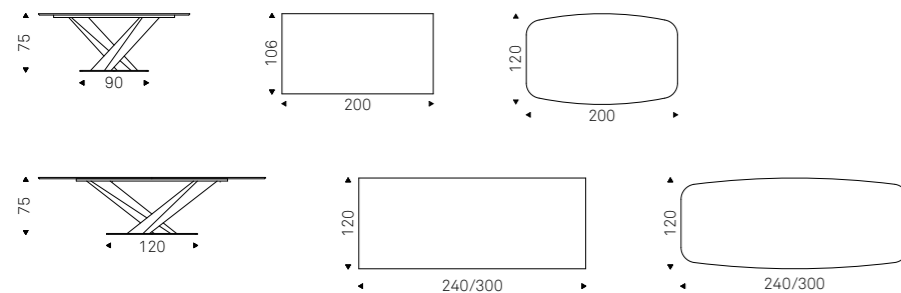

black base, Brown Zinc ceramic top



STRATOS KERAMIK table with titanium base, matt Golden Calacatta ceramic top - ARCADIA COUTURE chairs in soft leather 952 Smoke, wenghè frame
HUDSON bookcase in burned oak - MUMBAI rugs - POSEIDON lamps 18 in matt black frame



STRATOS KERAMIK table with titanium base, matt Golden Calacatta ceramic top - ARCADIA COUTURE chairs in soft leather 948 Lino and wenghé frame
 HUDSON bookcases in burned oak - MUMBAI rugs - POSEIDON lamps 18 in matt black frame



STRATOS KERAMIK table with titanium base - Portoro glossy ceramic top - MAGDA and MAGDA B chairs in soft leather 953 Ardesia and wenghe frame
 TIFFANY sideboards in soft leather 956 Atlantico - MUMBAI rugs - POSEIDON lamps 24 in matt black frame

SPYDER

Design Philip Jackson

Tavolo con base in acciaio verniciato opaco bianco, nero, graphite, ottone anticato, inox lucido, bronzo satinato, titanio satinato, noce Canaletto, dark wenghè o Rovere Heritage. Piano in appoggio in cristallo 15mm trasparente o trasparente extrachiaro. I piani 182x90 e 200x106 hanno spessore 12mm.

Table with base in matt white, black or graphite painted steel, or in wheathered brass or polished stainless steel, or in satin bronze, satin titanium painted steel, or with wooden base in Canaletto walnut, dark Wenghè or Heritage oak. Top in 15mm clear or extra clear glass, laid on the base. Glass top 12mm on 200x106 and 182x90 version.

Table avec base en acier laqué blanc opaque, noir opaque, graphite opaque, laiton antique, inox brillant, bronze satiné, titane satiné, noyer Canaletto, dark wenghè ou rouvre Heritage. Plateau en appui en verre 15mm clair ou extra-clair. Version 182x90 et 200x106 épaisseur 12mm.

Mesa con base en acero barnizado mate blanco, negro, graphite, latón, acero inox brillo, bronce satinado, titanio satinado, nogal Canaletto, dark wenghè o roble Heritage. Sobre en apoyo en cristal 15 mm transparente o transparente extraclaro. Los sobres 182x90 y 200x106 son de 12 mm.

Tisch mit Basis aus lackiertem Stahl matt weiß, matt schwarz, matt graphit, Messing antik, glänzendem Edelstahl, Bronze satiniert, Titan satiniert oder Nussbaum Canaletto, dark Wenghè oder Eiche Heritage. Transparentes oder Opti-Whitel transparentes Glas 15mm. Die Platte in der Größe 182x90 und 200x106 hat eine Dicke von 12mm. Platte ohne Befestigung auf der Basis.

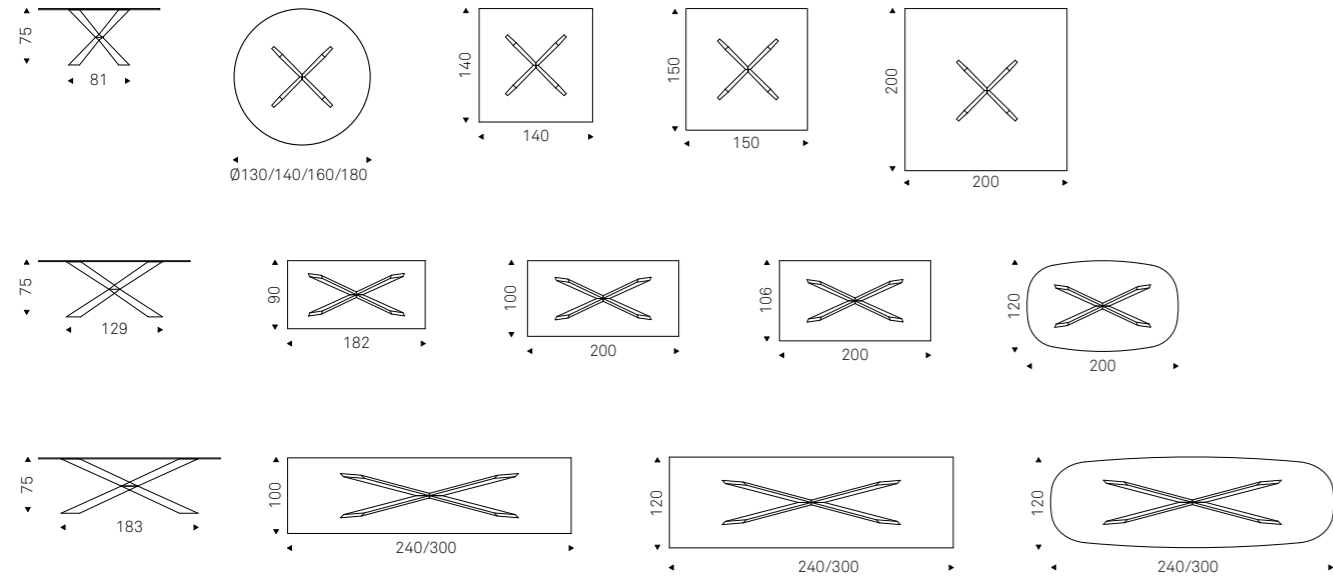

satin bronze base, extra clear glass top



satin titanium base, extra clear glass top



SPYDER table with satin titanium base, extra clear glass top - MAGDA B chairs in soft leather 947 Oyster and wenghé stained oak frame - APOLLO 8 R oval lamps



SPYDER table with graphite base, extra clear glass top - ARCADIA chairs in soft leather 953 Ardesia and Canaletto walnut frame - GALAXY lamps - REGAL mirrors - MAPOON rugs

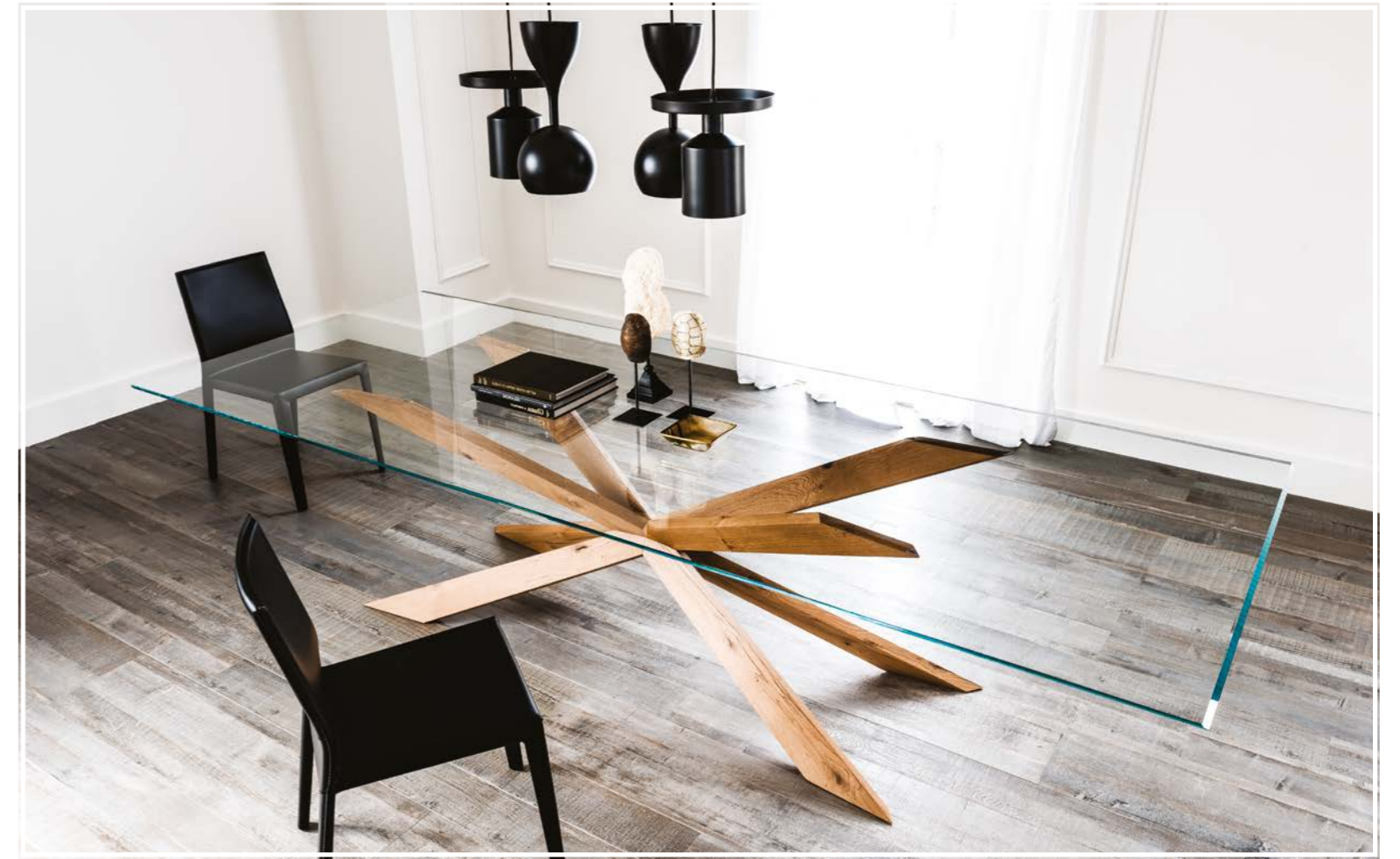

SPYDER table with Heritage oak base, extra clear glass top - MARGOT chairs in leather 73 Nero - HAVANA lamps

SPYDER KERAMIK

Design Philip Jackson

Tavolo con base in acciaio verniciato opaco bianco, nero, graphite, ottone anticato, inox lucido, bronzo satinato, titanio satinato, noce Canaletto, dark wenghè o Rovere Heritage. Piano in appoggio in Ceramica Marmi nei colori Calacatta, Alabastro, Ardesia, Golden Calacatta opaco, Golden Calacatta lucido, Portoro opaco, Portoro lucido o ceramica Brown Zinc. Optional vassoio centrotavola girevole Lazy Susan.

Table with base in matt white, black or graphite painted steel, or in wheated brass or polished stainless steel, or in satin bronzed, satin titanium painted steel, or with wooden base in Canaletto walnut, dark Wenghè or Heritage oak. Laying top in ceramic Marmi dans les couleurs Calacatta, Alabastro, Ardesia, Golden Calacatta, Alabastro, Ardesia, matt Golden Calacatta, glossy Golden Calacatta, matt Portoro, glossy Portoro or Brown Zinc ceramic top. Optional central swivelling tray Lazy Susan.

Table avec base en acier laqué blanc opaque, noir opaque, graphite opaque, graphite mate, latón, acero inox brillo, bronze satinado, titanio satinado, nogal Canaletto, dark wenghè o roble Heritage. Sobre en apoyo en cerámica colores Calacatta, Alabastro, Ardesia, Golden Calacatta mate, Golden Calacatta brillo, Portoro mate, Portoro brillo o cerámica Brown Zinc. Opcional bandeja sobremesa giratoria Lazy Susan.

Mesa con base en acero barnizado blanco, negro, graphite mate, latón, acero inox brillo, bronze satinado, titanio satinado, nogal Canaletto, dark wenghè o roble Heritage. Sobre en apoyo en cerámica colores Calacatta, Alabastro, Ardesia, Golden Calacatta mate, Golden Calacatta brillo, Portoro mate, Portoro brillo o cerámica Brown Zinc. Opcional bandeja sobremesa giratoria Lazy Susan.

Tisch mit Basis aus lackiertem Stahl matt weiß, matt schwarz, matt graphit, Messing antik, glänzendem Edelstahl, Bronze satiniert, Titan satiniert oder Nussbaum Canaletto, dark wenghè oder Eiche Heritage. Platte in Keramik Marmi in den Farben Calacatta, Alabastro, Ardesia, matt Golden Calacatta, glänzend Golden Calacatta, matt Portoro, glänzend Portoro oder Keramik Brown Zinc. Optional drehbare Tablett Lazy Susan.

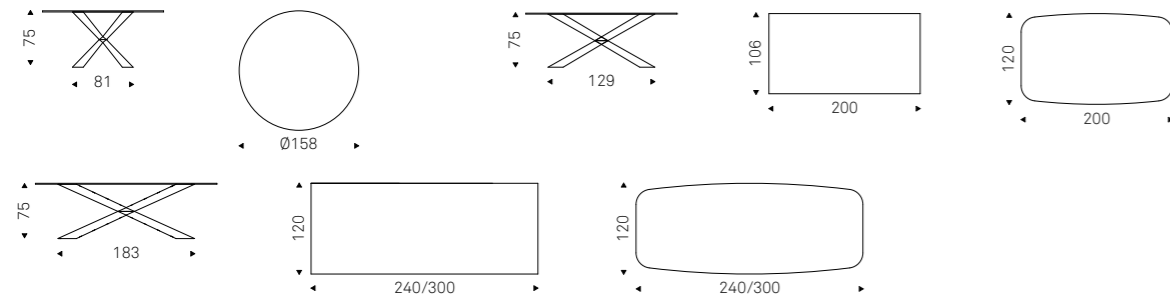

satin titanium base, Alabastro ceramic top



satin titanium base, matt Golden Calacatta ceramic top



satin titanium base, Zinc Brown ceramic top



satin bronze base, Ardesia ceramic top



SPYDER KERAMIK table with satin titanium base, Calacatta ceramic top, ISABEL chairs in soft leather 943 Moka - STILO lamps in black chrome steel

GORDON

Design **Giorgio Cattelan**

Tavolo con base in acciaio verniciato trasparente, goffrato titanio, bianco, nero o graphite. Piano in appoggio in cristallo 15mm trasparente, trasparente extrachiaro o trasparente extrachiaro con bordi bisellati inversi (versione rettangolare) o bisellati (versione rotonda). I piani 182x90 e 200x106 hanno spessore 12mm.

Table with transparent varnished metal base, titanium, white, black or graphite embossed lacquered steel. Top in 15mm clear, extra clear or extra clear glass with reversed bevelled edges (rectangular version) or only bevelled (round version). Glass top 12mm on 182x90 and 200x106 versions. The top is laid on the base.

Table avec base en acier laqué transparent, gaufré titane, blanc, noir ou graphite. Plateau en verre clair 15 mm, extra-clair ou extra-clair avec bords biseautés inversés (version rectangulaire) ou bords biseautés (version ronde). Les plateaux 182x90 et 200x106 ont épaisseur 12mm. Plateau d'appui.

Mesa con base en acero barnizado transparente, gofrado titanio, blanco, negro o graphite. Sobre en cristal 15mm transparente, transparente extraclaro o transparente extraclaro con bordes biselados inversos (versión rectangular) o biselados (versión redonda). Los sobres 182x90cm y 200x106cm son de 12mm. Sobre en apoyo.

Esstisch mit Basis aus Stahl lackiert transparent, Titan, weiß, schwarz oder graphite gaufriert. Platte in 15mm Glas transparent, extra hell transparent, oder extra hell mit Kanten umgekehrt facettiert. Platten in 182x90 und 200x106 haben 12 mm Dicke. Platte auf die Basis gelegt.

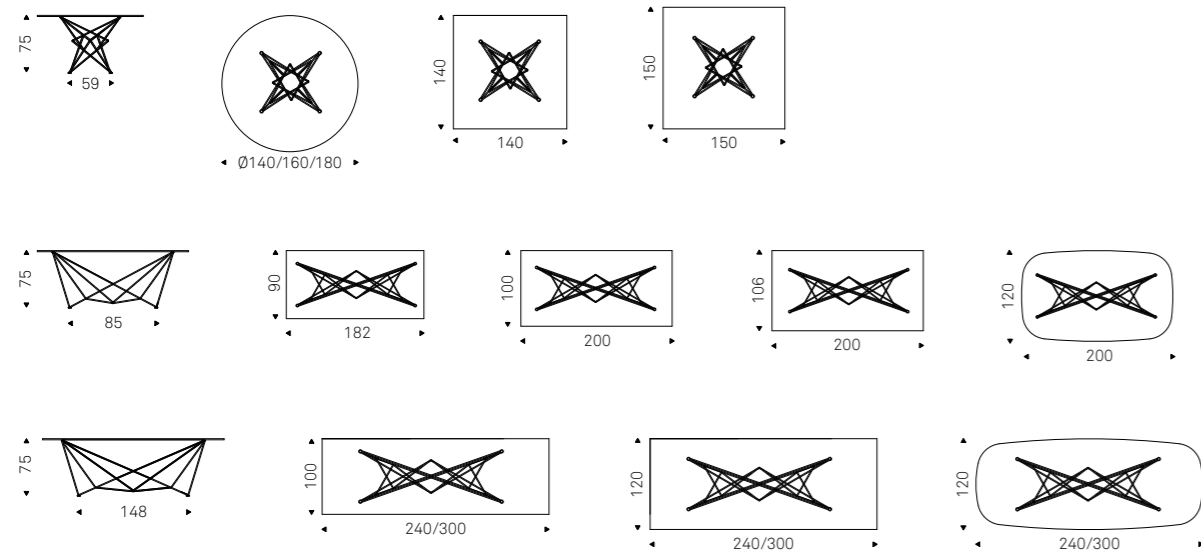

GORDON table with black base, extra clear glass top - INDY 101 chairs in polyurethane P04 Petrolio and graphite base - CLOUD lamps in fumé glass



GORDON table with black base, extra clear glass top - ARCADIA chairs in soft leather 948 Lino and Canaletto walnut frame - CELLINI S3 lamp

GORDON KERAMIK**Design Giorgio Cattelan**

Tavolo con base in acciaio verniciato trasparente, goffrato titanio, bianco, nero o graphite. Piano in ceramica Marmi nei colori Calacatta, Alabastro, Ardesia, Golden Calacatta opaco, Golden Calacatta lucido, Portoro opaco, Portoro lucido o ceramica Brown Zinc. Optional vassoio centrotavola girevole Lazy Susan.

Table with transparent varnished metal base, titanium, white, black or graphite embossed lacquered steel. Top in ceramic Marmi Calacatta, Alabastro, Ardesia, matt Golden Calacatta, glossy Golden Calacatta, matt Golden Calacatta, Portoro opaco, Portoro glossy Portoro or Brown Zinc ceramic top. Optional central swivelling tray Lazy Susan.

Table avec base en acier laqué transparent, gaufre titane, blanc, noir ou graphite. Plateau en céramique Marmi dans les couleurs Calacatta, Alabastro, Ardesia, Golden Calacatta opaque, Golden Calacatta brillante, Portoro opaque, Portoro brillant ou Brown Zinc. Optionnel plateau centre table pivotant Lazy Susan.

Mesa con base en acero barnizado transparente, gofrado titanio, blanco, negro o graphite. Sobre en cerámica Marmi en los colores Calacatta, Alabastro, Ardesia, Golden Calacatta mate, Golden Calacatta brillo, Portoro mate, Portoro brillo o cerámica Brown Zinc. Opcional bandeja sobremesa giratoria Lazy Susan.

Esstisch mit Basis aus Stahl lackiert transparent, Titan, weiß, schwarz oder graphite gaufriert. Platte in Keramik Marmi in den Farben Calacatta, Alabastro, Ardesia, matt Golden Calacatta, glänzend Golden Calacatta, matt Golden Calacatta, Portoro oder Keramik Brown Zinc. Optional drehbare Tablett Lazy Susan.

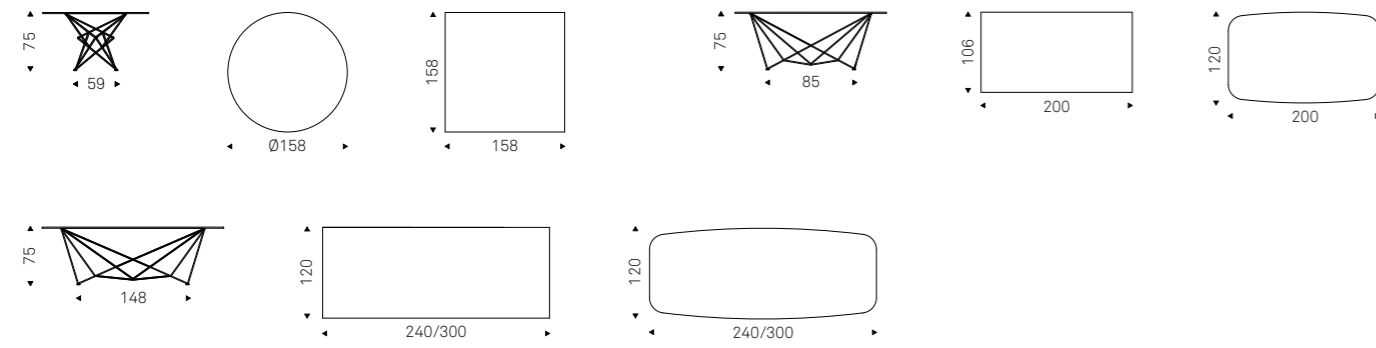

black base, matt Golden Calacatta ceramic top



black base, Zinc Brown ceramic top



black base, Ardesia ceramic top



GORDON KERAMIK table with black base, Calacatta ceramic top - MAGDA B chair in soft leather 948 Lino and wenghe stained oak frame - CLOUD lamps in Iride glass - MAPOON rug





table GORDON KERAMIK base black, top keramik alabastro - chairs MAGDA B soft leather 949 lino, Canaletto walnut frame



GORDON KERAMIK table with black base, Calacatta ceramic top

GORDON DEEP WOOD

Design **Giorgio Cattelan**

Tavolo con base in acciaio verniciato trasparente, gofrato titanio, bianco, nero o graphite. Piano in legno con bordi irregolari in massello in noce Canaletto, spessore 8cm.

Table with transparent varnished metal base, titanium, white, black or graphite embossed lacquered steel. 8cm thick wooden top with irregular solid wood edges in Canaletto walnut.

Table avec base en acier laqué transparent, gaufré titane, blanc, noir ou graphite. Plateau avec bords irréguliers en bois massif noyer Canaletto, épaisseur 8 cm.

Mesa con base en acero barnizado transparente, gofrado titanio, blanco, negro o graphite. Sobre en madera con cantos irregulares en nogal Canaletto macizo. Grosor 8 cm.

Esstisch mit Basis aus Stahl lackiert transparent, Titan, weiß, schwarz oder graphite gaufriert. Platte mit irregelmessigen Kanten in massives Holzes Nussbaum Canaletto.

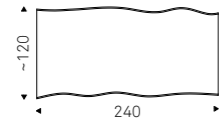
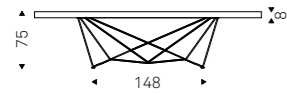

GORDON DEEP WOOD table with titanium base, top Canaletto walnut - AGATHA FLEX chairs in soft leather 942 Fango - GLENN mirrors bronze - CRISTAL S2 lamp - MAPOON rugs



GORDON DEEP WOOD table with graphite base, top Canaletto walnut - SOFIA chairs in soft leather 948 Lino and Canaletto walnut frame - BYBLOS lamp

KLIRR**Design Emanuele Zenere**

Tavolo con gambe in cristallo curvato trasparente 15mm. Piano in cristallo 15mm trasparente, trasparente extrachiaro o trasparente extrachiaro con bordi bisellati inversi. Trave centrale in massello di noce Canaletto, frassino tinto rovere bruciato o frassino laccato poro aperto nero opaco.

Table with 15mm clear curved glass legs. Top in 15mm clear, extra clear or extra clear glass with reversed bevelled edges. Central beam in solid Canaletto walnut or open pore ashwood stained in burned oak or matt black.

Table avec pieds en verre clair courbé 15mm. Plateau en verre clair 15 mm, extra-clair ou extra-clair avec bords biseautés inversés. Poutre centrale en bois de noyer Canaletto massif ou frêne teinté rouvre brûlé ou laqué noir opaque pore ouvert.

Mesa con patas en cristal 15mm transparente curvado. Sobre en cristal 15mm transparente, transparente extraclaro o transparente extraclaro con bordes biselados inversos. Viga central en macizo de nogal Canaletto o fresno barnizado roble ahumado o barnizado a poro abierto negro mate.

Tisch mit gebogenen Füßen aus 15mm Klarglas. Platte aus 15 mm Glas transparent, extra hell transparent oder extra hell mit Kanten umgekehrt facettiert. Holm aus Massivem Nussbaum Canaletto, Esche verbrannte Eiche lackiert oder Esche offenporig matt schwarz lackiert.

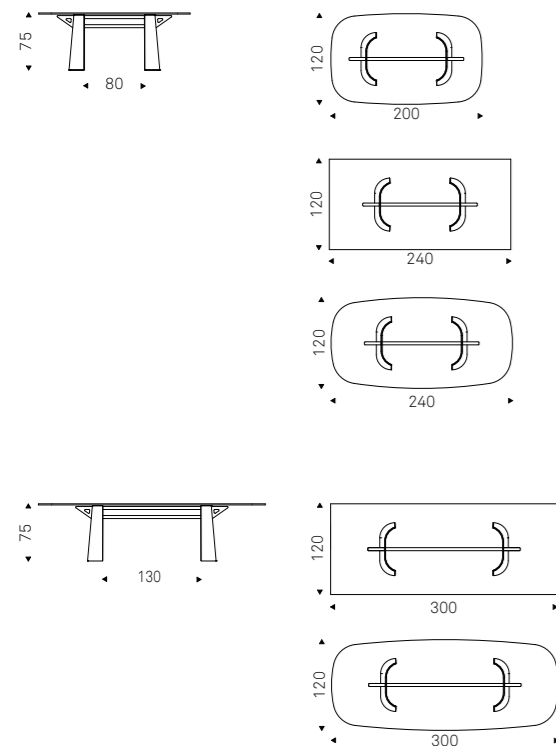

KLIRR table extra clear glass top, black beam - DUMBO chair in soft leather 973 Nero and matt black fr73 frame
POSEIDON 24 lamp in black finish - TIFFANY sideboards in soft leather 956 atlantico - MUMBAY rugs



KLIRR table extra clear glass top, black beam - DUMBO chair in soft leather 973 Nero and matt black 1173 nero
 POSEIDON 24 lamp in black finish - MUMBAY rugs

ROLL KERAMIK

Design **Paolo Cattelan**

Tavolo con gambe in acciaio verniciato gofrato titanio o nero e particolari in cromo nero. Piano in ceramica Marmi nei colori Calacatta, Alabastro, Ardesia, Golden Calacatta opaco, Golden Calacatta lucido, Portoro opaco, Portoro lucido o ceramica Brown Zinc. Versione 3 con 2 gambe piccole e 1 grande, versione 4 con 2 gambe piccole e 2 grandi. Optional gamba piccola aggiuntiva.

Table with titanium or black embossed lacquered steel legs and details in black chrome steel. Top in ceramic Marmi in Calacatta, Alabastro, Ardesia, matt Golden Calacatta, glossy Golden Calacatta, matt Portoro, glossy Portoro or Brown Zinc. 3 version with with 1 big and 2 small legs, 4 version with 2 big and 2 small legs. Optional additional small leg.

Table avec base en acier gaufré titane ou noir et détails en acier chromé noir. Plateau en céramique Marmi dans les couleurs Calacatta, Alabastro, Ardesia, Golden Calacatta opaque, Golden Calacatta brillante, Portoro opaque, Portoro brillant ou Brown Zinc. Version 3 avec 1 grande et 2 petites pieds, version 4 avec 2 grandes et 2 petites pieds. Optionnel petite pied additionnel.

Mesa con base en acero gofrado titanio o negro y detalles en acero cromo negro. Sobre en cerámica Marmi colores Calacatta, Alabastro, Ardesia, Golden Calacatta mate, Golden Calacatta brillo, Portoro mate, Portoro brillo o cerámica Brown Zinc. Versión 3 con 1 pata grande y 2 patas pequeñas, versión 4 con 2 patas grandes y 2 patas pequeñas. Opcional pata pequeña.

Esstisch mit Basis aus Metall lackiert titan oder schwarz gaufriert. Details aus schwarz verchromtem Stahl. Platte in Keramik Marmi in den Farben Calacatta, Alabastro, Ardesia, matt Golden Calacatta, glänzend Golden Calacatta, matt Portoro, glänzend Portoro oder Keramik Brown Zinc. 3 Version mit 1 großen und 2 kleinen Beinen, 4 Version mit 2 großen und 2 kleinen Beinen. Option 1 kleine Bein. Beinen.

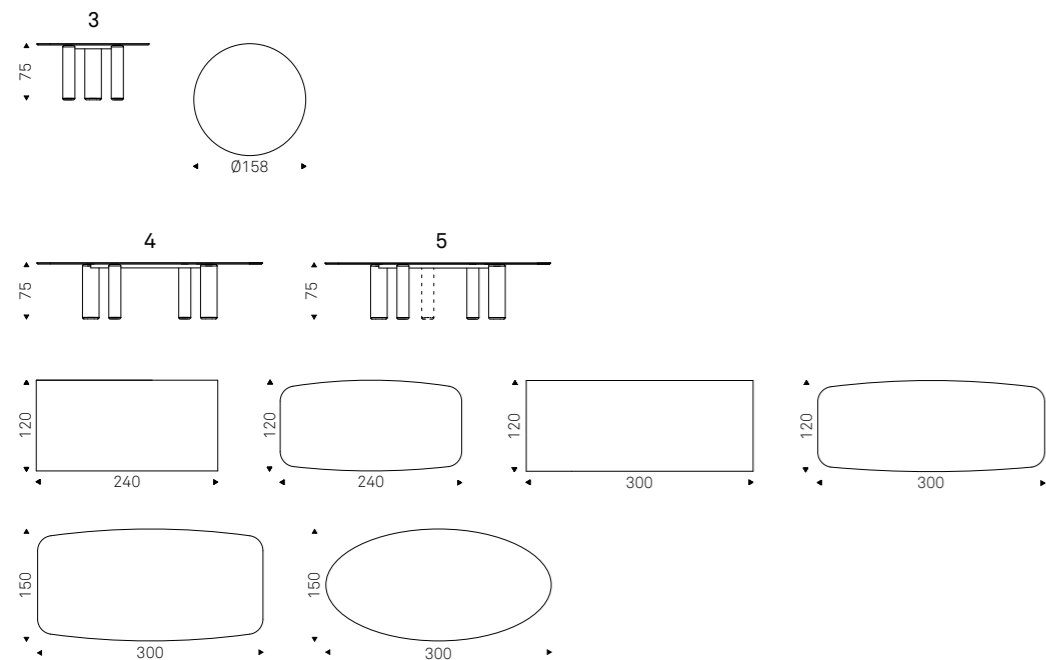

5 black legs, glossy Portoro ceramic top



ROLL KERAMIK table with 5 black bases, Alabastro ceramic top - MAGDA B chairs in soft leather 948 Lino - APOLLO lamps - RUBIK rugs - TIFFANY sideboard in soft leather 956 Atlantico



ROLL KERAMIK table with 4 black legs, Alabastro ceramic top - ARCADIA COUTURE chairs in soft leather 948 Lino and wenghé frame - POSEIDON lamp 24 in matt black frame



black legs, Calacatta ceramic top



black legs, matt Golden Calacatta ceramic top



black legs, Ardesia top



ROLL KERAMIK table 300x150 with 4 black legs, Zinc Brown ceramic top - NORMA COUTURE H chairs in soft leather 953 Ardesia - POSEIDON lamp 24 in matt black frame

ROLL ROUND

Design **Paolo Cattelan**

Tavolo con gambe in acciaio verniciato gofrato titanio o nero e particolari in cromo nero. Piano con o senza bisello in cristallo 15mm trasparente o trasparente extrachiaro. Piano con o senza bisello in cristallo 12mm temperato fumé. Versione ø140 con 3 gambe piccole, ø160 e ø180 con 2 gambe piccole e una grande.

Table with titanium or black embossed lacquered steel legs and details in black chrome steel. Top with or without bevelled edge in 15mm clear or extra clear glass. Top with or without bevelled edge in 12mm fumé tempered glass. ø140 version with 3 small legs, ø160 and ø180 versions with 1 big and 2 small legs.

Table avec base en acier gaufré titane ou noir et détails en acier chromé noir. Plateau avec ou sans bord biseauté en verre clair ou extra-clair 15mm. Plateau avec ou sans bord biseauté en verre fumé trempé 12mm. Version ø140 avec 3 petites pieds, versions ø160 et ø180 avec 1 grande et 2 petites pieds.

Mesa con base en acero gofrado titanio o negro y detalles en acero cromo negro. Sobre con o sin borde biselado en cristal 15mm transparente o transparente extraclaro. Sobre con o sin borde biselado en cristal 12mm templado fumé. Versión ø140 con 3 patas pequeñas, versiones ø160 y ø180 con 1 pata grande y 2 patas pequeñas.

Esstisch mit Basis aus Metall lackiert titan oder schwarz gaufriert. Details aus schwarz verchromtem Stahl. Platte mit oder ohne Kanten facettiert in 15mm Glas transparent oder extra hell transparent. Platte mit oder ohne Kanten facettiert in 12mm Sicherheitsglas fumé. ø140 Version mit 3 kleinen Beinen, ø160 und ø180 Versionen mit 1 großen und 2 kleinen Beinen.

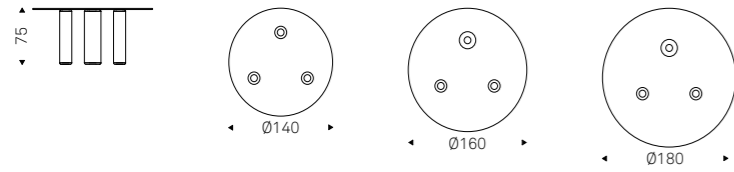

titanium legs - extra clear bevelled glass top



ROLL ROUND table with black legs, fumé bevelled glass top - DUMBO chairs in soft leather 948 Lino and black frame (Fr73)
CLOUD lamps in smoked grey glass - TIFFANY sideboard in soft leather 956 Atlantico - SABLIER abat-jour in mixed glass (iride-fumé)

ROLL WOOD ROUND

Design **Paolo Cattelan**

Tavolo con gambe in acciaio verniciato gofrato titanio o nero e particolari in cromo nero. Piano in legno noce Canaletto o rovere bruciato.

Table with titanium or black embossed lacquered steel legs and details in black chrome steel. Top in Canaletto walnut or burned oak.

Table avec base en acier gaufré titane ou noir et détails en acier chromé noir. Plateau en noyer Canaletto ou rouvre brûlé.

Mesa con base en acero gofrado titanio o negro y detalles en acero cromo negro. Sobre en madera nogal Canaletto o roble ahumado.

Esstisch mit Basis aus Metall lackiert titan oder schwarz gaufriert. Details aus schwarz verchromtem Stahl. Platte in Nussbaum Canaletto oder "verbrannte Eiche".



ROLL WOOD ROUND table with black legs, burned oak top - ARCADIA COUTURE H chairs in soft leather 948 Lino and wenghe frame - ASIA lamps grey-bronze - AIRPORT bookcase

ROLL WOOD

Design **Paolo Cattelan**

Tavolo con 2 gambe piccole e 2 grandi in acciaio verniciato gofrato titanio o nero e particolari in cromo nero. Piano in legno noce Canaletto o rovere bruciato. Opzionale gamba piccola aggiuntiva.

Table with 2 big and 2 small legs in titanium or black embossed lacquered steel legs and details in black chrome steel. Top in Canaletto walnut or burned oak. Optional additional small leg.

Table avec 2 grandes et 2 petites pieds en acier gaufré titane ou noir et détails en acier chromé noir. Plateau en noyer Canaletto ou rouvre brulé. Optionnel petite pied additionnel.

Mesa con 2 patas grandes y 2 patas pequeñas en acero gofrado titanio o negro y detalles en acero cromo negro. Sobre en madera nogal Canaletto o roble ahumado. Opcional pata pequeña.

Esstisch mit 2 großen und 2 kleinen Beinen aus Metall lackiert titan oder schwarz gaufriert. Details aus schwarz verchromtem Stahl. Platte in Nussbaum Canaletto oder "verbrannte Eiche". Option 1 kleine Bein.

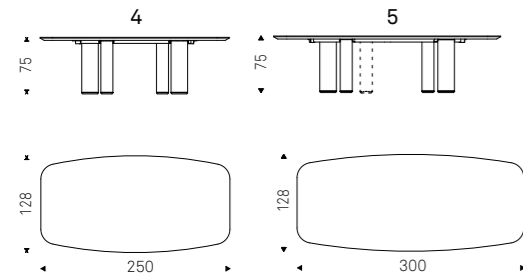



ROLL WOOD table with titanium legs, burned oak top - AURELIA chairs in soft leather 956 Atlantico
 CRISTAL S2 lamp - TIFFANY sideboard in soft leather 956 Atlantico - RADJA rugs

HYSTRIX

Design **Giorgio Cattelan**

Tavolo con base in acciaio verniciato trasparente e piastre goffrate graphite. Piano in appoggio in cristallo 15mm trasparente, trasparente extrachiario o trasparente extrachiario con bordi bisellati inversi.

Table with transparent varnished steel base and embossed graphite plates. Top in 15mm clear, extra clear or extra clear glass with reversed bevelled edges. The top is laid on the base.

Table avec base en acier laqué transparent et plaquettes gaufré graphite. Plateau en verre clair 15 mm, extra-clair ou extra-clair avec bords biseautés inversés. Plateau d'appui.

Mesa con base en acero barnizado transparente y pletinas gofrado graphite. Sobre en cristal 15mm transparente, transparente extraclaro o transparente extraclaro con bordes biselados inversos. Sobre en apoyo.

Esstisch mit Basis aus Stahl lackiert transparent und gaufrierten Graphit-Metalplättchen. Platte in 15mm Glas transparent, extra hell transparent, oder extra hell mit Kanten umgekehrt facettiert. Platte auf dem Basis gelegt.

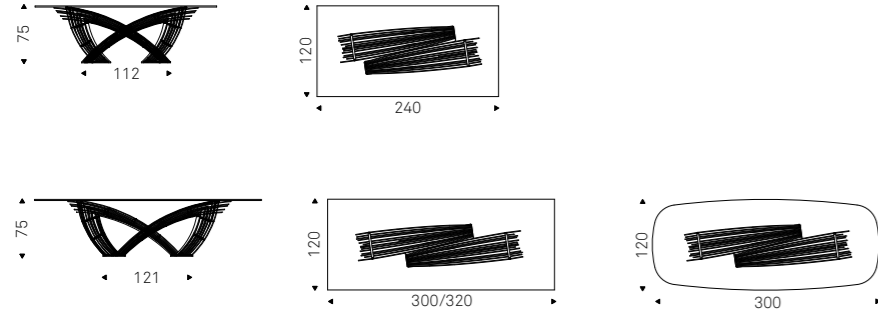

HYSTRIX table with graphite base, extra clear glass top - TYLER chairs in soft leather 942 Fango and Canaletto walnut frame (frNC) - CRISTAL S2 lamp

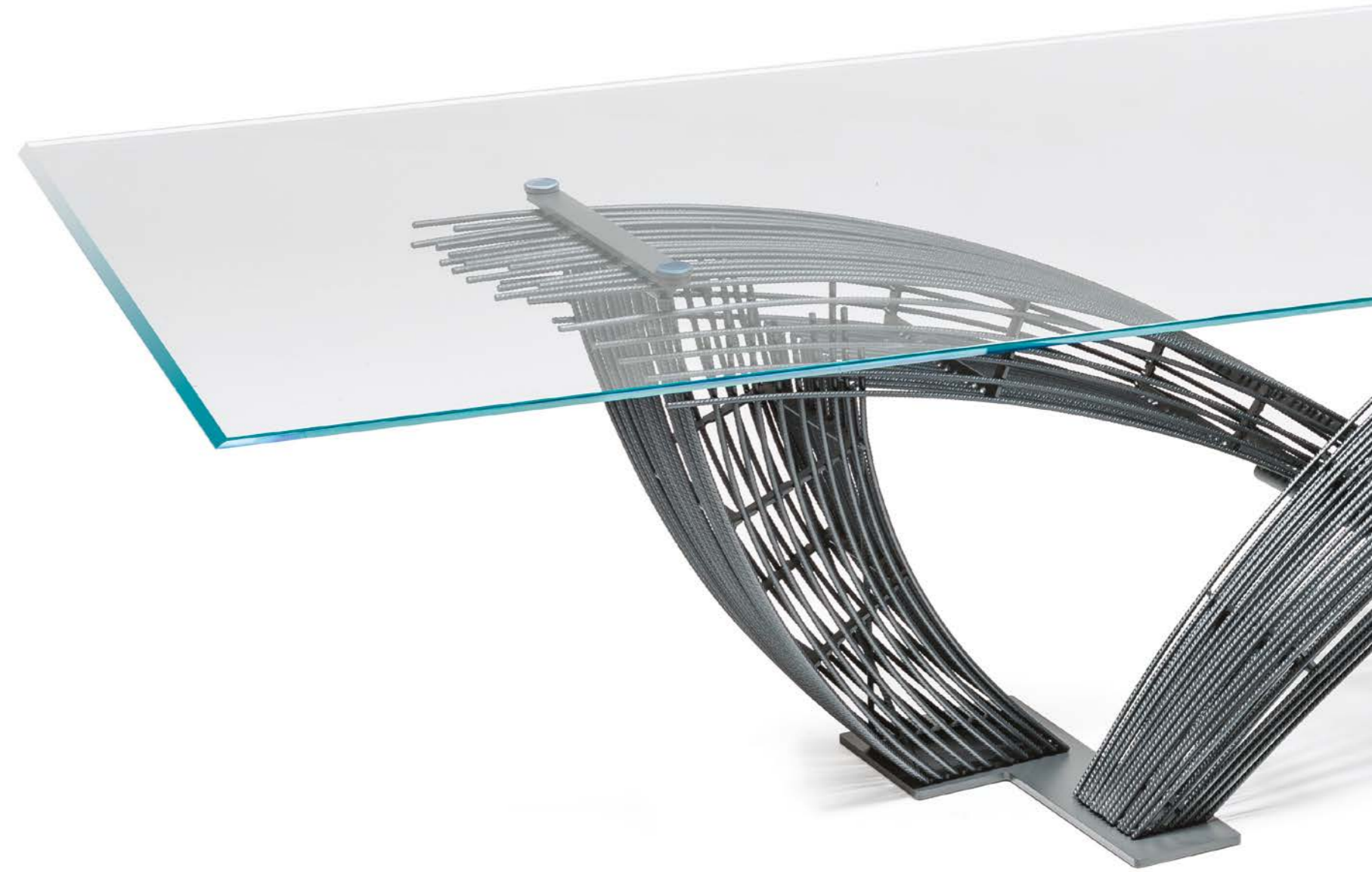

YODA KERAMIK**Design Paolo Cattelan**

Tavolo con base in acciaio verniciato gofrato bianco, nero, graphite o titanio satinato. Piano in ceramica Marmi nei colori Calacatta, Alabastro, Ardesia, Golden Calacatta opaco, Golden Calacatta lucido, Portoro opaco, Portoro lucido o ceramica Brown Zinc. Optional vassoio centrotavola girevole Lazy Susan.

Table with base in white, black, graphite embossed lacquered steel or satin titanium steel. Marmi Calacatta, Alabastro, Ardesia, matt Golden Calacatta, glossy Golden Calacatta, matt Portoro, glossy Portoro or Brown Zinc ceramic top. Optional central swivelling tray Lazy Susan.

Table avec base en acier verni gaufré blanc, noir, graphite ou titane satiné. Plateau en céramique dans les couleurs Marmi Calacatta, Alabastro, Ardesia, Golden Calacatta opaque, Golden Calacatta brillant, Portoro opaque, Portoro brillant ou Brown Zinc. Optionnel plateau centre table pivotant Lazy Susan.

Mesa con base en acero barnizado gofrado blanco, negro, graphite o titanio satinado. Sobre en cerámica Marmi colores Calacatta, Alabastro, Ardesia, Golden Calacatta mate, Golden Calacatta brillo, Portoro mate, Portoro brillo o cerámica Brown Zinc. Opcional bandeja sobremesa giratoria Lazy Susan.

Esstisch mit Basis in Stahl lackiert weiß, schwarz, graphite gaufriert oder Titan satiniertem. Keramikplatte in Keramik Marmi in den Farben Calacatta, Alabastro, Ardesia, matt Golden Calacatta, glänzend Golden Calacatta, matt Portoro, glänzend Portoro oder Keramik Brown Zinc. Optional drehbare Tablett Lazy Susan.

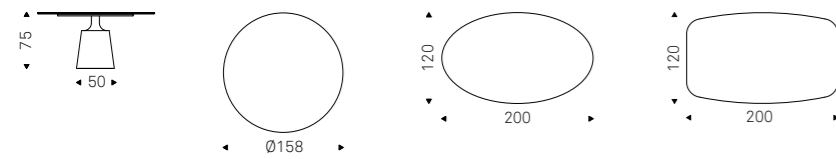

YODA KERAMIK table with satin titanium base, Ardesia ceramic top - ARCADIA chairs in soft leather 945 Safari and Canaletto walnut frame

**YODA KERAMIK**

YODA KERAMIK table with black base, Alabastro ceramic top - FLAMINIA A chair in soft leather 953 Ardesia and black frame - HAVANA A lamps



YODA KERAMIK table with titanium base, matt Golden Calacatta ceramic top - BETTY chairs in soft leather 980 Ottanio and black frame

YODA**Design Paolo Cattelan**

Tavolo con base in acciaio verniciato gofrato bianco, nero, graphite o titanio satinato. Piano con piastre in cristallo 15mm trasparente o trasparente extrachiaro con bordo bisellato.

Table with base in white, black, graphite embossed lacquered steel or satin titanium steel. Top with plates in 15mm clear or extra clear glass with bevelled edges.

Table avec base en acier verni gaufré blanc, noir, graphite ou titane satiné. Plateau en verre clair ou extra-clair 15 mm avec bord biseauté avec plaquettes.

Mesa con base en acero barnizado gofrado blanco, negro, graphite o titanio satinado. Sobre con pletinas en cristal transparente o transparente extraclaro con borde biselado 15mm.

Esstisch mit Basis in Stahl lackiert weiß, schwarz, graphite gaufriert oder Titan satiniertem. Glasplatte transparent oder extra-hell transparent facettiert, mit Metallplättchen, Dicke 15 mm.

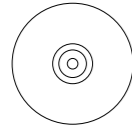
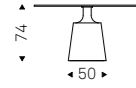

◀ Ø140/160 ▶



black base, extra clear glass top

YODA WOOD**Design Paolo Cattelan**

Tavolo con base in acciaio verniciato gofrato bianco, nero, graphite o titanio satinato. Piano in legno noce Canaletto o rovere bruciato. Nuvoletture sulla base in titanio satinato sono dovute alla lavorazione manuale. Optional vassoio centrotavola girevole Lazy Susan.

Table with base in white, black, graphite embossed lacquered steel or satin titanium steel. Top in Canaletto walnut or burned oak. Glazes on the satin titanium base are due to the handmade work. Optional central swivelling tray Lazy Susan.

Table avec base en acier verni gaufré blanc, noir, graphite ou titane satiné. Plateau en noyer Canaletto ou rovere brûlé. L'effet nuage sur la base en titane satiné est une caractéristique du travail manuel. Optionnel plateau centre table pivotant Lazy Susan.

Mesa con base en acero barnizado gofrado blanco, negro, graphite o titanio satinado. Sobre en madera nogal Canaletto o roble ahumado. Sombras en la base titanio satinado son detalles de la producción manual. Opcional bandeja sobremesa giratoria Lazy Susan.

Esstisch mit Basis in Stahl lackiert weiß, schwarz, graphite gaufriert oder Titan satiniertem. Holzplatte in Nussbaum Canaletto oder "verbrannte Eiche". Optional drehbare Tablett Lazy Susan.

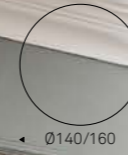

◀ Ø140/160 ▶



YODA WOOD table with satin titanium base, Canaletto walnut top - INDY 201 chairs in polyurethane P03 Fango and Canaletto walnut base
ZOOM lamps black chrome - EUROPA KERAMIK sideboard Alabastro - EXCALIBUR mirror



IPANEMA KERAMIK A table with black base, matt Golden Calacatta ceramic top - PIUMA EDITION chairs in leather 73 Nero ASIA lamps grey-bronze - ABSOLUT sideboard in soft leather 971 Bianco

IPANEMA KERAMIK

Design **Paolo Cattelan**

Tavolo con base in acciaio verniciato gofrato titanio, nero o graphite. Piano in ceramica Marmi nei colori Calacatta, Ardesia, Golden Calacatta opaco, Golden Calacatta lucido, Portoro opaco o Portoro lucido.

Table with titanium, black or graphite embossed steel base. Marmi ceramic Calacatta, Ardesia, matt Golden Calacatta, glossy Golden Calacatta, matt Portoro or glossy Portoro.

Table avec base en acier gaufré titane, noir ou graphite. Plateau en céramique Marmi dans les couleurs Calacatta, Ardesia, Golden Calacatta opaque, Golden Calacatta brillante, Portoro opaque ou Portoro brillant.

Mesa con base en acero barnizado gofrado titanio, negro o graphite. Sobre en cerámica Marmi colores Calacatta, Ardesia, Golden Calacatta mate, Golden Calacatta brillo, Portoro mate o Portoro brillo.

Tisch mit Basis aus Stahl lackiert titan, schwarz oder graphit gaufriert. Platte aus Keramik Marmi in den Farben Calacatta, Ardesia, matt Golden Calacatta, glänzend Golden Calacatta, matt Portoro oder glänzend Portoro.

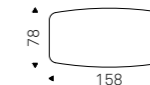
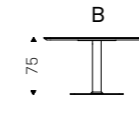
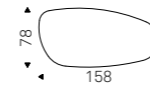
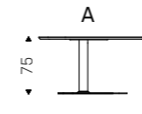

IPANEMA KERAMIK B titanium base, Calacatta ceramic

NIDO KERAMIK BISTROT

Design **Brogliato & Traverso**

Tavolo con base in acciaio verniciato gofrato bianco, nero o graphite. Piano in ceramica Marmi nei colori Calacatta, Alabastro Ardesia.

Table with white, black or graphite embossed steel base. Marmi Calacatta, Alabastro, Ardesia ceramic top.

Table avec base en acier gaufré blanc, noir ou graphite. Plateau en céramique Marmi dans les couleurs Calacatta, Alabastro, Ardesia.

Mesa con base en acero barnizado gofrado blanco, negro o graphite. Sobre en cerámica Marmi colores Calacatta, Alabastro, Ardesia.

Tisch mit Basis aus Stahl lackiert weiß, schwarz oder graphit gaufré. Platte aus Keramik Marmi in den Farben Calacatta, Alabastro, Ardesia.

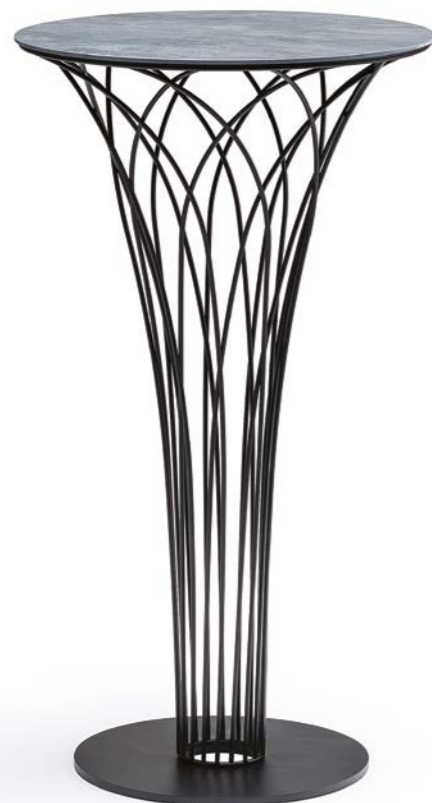
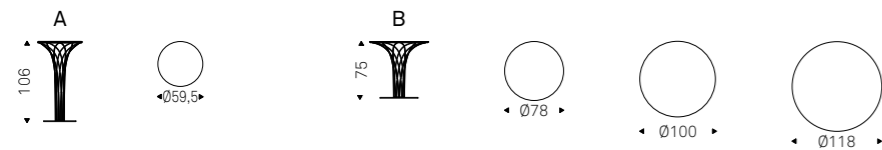

black base, Ardesia ceramic top A



black base, Alabastro ceramic top B



NIDO KERAMIK BISTROT B table with black base, Alabastro ceramic top - INDY 101 chairs in polyurethane P03 Fango and graphite base - VENEZIA 1 lamps



NIDO KERAMIK BISTROT B table with black base, Alabastro ceramic top - INDY 101 chairs in polyurethane P03 Fango and graphite base - VENEZIA 1 lamps

RALPH KERAMIK BISTROT

Design **Giorgio Cattelan**

Tavolo bistrot con base in acciaio verniciato trasparente, gofrato bianco, nero o graphite. Piano in ceramica Marmi nei colori Calacatta, Alabastro o Ardesia.

Bistrot table with transparent varnished metal base, white, black or graphite embossed lacquered steel. Marmi Calacatta, Alabastro or Ardesia ceramic top.

Table bistrot avec base en acier laqué transparent, gaufré blanc, noir ou graphite. Plateau en céramique Marmi dans les couleurs Calacatta, Alabastro ou Ardesia.

Mesa bistrot con base en acero barnizado transparente, gofrado blanco, negro o graphite. Sobre en cerámica Marmi colores Calacatta, Alabastro o Ardesia.

Bistrot Tisch mit Basis aus Metall lackiert transparent, weiß, schwarz oder graphite gaufriert. Platte in Keramik Marmi in den Farben Calacatta, Alabastro oder Ardesia.

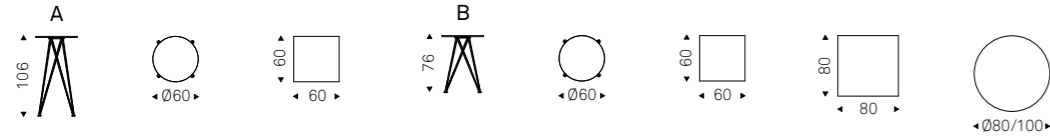

RALPH KERAMIK BISTROT B table with graphite base, Ardesia ceramic top - KAORI chairs in leather 42 Fango



RALPH KERAMIK BISTROT B table with graphite base, Alabastro ceramic top - KAORI chairs in leather 42 Fango

RALPH BISTROT**Design Giorgio Cattelan**

Tavolo bistrot con base in acciaio verniciato trasparente, goffrato bianco, nero o graphite. Piano in legno noce Canaletto, rovere bruciato o in cristallo trasparente temperato 12mm con piastre.

Bistrot table with transparent varnished metal base, white, black or graphite embossed lacquered steel. Top in Canaletto walnut, burned oak or 12mm tempered clear glass with plates.

Table bistrot avec base en acier laqué transparent, gaufré blanc, noir ou graphite. Plateau en bois noyer Canaletto, rovere brulé ou verre clair trempé 12mm avec plaquettes.

Mesa bistrot con base en acero barnizado transparente, gofrado blanco, negro o graphite. Sobre en nogal Canaletto, roble ahumado o en cristal transparente templado 12mm con pletinas.

Bistrot Tisch mit Basis aus Metall lackiert transparent, weiß, schwarz oder graphite gaufriert. Platte in Nussbaum Canaletto, "verbrannte Eiche" oder 12mm transparentem Sicherheitsglas mit Metallplättchen.



RALPH BISTROT A table with black base, extra clear glass top - ARCADIA stools in soft leather 952 Smoke and Canaletto walnut frame



RALPH BISTROT B table with black base, extra clear glass top - KAORI chair in leather 42 Fango

STRATOS CONSOLLE

Design Studio Kronos

Consolle con base in acciaio verniciato gofrato titanio, graphite o nero. Piano con bordi irregolari in massello di noce Canaletto, rovere bruciato o rovere naturale spessore 4cm.

Console with base in titanium, black or graphite embossed lacquered steel. Top with irregular solid wood edges in Canaletto walnut, burned oak or natural oak 4cm thick.

Console avec base en acier gaufré titane, noir ou graphite. Plateau avec bords irréguliers en bois massif noyer Canaletto, rovere brûlé ou rovere naturel en épaisseur 4 cm.

Consola con base en acero barnizado gofrado titanio, negro o graphite. Sobre con bordes irregulares de madera maciza en nogal Canaletto, roble ahumado o roble natural grosor 4 cm.

Konsole mit Basis aus Edelstahl lackiert titan, schwarz oder graphit gaufriert. Platte mit unregelmäßigen Kanten in massives Holz Nussbaum Canaletto oder "verbrannte Eiche" oder Eiche Natur. Dicke den Platten 4 cm.



graphite base, Canaletto walnut top



STRATOS CONSOLLE with titanium base, Canaletto walnut top - BYBLOS lamp



TREVI console with black base, Canaletto walnut top - HAWAII E mirrors - SABLIER A lamp in mixed glass (iride-fumè)

TREVI

Design Studio Kronos

Consolle con base in acciaio verniciato goffrato titanio o nero. Piano in noce Canaletto o rovere bruciato.

Console with base in titanium or black embossed lacquered steel. Top in Canaletto walnut or burned oak.

Console avec base en acier gaufré titane ou noir. Plateau en noyer Canaletto ou rouvre brulé.

Consola con base en acero barnizado gofrado titanio o negro. Sobre en nogal Canaletto o roble ahumado.

Konsole mit Basis aus Edelstahl lackiert titan oder schwarz. Platte aus Nussbaum Canaletto oder "verbrannte Eiche".

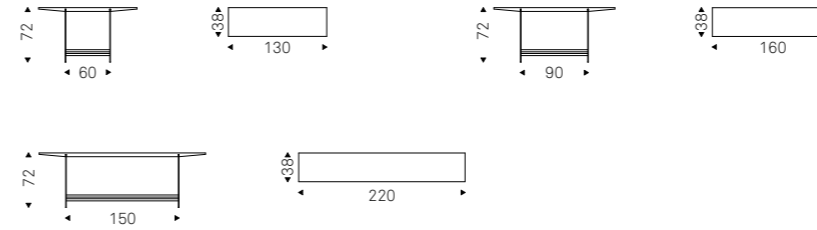

NASDAQ**Design Paolo Cattelan**

Scrivania con cassetiera in legno noce Canaletto, rovere Heritage o rovere laccato poro aperto nero opaco. Gamba in acciaio verniciato groffrato graphite. Nella versione 215x100 la cassetiera può essere fissata su entrambi i lati della scrivania, nella versione 260x120 solo dalla parte del lato corto.

Desk with drawers in Canaletto walnut, Heritage oak or open pore matt black oak. Leg in graphite embossed lacquered steel. On version 215x100 the drawer can be fixed on both sides of the desk, on version 260x120 it can be fixed only facing the shortest side.

Bureau avec tiroirs en noyer Canaletto, rouvre Heritage ou rouvre laqué noir opaque pore ouvert. Pied en acier gaufré graphite. Dans la version 215x100 les tiroirs peuvent être fixés sur les deux côtés du bureau. Dans la version 260x120, il est possible de les fixer seulement sur le côté plus court.

Escritorio con cajones en madera nogal Canaletto, roble Heritage o roble barnizado negro mate a poro abierto. Pata en acero barnizado gofrado graphite. En la versión 215x100 se puede fijar el cajón en ambos lados del escritorio, en la versión 260x120 sólo en el lado corto.

Schreibtisch mit Schubladen aus Nussbaum Canaletto, Eiche Heritage oder Eiche offenporig lackiert schwarz matt. Bein aus Stahl lackiert graphit gaufriert. In der Version 215x100 kann die Schublade in beiden Seiten dem Schreibtisch befestigt werden, in der Version 260x120, nur in der kürzere Seite.

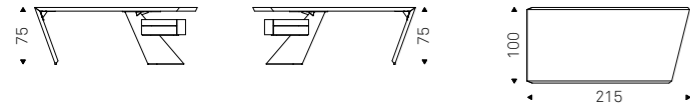

NASDAQ desk in Canaletto walnut - VITA C and VITA H chairs in soft leather 942 Fango and black base - SEVEN lamp - AIRPORT bookcase



NASDAQ desk in open pore matt black oak - INDY 101 T chair in polyurethane P03 Fango and graphite base - ISABEL H chair in soft leather 953 Ardesia - AIRPORT bookcase with black frame and burned oak shelves - MAMBA lamp black



NASDAQ desk in open pore matt black oak - INDY 101 T chair in polyurethane P03 Fango and graphite base - ISABEL H chair in soft leather 953 Ardesta
 AIRPORT bookcase with black frame and burned oak shelves - STEALTH lamp black



CLARION desk with graphite frame and Canaletto walnut top - MAGDA B chair in soft leather 953 Ardesia and Canaletto walnut (RNO) frame - THOR lamp in satin bronze steel

CLARION

Design **Andrea Lucatello**

Scrivania con cassetto. Struttura in acciaio verniciato gofrato nero o graphite e cromato. Piano in MDF laccato nero o graphite e noce Canaletto o rovere bruciato.

Desk with drawer with frame in graphite or black embossed lacquered steel and chromed stainless steel. Top in lacquered graphite or black embossed MDF and Canaletto walnut or burned oak.

Bureau avec tiroir. Structure en acier gaufré noir ou graphite et chromé. Plateau en mdf gaufré noir ou graphite et noyer Canaletto ou rouvre brulé.

Escritorio con cajón. Estructura en acero barnizado gofrado negro o graphite y acero cromado. Sobre en mdf barnizado gofrado negro o graphite y nogal Canaletto o roble ahumado.

Schreibtisch mit Schublade. Gestell aus Stahl lackiert schwarz oder graphite gaufriert und verchromt. Platte aus MDF schwarz oder graphite lackiert gaufriert und Nussbaum Canaletto oder "verbrannte Eiche".

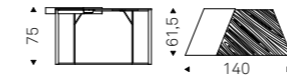



ARCADIA

Design **Paolo Cattelan**

Sedia con o senza braccioli con struttura in faggio naturale, tinto noce Canaletto, wenghè, bianco o nero opaco. Rivestimento in tessuto, synthetic nubuck, micro nubuck, ecopelle o pelle come da campionario. Non sfoderabile.

Chair with or without arms with frame in natural beech, Canaletto walnut, wenghè, matt white or black stained beech. Cover in fabric, synthetic nubuck, micro nubuck, soft leather or synthetic leather as per sample card. The cover is not removable.

Chaise avec ou sans accoudoirs avec structure en hêtre naturel, teinté noyer Canaletto, wenghè, ou laqué blanc ou noir opaque. Revêtement en tissu, synthetic nubuck, micro nubuck, cuir mince ou simili cuir selon échantillons. Le revêtement n'est pas déhoussable.

Silla con o sin brazos con patas en haya natural, teñida nogal Canaletto, wenghè, blanco o negro mate. Revestimiento en tejido, synthetic nubuck, micro nubuck, ecopiel o piel según muestrario. El tapizado no es desenfundable.

Stuhl mit oder ohne Armlehne in Buche natur, gebeizt Nussbaum Canaletto, wenghè, matt weiß oder schwarz. Bezug in Stoff, synthetic nubuck, micro nubuck, Kunstleder oder Softleder laut Musterkarte. Nicht abziehbar.

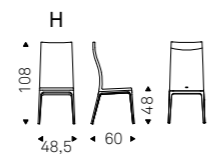
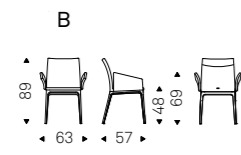
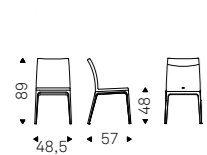



ARCADIA B chair in soft leather 945 Safari and Canaletto walnut frame



ARCADIA chairs in soft leather 993 Artico and Canaletto walnut frame - RIVER table with graphite base and Canaletto walnut top - KAYAK sideboard glossy moka - ZEPPELIN S2 lamp



ARCADIA chair in soft leather 971 Bianco and FNC frame - ARCADIA H chair in soft leather 942 Fango and Canaletto walnut frame - OSCAR coat hanger Canaletto walnut



ARCADIA H chair in soft leather 953 Ardesia and Canaletto walnut frame

ARCADIA COUTURE
Design **Paolo Cattelan**

Sedia con struttura in faggio naturale, tinto noce Canaletto, wenghè, bianco o nero opaco. Rivestimento in ecopelle o pelle come da campionario. Retro schienale trapuntato. Non sfoderabile.

Chair with frame in natural beech, Canaletto walnut, wenghè, matt white or black stained beech. Cover in synthetic leather or soft leather as per sample card. Quilted seatback cover. The cover is not removable.

Chaise avec structure en hêtre naturel, teinté noyer Canaletto, wenghè, ou laqué blanc ou noir opaque. Revêtement en simili cuir ou cuir mince selon échantillons. Dos de siège matelassé. Le revêtement n'est pas déhoussable.

Silla con patas en haya natural, teñida nogal Canaletto, wenghè, blanco o negro mate. Revestimiento en ecopiel o piel según muestrario. Respaldo acolchado. El tapizado no es desenfundable.

Stuhl mit Gestell aus Buche natur, gebeizt Nussbaum Canaletto, wenghè, matt weiß oder schwarz. Bezug aus Kunstleder oder Softleder laut Musterkarte. Rückseite gesteppt. Nicht abziehbar.

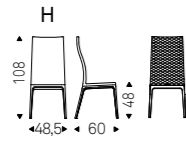
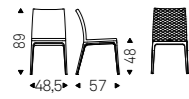

ARCADIA COUTURE chairs in soft leather 952 Smoke and wenghè frame.



ARCADIA COUTURE H chair in soft leather 948 Lino and wenghé frame

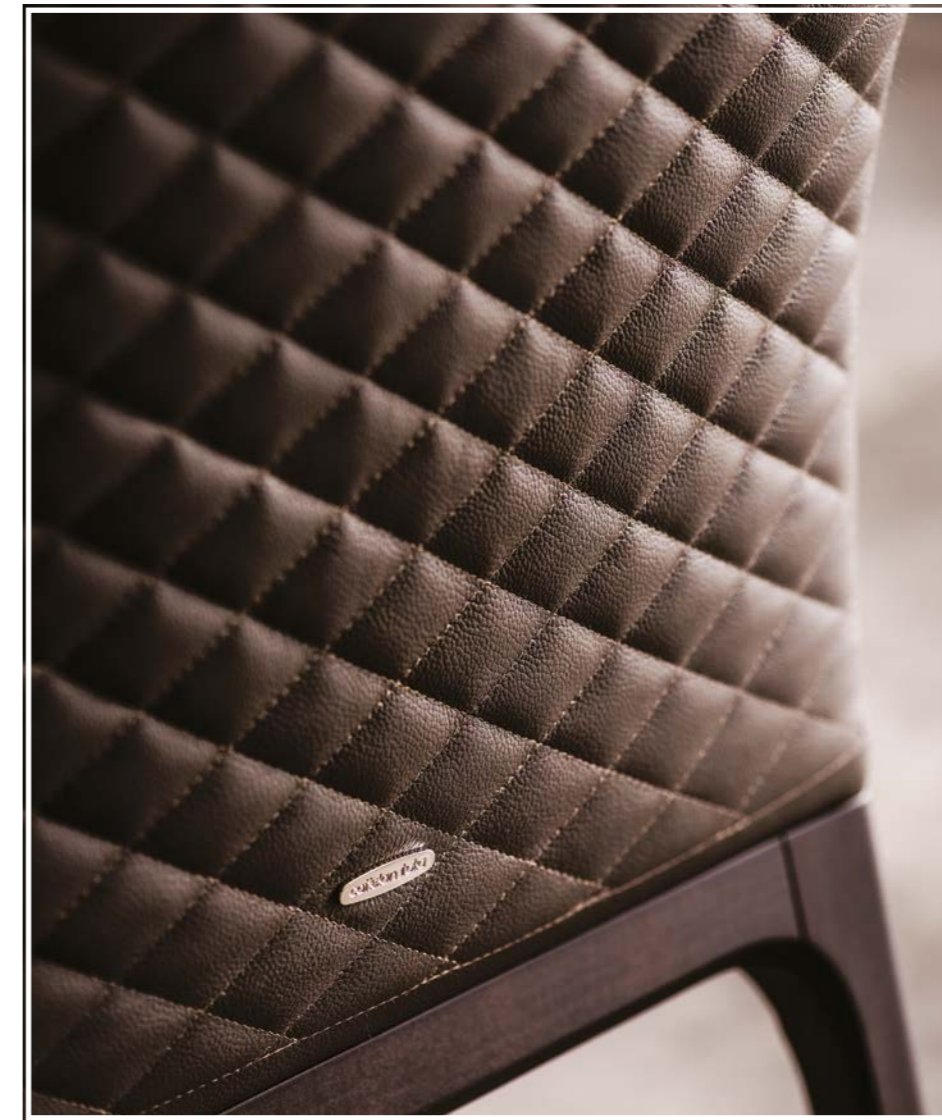

NORMA

Design **Paolo Cattelan**

Sedia imbottita con struttura in acciaio interamente rivestita in ecopelle, synthetic nubuck, micro nubuck o pelle come da campionario. Non sfoderabile.

Upholstered chair with steel frame and covered in synthetic leather, synthetic nubuck, micro nubuck or soft leather as per sample card. The cover is not removable.

Chaise avec structure en acier, rembourrée et complètement revêtue en simili cuir, synthetic nubuck, micro nubuck ou cuir mince selon échantillons. Le revêtement n'est pas déhoussable.

Silla con estructura en acero tapizada y completamente revestida en ecopiel, synthetic nubuck, micro nubuck o piel según muestrario. El tapizado no es desenfundable.

Stuhl mit gepolstertem Stahlgestell mit Bezug aus Kunstleder, synthetic Nubuck, micro Nubuck oder Softleder laut Musterkarte. Nicht abziehbar.

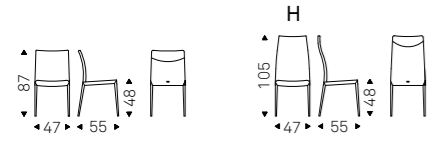

NORMA chairs in soft leather 973 Nero



NORMA chairs in soft leather 948 Lino



NORMA H chairs in soft leather 983 Argilla



NORMA COUTURE

Design **Paolo Cattelan**

Sedia imbottita con struttura in acciaio interamente rivestita in ecopelle, synthetic nubuck o pelle come da campionario. Retro schienale trapuntato. Non sfoderabile.

Upholstered chair with steel frame and covered in synthetic leather, synthetic nubuck or soft leather as per sample card. Quilted seatback cover. The cover is not removable.

Chaise avec structure en acier, rembourrée et complètement revêtue en simili cuir, synthetic nubuck ou cuir mince selon échantillons. Dos de siège matelassé. Le revêtement n'est pas déhoussable.

Silla con estructura en acero tapizada y completamente revestida en ecopiel, synthetic nubuck o piel según muestrario. Respaldo exterior acolchado. El tapizado no es desenfundable.

Stuhl mit gepolstertem Stahlgestell mit Bezug aus Kunstleder, synthetic Nubuck oder Softleder laut Musterkarte. Rückseite gesteppt. Nicht abziehbar.

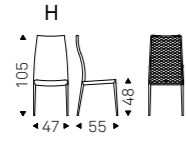
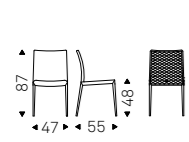

NORMA COUTURE chair in soft leather 953 Ardesia



NORMA COUTURE H chairs in soft leather 947 Oyster - ROLL ROUND table with black base and fumé top - CLOUD lamps - TIFFANY sideboard in soft leather 956 Atlantico



NORMA COUTURE in soft leather 980 Ottanio



NORMA COUTURE H chairs in soft leather 953 Ardesia - SKORPIO KERAMIK table with titanium base and glossy Golden Calacatta ceramic top

DUMBO

Design Archirivolto

Sedia con struttura in frassino tinto noce Canaletto, frassino tinto rovere bruciato, frassino laccato poro aperto bianco o nero opaco. Seduta e schienale rivestiti in ecopelle, synthetic nubuck o pelle come da campionario.

Chair with frame in Canaletto walnut stained ashwood, burned oak stained ashwood or open pore matt white or black ashwood. Seat and back upholstered in synthetic leather, synthetic nubuck or soft leather as per sample card.

Chaise avec structure frêne teinté noyer Canaletto, rouvre brulé ou laqué blanc ou noir opaque pore ouvert. Assise et dossier revêtus en simili cuir, synthetic nubuck ou cuir mince selon échantillons.

Silla con estructura en fresno barnizado nogal Canaletto, roble ahumado, fresno barnizado blanco o negro mate a poro abierto. Asiento y respaldo tapizados en ecopiel, synthetic nubuck o piel según muestrario.

Stuhl mit Gestell aus Esche gebeizt Nussbaum Canaletto, "verbrannte Eiche", oder offenporig lackiert in den Farben weiß oder schwarz matt. Sitz und Rücken mit Kunstleder-, synthetic Nubuck- oder Softlederbezug, laut Musterkarte.

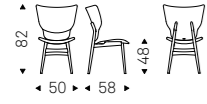

DUMBO in soft leather 980 Ottanio and Canaletto walnut frame



DUMBO chair in soft leather 948 Lino and matt black frame - KLIRR table - MUMBAI rug - EMERALD MAGNUM mirror



DUMBO chair in soft leather 973 Nero and matt black frame



DUMBO in soft leather 980 Ottanio and Canaletto walnut frame

INDY**Design Archirivolto**

Poltroncina in poliuretano morbido con varie basi. Base fissa o girevole in acciaio verniciato trasparente, goffrato titanio, graphite, bianco, nero o in legno faggio naturale, faggio tinto noce Canaletto o rovere bruciato o a 5 razze in alluminio lucido o alluminio verniciato nero opaco con ruote. Seduta in poliuretano monocoloro disponibile nei colori bianco, lino, fango, petrolio o antracite o bicolore retro petrolio e fronte fango. Per forniture superiori a 50 pz disponibili altri colori. Scocca ignifuga 1 IM - CRIB5.

Soft polyurethane armchair with different bases. Fix or swivelling base in transparent, titanium, graphite, white or black embossed lacquered steel or in natural beech, Canaletto walnut or burnt oak stained beech, or with 5 spokes in polished aluminum, or with wheels in black painted aluminum. Seat and back in monochrome polyurethane available in white, lino, fango, petrolio or antracite colors, or two-tone polyurethane back petrolio and front fango. For supplies of more than 50 pieces are available other colors. Fireproof seat 1 IM - CRIB5.

Petit fauteuil en polyuréthane mou avec différentes bases. Base fixe ou pivotant en acier laqué transparent, gaufré titane, graphite, blanc ou noir ou en hêtre naturel, hêtre teinté noyer Canaletto ou rouvre brûlé ou à 5 rayons en aluminium brillant ou aluminium laqué noir opaque avec roues. Assise et dossier en polyuréthane monochrome disponible dans les couleurs blanc, lin, boue, pétrole ou anthracite ou bicolore avec dos en pétrole et front en boue. Disponible en plusieurs couleurs pour ordres supérieurs à 50 pièces. Cocque ignifuge 1IM-CRIB5.

Butaca en poliuretano blando con distintas bases. Base fija o giratoria en acero barnizado transparente, gofrado titanio, graphite, blanco, negro o en haya natural, haya pintada nogal Canaletto o roble ahumado o base con 5 radios con ruedas en aluminio brillo o aluminio barnizado negro mate. Asiento en poliuretano monocromo disponible en blanco, lino, fango, petróleo u antracita o bicolor petróleo por detrás y fango de frente. Para pedidos con más de 50 piezas disponibles otros colores. Asiento ignífugo 1 IM - CRIB5.

Stuhl in Weich-Polyurethan mit verschiedenen Basis. Fest oder drehbarer mit Gestell in Edelstahl lackiert transparent, gaufriert Titan, graphit, weiß, schwarz oder in Buche natur, Buche gebeizt Nussbaum Canaletto oder verbrannte Eiche oder mit 5 Sterne-Sockel mit Rollen in Aluminium glänzend oder Aluminium schwarz lackiert. Sitz in Polyurethan unifarbig weiß, Lino, Fango, Petrolio oder Anthracite oder zweifarbig: Petrolio und Fango. Für Bestellungen ab 50 Stücke sind auch andere Farben lieferbar. Hülle feuerfest 1 IM - CRIB5.

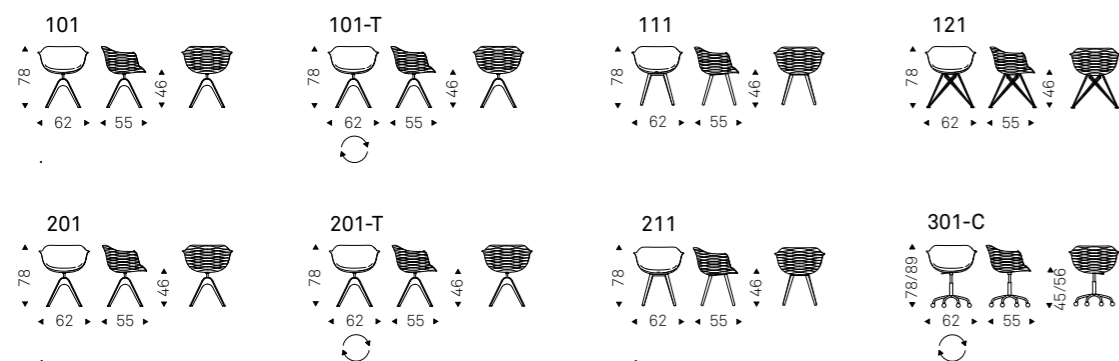

INDY 101 chair in polyurethane P04 Petrolio/ P03 Fango and graphite base



INDY 111 chair in polyurethane P05 Antracite and graphite base - EUROPA KERAMIK sideboard Alabastro



INDY 201 chair in polyurethane P03 Fango and Canaletto walnut base - ARSENAL bookcase



211



111



201
201-T ◯



101
101-T ◯



121



301-C ◯



INDY 211 in polyurethane P04 Petrolio / P03 Fango and burned oak base - INDY 111 in polyurethane P05 Antracite and Nero base
 INDY 111 in polyurethane P01 Bianco and Bianco base

INDY 201 in polyurethane P03 Fango and Canaletto walnut base - INDY 101 in polyurethane P04 Petrolio and graphite base
 INDY 121 in polyurethane P01 Bianco and transparent base - WALLY bookcases Ottanio

RITA

Design Archirivolto

Sedia con struttura in acciaio verniciato bianco, nero, graphite opaco o gofrato titanio. Rivestimento in tessuto, synthetic nubuck, micro nubuck, soft leather or pelle come da campionario. Non sfoderabile.

Chair with frame in white, black, graphite painted steel or titanium embossed steel. Cover in fabric, synthetic nubuck, micro nubuck, soft leather or synthetic leather as per sample card. The cover is not removable.

Chaise avec structure en acier laqué blanc, noir, graphite opaque ou en acier gaufré titane. Revêtement en tissu, synthetic nubuck, micro nubuck, cuir mince ou simili cuir selon échantillons. Le revêtement n'est pas déhoussable.

Silla con estructura en acero barnizado blanco, negro, graphite mate o barnizado gofrado titanio. Tapizada en tejido, synthetic nubuck, micro nubuck, piel o ecopiel según muestrario. El tapizado no es desenfundable.

Stuhl mit Gestell aus Stahl weiß, schwarz, graphite lackiert oder lackiert Titan gaufriert. Bezug aus Stoff, synthetic nubuck, micro nubuck, Softleder oder Kunstleder laut Musterkarte. Nicht abziehbar.

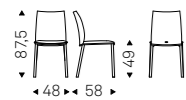



RITA chair with graphite frame and seat B302 fabric



RITA chair with graphite frame, and seat in soft leather 948 Lino



GINGER chairs in soft leather 956 Atlantico - ROLL WOOD table with titanium base, burned oak top - RADJA rug

GINGER

Design Archirivolto

Sedia con struttura in acciaio rivestita in tessuto, synthetic nubuck, micro nubuck, ecopelle o pelle come da campionario. Non sfoderabile.

Chair with steel frame upholstered in fabric, synthetic nubuck, micro nubuck, synthetic leather or soft leather as per sample card. The cover is not removable.

Chaise avec structure en acier. Revêtement en tissu, synthetic nubuck, micro nubuck, simili cuir ou cuir mince selon échantillons. Le revêtement n'est pas déhoussable.

Silla con estructura en acero tapizada en tejido, synthetic nubuck, micro nubuck, ecopiel o piel según muestrario. El tapizado no es desfundable.

Stuhl mit Stahlgestell mit Stoff-, synthetic nubuck-, micro nubuck-, Kunstleder- oder Softlederbezug, laut Musterkarte. Nicht abziehbar.



GINGER chair in soft leather 953 Ardesia



GINGER chairs in soft leather 953 Ardesia - SPYDER WOOD table with black base, burned oak top - HORIZON sideboard



BETTY chair in soft leather 980 Ottanio and black base - ROLL ROUND table with black base, fumè top - ROYALTON sideboard titanium - DIAMOND mirror

BETTY

Design **Yasuhiro Shito**

Sedia imbottita con struttura in acciaio e rivestimento in tessuto, synthetic nubuck, micro nubuck, pelle o ecopelle come da campionario. Base in acciaio verniciato bianco, nero, graphite opaco, cromato o gofrato titanio. Il rivestimento non è sfoderabile.

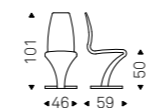

Upholstered chair with steel frame and cover in fabric, synthetic nubuck, micro nubuck, soft leather or synthetic leather as per sample card. Matt white, black, graphite, chromed or titanium embossed laquered steel base. The cover is not removable.

Chaise rembourée avec structure en acier et revêtement en tissu, synthetic nubuck, micro nubuck, cuir mince ou simili cuir selon échantillons. Base en acier laqué blanc, noir, graphite opaque, chromé ou gaufré titane. Le revêtement n'est pas déhoussable.

Silla embutida con estructura en acero y revestimiento en tejido, synthetic nubuck, micro nubuck, piel o ecopiel según muestrario. Base en acero barnizado blanco, negro, graphite mate, cromado o gofrado titanio. El revestimiento no se puede desenfundar.

Gepolsterter Stuhl mit Edelstahlgestell und Bezug aus Stoff, synthetic nubuck, micro nubuck, Softleder oder Kunstleder in den Farben laut Musterkarte. Basis aus Stahl matt weiss, matt schwarz, oder lackiert Titan gaufriert. Bezug ist nicht aufziehbar.



BETTY chair in soft leather 971 Bianco and chrome base

PIUMA EDITION

Design **Studio Kronos**

Sedia superleggera con o senza braccioli e struttura in acciaio, rivestita in cuoio come da campionario. Cuciture standard.

Ultralight chair with or without arms and steel frame covered in leather as per sample card. Standard stitchings.

Chaise extralégère avec ou sans accoudoirs et structure en acier revêtue en cuir selon échantillons. Coutures standard.

Silla superligera con o sin brazos y estructura en acero tapizada en cuero según muestrario. Cosido estándar.

Superleichter Stuhl mit oder ohne Armlehnen. Stahlgestell. Bezug aus Kernleder laut Musterkarte. Nähte standard.

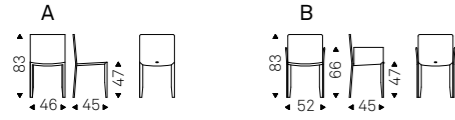

PIUMA EDITION B in leather 49 Cenere



PIUMA EDITION A in leather 73 Nero - MUMBAI rug



FLAMINIA A chairs in soft leather 952 Smoke and black frame

FLAMINIA**Design Paolo Cattelan**

Sedia girevole con o senza braccioli con struttura in acciaio verniciato trasparente, gofrato bianco, nero o graphite. Seduta e schienale rivestiti in tessuto, synthetic nubuck, micro nubuck, ecopelle o pelle come da campionario. Non sfoderabile.

Swivelling chair with or without arms with transparent varnished steel, white, black or graphite embossed lacquered steel frame. Seat and back upholstered in fabric, synthetic nubuck, micro nubuck, synthetic leather or soft leather as per sample card. The cover is not removable.

Chaise pivotante avec ou sans accoudoirs, avec structure en acier laqué transparent, gaufré blanc, noir ou graphite. Assise et dossier revêtus en tissu, synthetic nubuck, micro nubuck, simili cuir ou cuir mince selon échantillons. Le revêtement n'est pas déhoussable.

Silla giratoria con o sin brazos con estructura en acero barnizado transparente, gofrado blanco, negro o graphite. Asiento y respaldo tapizados en tejido, synthetic nubuck, micro nubuck, ecopiel o piel según muestrario. El tapizado no es desenfundable.

Drehstuhl mit oder ohne Armlehnen, Gestell in Stahl lackiert transparent, lackiert weiß, schwarz oder graphite gaufriert. Sitz und Rücken bezogen mit Stoff-, synthetic nubuck-, micro nubuck-, Kunstleder- oder Softlederbezug, laut Musterkarte. Nicht abziehbar.

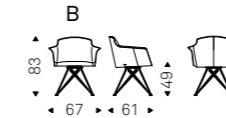
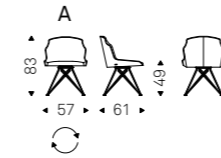

FLAMINIA B chair in soft leather 946 Marrone and black frame

JANET

Design **Paolo Cattelan**

Sedia cantilever con struttura in acciaio cromato. Rivestimento in tessuto, synthetic nubuck, micro nubuck, ecopelle o pelle come da campionario. Non sfoderabile.

Chair with cantilever frame in chromed steel. Upholstered seat in fabric, synthetic nubuck, micro nubuck, synthetic leather or soft leather as per sample card. The cover is not removable.

Chaise cantilever avec structure en acier chromé. Revêtement en tissu, synthetic nubuck, micro nubuck, simili cuir ou cuir mince selon échantillons. Le revêtement n'est pas déhoussable.

Silla con estructura en acero cromado. Revestimiento embutido tapizado en tejido, synthetic nubuck, micro nubuck, ecopiel o piel según muestrario. El tapizado no es desenfundable.

Freischwinger-Stuhl mit Gestell in verchromtem Stahl. Gepolsterte Sitz mit Stoff-, synthetic nubuck-, micro nubuck-, Kunstleder- oder Softlederbezug laut Musterkarte. Nicht abziehbar.

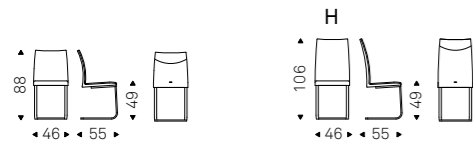

JANET chair in soft leather 948 Lino and chromed steel frame



JANET H chair in soft leather 952 Smoke and chromed steel frame



JANET chair in soft leather 948 Lino and chromed steel frame

ISABEL SGABELLO

Design **Paolo Cattelan**

Sgabello con struttura in acciaio. Cuscini imbottiti e rivestimento in ecopelle, tessuto, synthetic nubuck, micro nubuck, Leathertex o pelle come da campionario. Non sfoderabile.

Stool with steel frame. Cushions and covering in synthetic leather, fabric, synthetic nubuck, micro nubuck, Leathertex or soft leather as per sample card. The cover is not removable.

Tabouret avec structure en acier. Coussins et revêtement en simili cuir, tissu, synthetic nubuck, micro nubuck, Leathertex ou cuir mince selon échantillons. Le revêtement n'est pas déhoussable.

Taburete con estructura en acero. Cojines tapizados e revestimiento en ecopiel, tejido, synthetic nubuck, micro nubuck, Leathertex o piel según muestrario. El tapizado no es desenfundable.

Barhocker mit Stahlgestell. Bezug aus Kunstleder, Stoff, synthetic Nubuck, micro Nubuck, Leathertex oder Softleder laut Musterkarten. Nicht abziehbar.

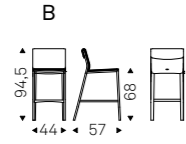
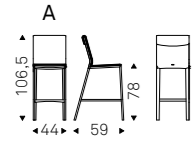

ISABEL SGABELLO A in soft leather 956 Atlantico



ISABEL SGABELLO A in soft leather 951 Castoro - JANEIRO MAGNUM mirror with Canaletto walnut frame

ARCADIA SGABELLO

Design **Paolo Cattelan**

Sgabello con struttura in faggio naturale, tinto noce Canaletto, wenghè, bianco o nero opaco. Rivestimento in tessuto, synthetic nubuck, micro nubuck, ecopelle o pelle come da campionario. Non sfoderabile.

Stool with frame in natural beech, Canaletto walnut, wenghè, matt white or black stained beech. Cover in fabric, synthetic nubuck, micro nubuck, soft leather or synthetic leather as per sample card. The cover is not removable.

Tabouret avec structure en hêtre naturel, teinté noyer Canaletto, wenghè, ou laqué blanc ou noir opaque. Revêtement en tissu, synthetic nubuck, micro nubuck, simili cuir ou cuir mince selon échantillons. Le revêtement n'est pas déhoussable.

Taburete con patas en haya natural, teñida nogal Canaletto, wenghè, blanco o negro mate. Revestimiento en tejido, synthetic nubuck, micro nubuck, ecopiel o piel según muestrario. El tapizado no es desenfundable.

Barhocker mit gestell in Buche natur, gebeizt Nussbaum Canaletto, wenghè, matt weiß oder schwarz. Bezug in Stoff, synthetic nubuck, micro nubuck, Kunstleder oder Softleder laut Musterkarte. Nicht abziehbar.

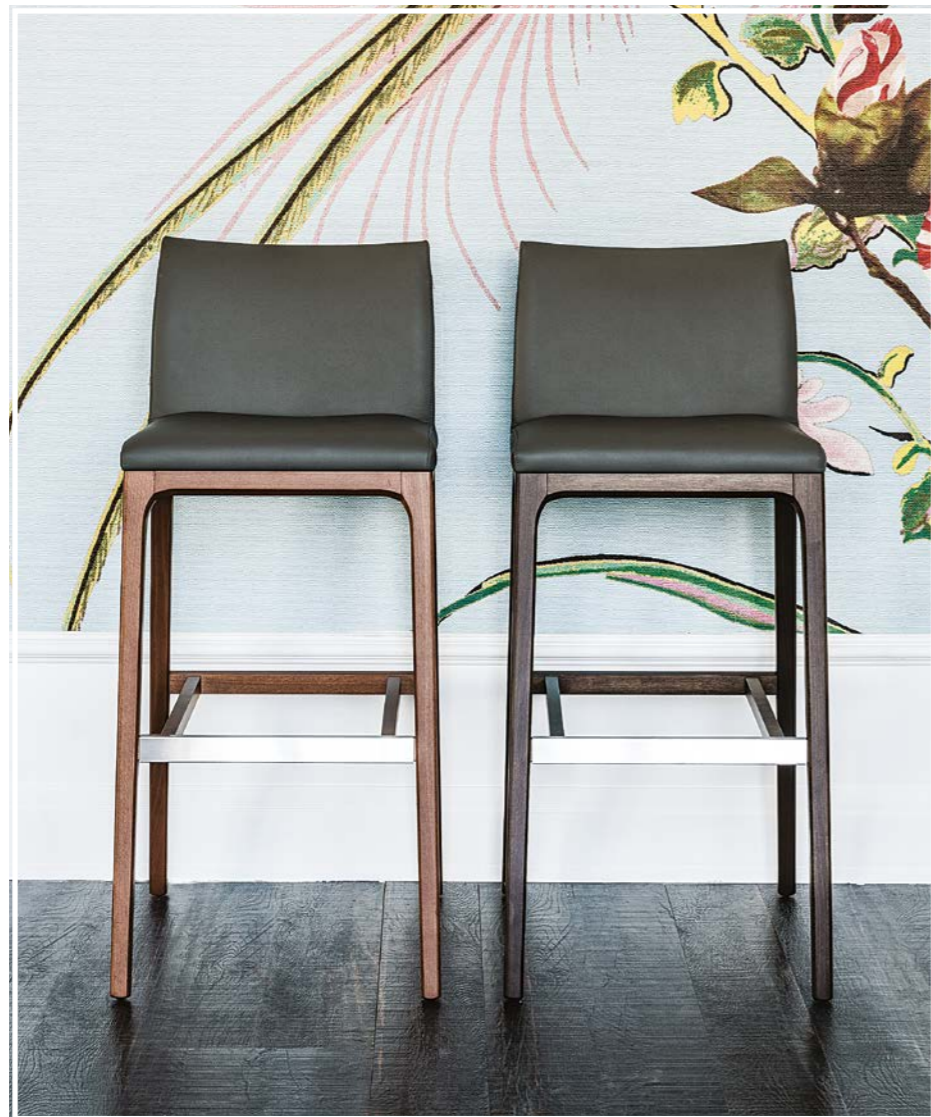
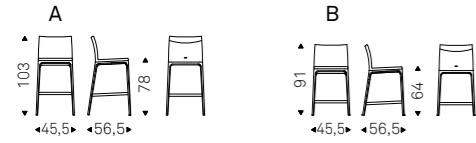



ARCADIA COUTURE SGABELLO A in soft leather 948 Lino and wenghè frame

ARCADIA COUTURE SGABELLO

Design **Paolo Cattelan**

Sgabello con struttura in faggio naturale, tinto noce Canaletto, wenghè, bianco o nero opaco. Rivestimento in ecopelle o pelle come da campionario. Retro schienale trapuntato. Non sfoderabile.

Stool with frame in natural beech, Canaletto walnut, wenghè, matt white or black stained beech. Cover in synthetic leather or soft leather as per sample card. Quilted seatback cover. The cover is not removable.

Tabouret avec structure en hêtre naturel, teinté noyer Canaletto, wenghè, ou laqué blanc ou noir opaque. Revêtement en simili cuir ou cuir mince selon échantillons. Dos de siège matelassé. Le revêtement n'est pas déhoussable.

Taburete con patas en haya natural, teñida nogal Canaletto, wenghè, blanco o negro mate. Revestimiento en ecopiel o piel según muestrario. Respaldo exterior acolchado. El tapizado no es desenfundable.

Barhocker mit Gestell aus Buche natur, gebeizt Nussbaum Canaletto, wenghè, matt weiß oder schwarz. Bezug aus Kunstleder oder Softleder laut Musterkarte. Rückseite gesteppt. Nicht abziehbar.

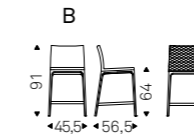
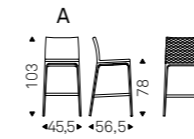

ARCADIA COUTURE SGABELLO B in soft leather 973 Nero and Canaletto walnut frame

TOTO X**Design Paolo Cattelan**

Sgabello ultraleggero regolabile in altezza e girevole con base a 4 razze in alluminio lucido, colonna, poggiatesta e pistone a gas in acciaio cromato o base, colonna, poggiatesta verniciati gofrato nero o titanio e pistone a gas in acciaio cromato. Scocca rivestita in cuoio come da campionario.

Swiveling ultralight stool, adjustable in height with 4 spokes base in polished aluminium and column, footrest and gas piston in chromed steel or with base plate, column, and footrest in black or titanium embossed lacquered steel and gas piston in chromed steel. Frame covered in leather as per sample card.

Tabouret ultraléger réglable en hauteur et pivotant. Base avec 4 rayons en aluminium poli, colonne, repose-pieds et piston en acier chromé ou base, colonne et repose-pieds gaufrés noir ou titane et piston en acier chromé. Assise en cuir selon échantillons.

Taburete ultraligero regulable en altura y giratorio con base con 4 radios en aluminio brillo, columna, reposapiés y pistón de gas en acero cromado o base, columna, reposapiés barnizados gofrado negro o titanio y pistón de gas en acero cromado. Respaldo tapizado en cuero según muestrario.

Superleicht Höhenverstellbarer und drehbarer Barhocker mit 4-Sterne-Sockel aus poliertem Aluminium, Säule, Fußraste und Gas Druckfeder aus verchromtem Stahl, oder Basis, Säule, Fußraste in Stahl lackiert gaufriert schwarz oder Titan und Gas Druckfeder aus verchromten Stahl. Sitzbezug in Kernleder laut Musterkarte.

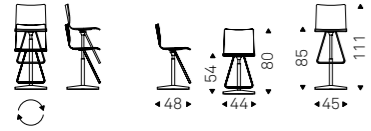

TOTO X with titanium base and seat in leather 47 Oyster



TOTO X with black base and in seat leather 42 Fango - NIDO KERAMIK BISTROT table black base, Ardesia ceramic top A - EMERALD MAGNUM mirror fumé



FLAMINIO B75 with black frame and soft leather 946 Marrone seat

FLAMINIO**Design Paolo Cattelan**

Sgabello girevole con o senza braccioli con struttura in acciaio verniciato trasparente, gofrato bianco, nero o graphite. Seduta e schienale rivestiti in tessuto, synthetic nubuck, micro nubuck, ecopelle o pelle come da campionario. Non sfoderabile.

Swivelling stool with or without arms with transparent varnished steel, white, black or graphite embossed lacquered steel frame. Seat and back upholstered in fabric, synthetic nubuck, micro nubuck, synthetic leather or soft leather as per sample card. The cover is not removable.

Tabouret pivotant avec ou sans accoudoirs, avec structure en acier laqué transparent, gaufré blanc, noir ou graphite. Assise et dossier revêtus en tissu, synthetic nubuck, micro nubuck, simili cuir ou cuir mince selon échantillons. Le revêtement n'est pas déhoussable.

Taburete giratorio con o sin brazos con estructura en acero barnizado transparente, gofrado blanco, negro o graphite. Asiento y respaldo tapizados en tejido, synthetic nubuck, micro nubuck, ecopiel o piel según muestrario. El tapizado no es desenfundable.

Drehbarhocker mit oder ohne Armlehnen, Gestell in Stahl lackiert transparent, lackiert weiß, schwarz oder graphite gaufriert. Sitz und Rücken bezogen mit Stoff-, synthetic nubuck-, micro nubuck-, Kunstleder- oder Softlederbezug, laut Musterkarte. Nicht abziehbar.

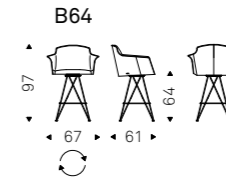
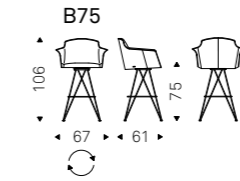
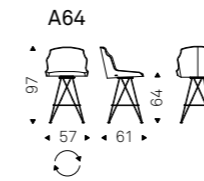
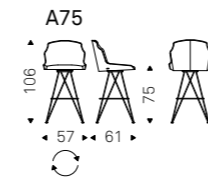

FLAMINIO A64 with graphite frame and soft leather 952 Smoke seat

KAYAK**Design Andrea Lucatello**

Madia contenitore a due o tre ante in legno laccato bianco lucido, nero lucido, moka lucido, rosso lucido, graphite opaco o titanio. Piedini in acciaio inox lucido, verniciati bianco o graphite opaco. Ripiani interni in cristallo trasparente. Cassetto interno nella versione a 3 ante.

Sideboard 2 or 3 doors in polished lacquered glossy black, glossy white, glossy moka, glossy red, matt graphite or titanium. Polished stainless steel feet, matt white or graphite varnished. Internal clear glass shelves. Internal drawer in the 3 doors version.

Bahut 2 ou 3 portes bois laqué blanc brillant, noir brillant, moka brillant, rouge brillant, graphite opaque ou titane. Pieds en acier inox brillant, laqué blanc ou graphite opaque. Étagère en verre clair, tiroir intérieur dans la version 3 portes.

Aparador de 2 o 3 puertas en madera lacada blanco brillo, negro brillo, moka brillo, rojo brillo, graphite mate o titanio. Patas en acero inox brillo, barnizado blanco mate o graphite mate. Estantes interiores en cristal transparente. Cajón interior en la versión 3 puertas.

Anrichte mit zwei oder drei Türen in Holz glänzend lackiert in weiß, schwarz, moka, rot, matt lackiert in graphit oder lackiert Titan. Füße aus glänzendem Edelstahl, oder matt weiß oder graphit lackiert. Innenböden in Klarglas. Version drei Türen mit Schublade in der Mitte ausgestattet.

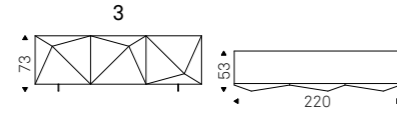
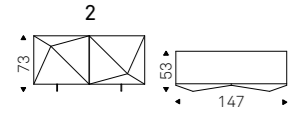

KAYAK 2 sideboard in titanium finish



KAYAK 3 sideboard in titanium finish – REGAL mirror in fumé finish

ABSOLUT

Design Paolo Cattelan

Madia contenitore a due o tre ante in legno goffrato bianco, nero o graphite con base in acciaio goffrato in tinta. Ante rivestite in pelle trapuntata nei colori come da campionario con profili in alluminio verniciato titanio goffrato. Ripiani interni in cristallo trasparente. Optional: 1 cassetto interno nel vano centrale della versione a 3 ante. Optional: top in cristallo acidato verniciato in tinta con la struttura.

Sideboard 2 or 3 doors in lacquered white, black or graphite embossed wood. Embossed steel base in the same color. Doors covered and quilted in soft leather as per sample card with embossed titanium aluminum profiles. Internal clear glass shelves. Optional: 1 internal drawer in the central door of 3 version. Optional: top in frosted glass painted in the same color of the structure.

Bahut 2 ou 3 portes en bois gaufré blanc, noir ou graphite et pieds en acier gaufré du même couleur. Portes revêtues matelassées en cuir mince selon échantillons avec profils en aluminium gaufré titane. Étagères en verre clair. Optionnel: 1 tiroir intérieur sur la porte centrale de la version 3 portes. Optionnel: plateau en verre dépoli de la même couleur de la structure.

Aparador de 2 o 3 puertas en madera gofrado blanco, negro o graphite con patas en acero gofrado a juego. Puertas revestidas y acolchadas en piel según muestrario y perfil en aluminio gofrado titanio. Estantes interiores en cristal transparente. Opcional: 1 cajón interior en la puerta central en la versión 3 puertas. Opcional: sobre en cristal barnizado en el mismo color de la estructura.

Anrichte mit zwei oder drei Türen in Holz gaufriert weiß, schwarz oder graphit mit Füße aus Stahl gleichfarbig gaufriert. Türen bezogen mit Softleder gesteppt laut Musterkarte mit titan gaufriert aluminium Rahmen. Innenböden aus Klarglas. Optional: 1 Innenschublade in die Mitteltür in der 3-Türen Version verfügbar. Optional: Platte aus Glas geätzt in den gleichen Farbe des Gestell.

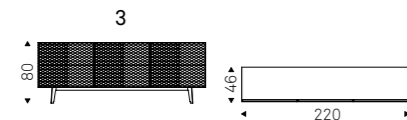
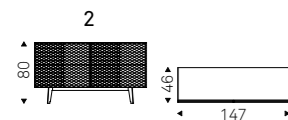

ABSOLUT 2 sideboard with doors in soft leather 952 Smoke and frame in graphite finish



ABSOLUT 3 sideboard with doors in soft leather 971 Bianco and frame in white finish - MUMBAI rug - SABLIER lamps in mixed glass



ABSOLUT 3 sideboard with doors in soft leather 974 Capri and frame in graphite finish - NIDO coffee table with black base and black embossed steel top
 RADJA rugs - BYBLOSS lamp in black finish - HAWAII B + E mirror in fumé glass



ABSOLUT 3 sideboard in soft leather 942 Fango - RADJA rugs

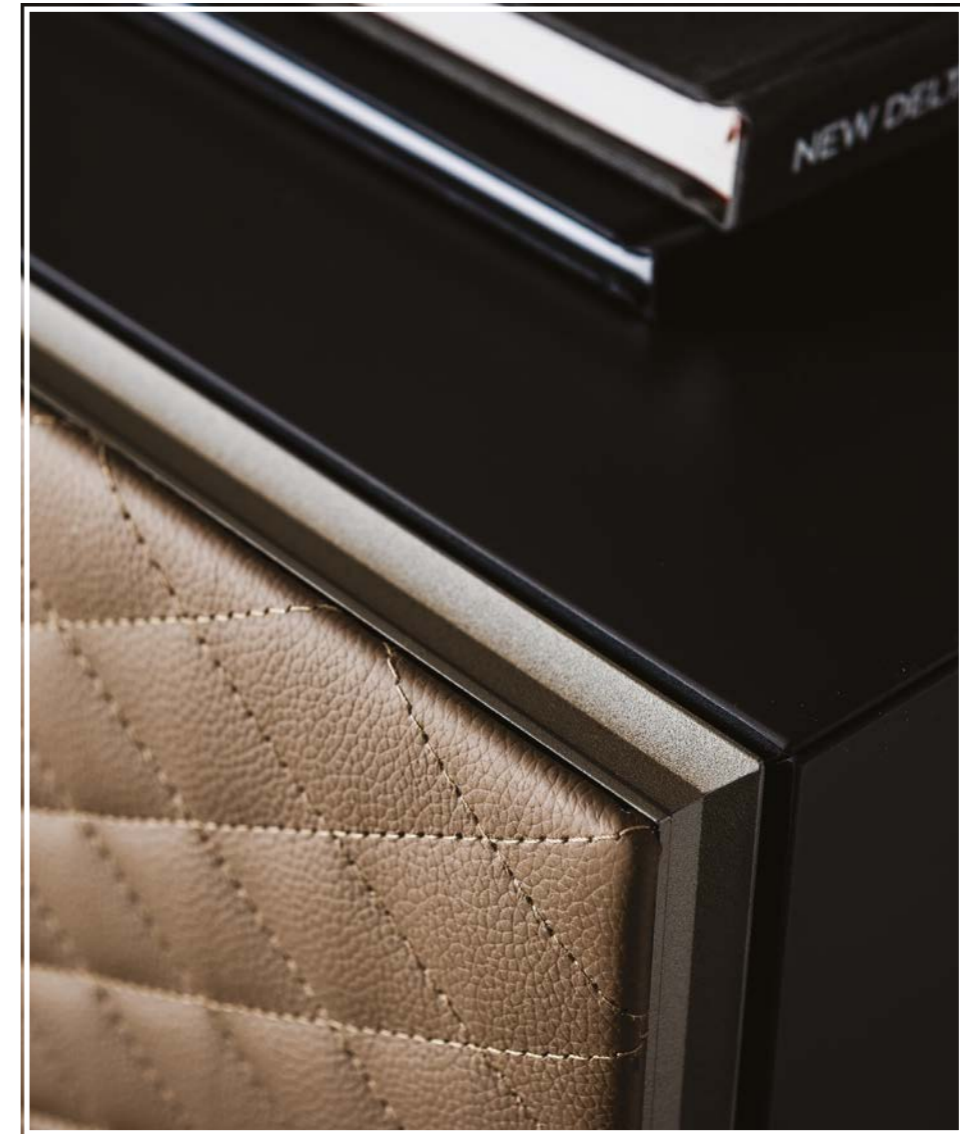

METROPOL

Design **Paolo Cattelan**

Madia contenitore in legno gofrato bianco, nero o graphite con base in acciaio gofrato in tinta. Ante in ceramica Marmi nei colori Calacatta, Alabastro, Ardesia, Golden Calacatta opaco, Golden Calacatta lucido, Portoro opaco o Portoro lucido con profili in alluminio anodizzato titanio. Ripiani interni in cristallo trasparente. Optional: 1 cassetto interno nel vano centrale della versione a 3 ante. Optional: top in cristallo acidato verniciato in tinta con la struttura.

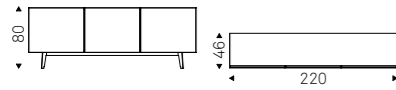

Sideboard in lacquered white, black or graphite embossed wood. Embossed steel base in the same color. Doors in ceramic Marmi Calacatta, Alabastro, Ardesia, matt Golden Calacatta, glossy Golden Calacatta, matt Portoro or glossy Portoro with titanium aluminum anodized profiles. Internal clear glass shelves. Optional: 1 internal drawer in the central door of 3 version. Optional: top in frosted glass painted in the same color of the structure.

Bahut 3 portes en bois gaufré blanc, noir ou graphite et pieds en acier gaufré de la même couleur. Portes en céramique dans les couleurs Marmi Calacatta, Alabastro, Ardesia, Golden Calacatta opaque, Golden Calacatta brillant, Portoro opaque ou Portoro brillant avec profilés en aluminium anodisé titane. Étagères en verre clair. Optionnel: 1 tiroir intérieur sur la porte centrale de la version 3 portes. Optionnel: plateau en verre dépoli de la même couleur de la structure.

Aparador en madera gofrada blanco, negro o graphite con patas en acero gofrado a juego. Puertas en cerámica Marmi en los colores Calacatta, Alabastro, Ardesia, Golden Calacatta mate, Golden Calacatta brillo, Portoro mate o Portoro brillo y perfil en aluminio anodizado titanio. Estantes interiores en cristal transparente. Opcional: 1 cajón interior en la puerta central en la versión 3 puertas. Opcional: sobre en cristal barnizado en el mismo color de la estructura.

Anrichte aus Holz lackiert weiß, schwarz oder graphit gaufriert mit Füße aus Stahl gleichfarbig gaufriert. Türen aus Keramik Marmi Calacatta, Alabastro, Ardesia, matt Golden Calacatta, glänzend Golden Calacatta, matt Portoro oder glänzend Portoro mit titan eloxiert aluminium Rahmen. Innenböden aus Klarglas. Optional: 1 Innenschublade in die Mitteltür in der 3-Türen Version verfügbar. Optional: Platte aus Glas geätzt in den gleichen Farbe des Gestell.





Calacatta ceramic Marmi



Matt Golden Calacatta ceramic Marmi



Glossy Portoro ceramic Marmi



METROPOL sideboard in Ardesia ceramic and graphite frame - AIR coat hangers in black finish - GLENN mirror 120x120 mirrored smoked grey

ROYALTON**Design Philip Jackson**

Madia contenitore in legno e ante in poliuretano laccato bianco, graphite opaco o titanio. Piedi in acciaio inox lucido o verniciati bianco o graphite opaco. Ripiani interni in cristallo trasparente. Optional: 1 cassetto interno nel vano centrale della versione a 3 ante.

Sideboard in matt white, graphite or titanium lacquered wood with polyurethane doors. Polished stainless steel feet or matt white or graphite varnished. Internal shelves in clear glass. Optional: 1 internal drawer in the central door of 3 version.

Bahut en bois et portes en polyuréthane laqué opaque blanc, graphite ou titane. Petit pieds en acier inox brillant ou verni blanc ou graphite opaque. Etagères internes en verre transparent. Optionnel: 1 tiroir intérieur sur la porte centrale de la version 3 portes.

Aparador en madera con puertas en poliuretano lacado blanco, graphite opaco o titanio. Patas en acero inox brillo, barnizado blanco o graphite mate. Estantes interiores en cristal transparente. Opcional: 1 cajón interior en la puerta central en la versión 3 puertas.

Anrichte mit Struktur aus Holz und Türen Polyurethan matt weiß, graphit oder titan lackiert. Füße aus glänzendem Edelstahl oder matt weiß oder graphit lackiert. Innenböden aus Klarglas. Optional: 1 Innenschublade in die Mitteltür in der 3-Türen Version verfügbar.

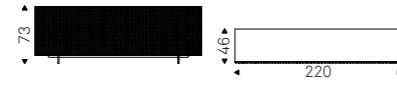
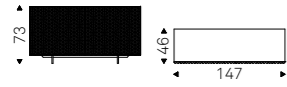

ROYALTON sideboard matt titanium



ROYALTON sideboard matt white - GLENN mirror in mirrored glass

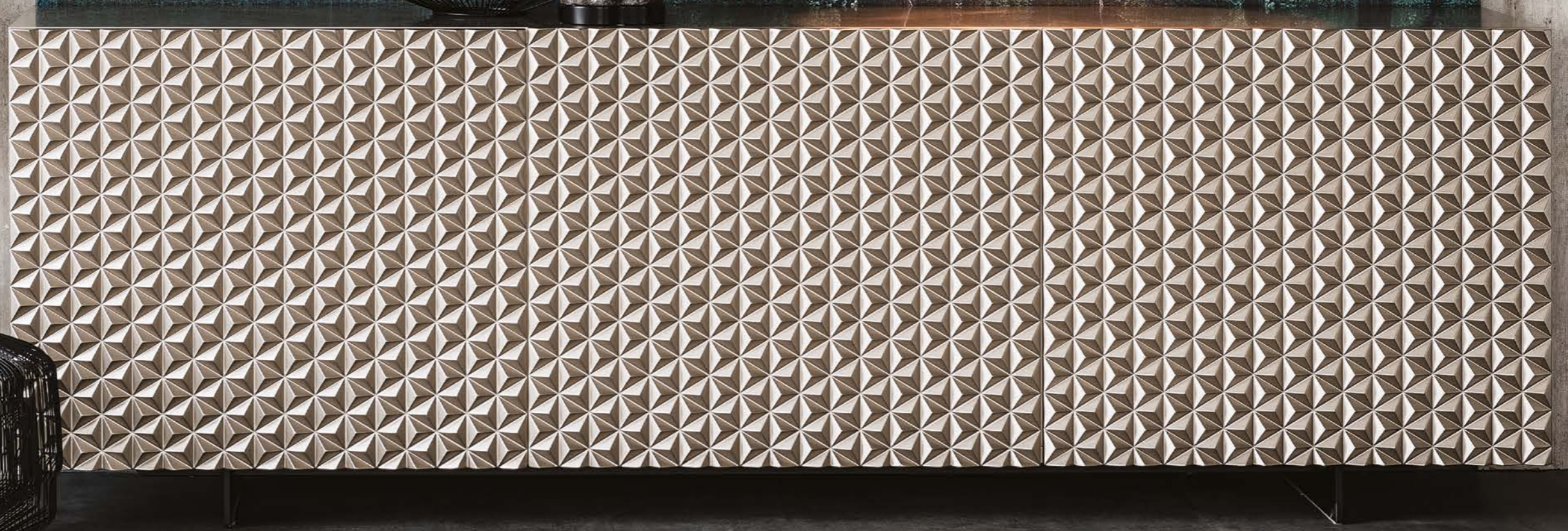

ROYALTON sideboard matt titanium - DUMBO chair in soft leather 973 Nero and black frame - ASIA lamp cobalt blue

TIFFANY**Design Paolo Cattelan**

Madia contenitore in legno gofrato bianco, nero o graphite con base in acciaio gofrato in tinta. Ante rivestite in pelle trapuntata nei colori come da campionario con profili in alluminio verniciato titanio gofrato. Interno parzialmente specchiato e ripiani in cristallo fumé. Optional: kit luce interna a led.

Sideboard in lacquered embossed wood. Embossed steel base in the same color. Doors covered and quilted in soft leather as per sample card with embossed titanium aluminum profiles. Partially mirrored inside and fumé glass shelves. Optional: internal led light kit.

Bahut en bois gaufré blanc, noir ou graphite et pieds en acier gaufré du même couleur. Portes revêtues matelassés en cuir mince selon échantillons avec profilés en aluminium gaufré titane. Interne partiellement miroité et étagères en verre fumé. Optionnel: kit lumière interne à led.

Aparador en madera gofrada blanco, negro o graphite con patas en acero gofrado a juego. Puertas revestidas y acolchada en piel según muestrario y perfil en aluminio gofrado titanio. Interior parcialmente espejado y estantes en cristal fumé. Opcional: kit iluminación interior led.

Anrichte aus Holz lackiert weiß, schwarz oder graphit gaufriert mit Füße aus Stahl gleichfarbig lackiert. Türen bezogen mit gesteppte Softleder laut Musterkarte mit titan gaufriert aluminium Rahmen. Ansatzweise verspiegeltes Innere und Böden aus Glas fumé. Optional: Led Kit für Innenbeleuchtung.

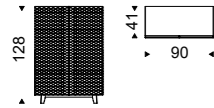

TIFFANY sideboard in soft leather 956 Atlantico



TIFFANY sideboards in soft leather 956 Atlantico - DUMBO chair in soft leather 973 Nero and matt black fr73 frame

PARAMOUNT**Design Andrea Lucatello**

Madia contenitore a due o tre ante in legno laccato moka lucido, bianco lucido, bianco opaco, graphite opaco o titanio. Ante in cristallo bombato specchiato bronzo o fumé con profili in alluminio verniciato titanio gofrato. Piedini in acciaio inox lucido, verniciati bianco o graphite opaco. Ripiani interni in cristallo trasparente. Optional: 1 cassetto interno nel vano centrale della versione a 3 ante. Optional: top in cristallo specchiato in tinta con le ante.

Sideboard 2 or 3 doors lacquered glossy moka, glossy white, matt white, matt graphite or titanium. Doors in smoked grey or bronze convex mirrored glass with embossed titanium aluminium profiles. Polished stainless steel feet, matt white or graphite varnished. Internal clear glass shelves. Optional: 1 internal drawer in the central door of 3 version. Optional: mirrored glass top matching the doors colour.

Bahut 2 ou 3 portes en bois laqué moka brillant, blanc brillant, blanc opaque, graphite opaque ou titane. Portes en verre convexe miroité fumé ou miroité bronze avec profilés en aluminium gaufré titane. Pieds en acier inox brillant, laqués blanc ou graphite opaque. Étagères en verre clair. Optionnel: 1 tiroir intérieur sur la porte centrale de la version 3 portes. Optionnel: plateau en verre miroité de la même couleur des portes.

Aparador de 2 o 3 puertas en madera lacada moka brillo, blanco brillo, blanco mate, graphite mate o titanio. Puertas en cristal convexo reflejado fumé o reflejado bronzo y perfil en aluminio gofrado titanio. Patas en acero inox brillo, barnizado blanco mate o graphite mate. Estantes interiores en cristal transparente. Opcional: 1 cajón interior en la puerta central en la versión 3 puertas. Opcional: sobre en cristal reflejado en el mismo color de las puertas.

Anrichte mit zwei oder drei Türen aus Holz glänzend lackiert moka, weiß, weiß matt, graphit matt oder titan. Türen aus fumé oder bronze verspiegeltem Konvex Glas mit titan gaufriert aluminium Rahmen. Füße aus glänzendem Edelstahl, oder matt weiß oder graphit lackiert. Innenböden aus Klarglas. Optional: 1 Innenschublade in die Mitteltür in der 3-Türen Version verfügbar. Optional: verspiegelte Glasplatte und Türen sind gleichfarbig.

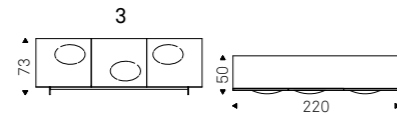
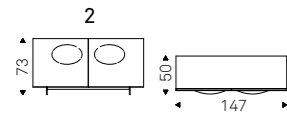

PARAMOUNT sideboard graphite, doors in smoked grey mirrored glass



PARAMOUNT sideboard moka, doors in bronze mirrored glass



PARAMOUNT sideboard graphite, doors in smoked grey mirrored glass

EXPLORER

Design **Paolo Cattelan**

Madia con 2 o 4 ante. Struttura e top verniciati graphite o bianco opaco e ante in noce Canaletto, rovere bruciato, rovere Heritage o struttura, top e ante laccate bianco lucido. Top disponibile anche con inserto in ceramica Marmi nei colori Calacatta, Alabastro, Ardesia, matt Golden Calacatta opaco, Golden Calacatta lucido o ceramica Brown Zinc. Ripiani interni in cristallo trasparente.

Sideboards with 2 o 4 doors. Frame and top painted matt graphite or white with Canaletto walnut, burnt oak or Heritage oak doors, or frame, top and doors all polished white. Top available also with insert in ceramic Marmi Calacatta, Alabastro, Ardesia, matt Golden Calacatta, glossy Golden Calacatta or ceramic Brown Zinc. Internal shelves in clear glass.

Bahut à 2 ou 4 portes. Structure et plateau laqué graphite ou blanc opaque et portes en noyer Canaletto, rouvre brûlé ou rouvre Héritage, ou structure, plateau et portes en bois laqué blanc brillant. Plateau disponible avec insert en céramique Marmi dans les couleurs Calacatta, Alabastro, Ardesia, Golden Calacatta opaque, Golden Calacatta brillant ou Brown Zinc. Étagères intérieures en verre clair.

Aparador con 2 o 4 puertas. Estructura y sobre barnizados graphite o blanco mate y puertas en nogal Canaletto, roble ahumado o roble Heritage, o estructura, sobre y puertas barnizados blanco brillo. Sobre disponible también con detalle en cerámica Marmi en los colores Calacatta, Alabastro, Ardesia, Golden Calacatta mate, Golden Calacatta brillo o cerámica Brown Zinc. Estantes interiores en cristal transparente.

Sideboard mit 2 oder 4 Türen. Korpus und Top lackiert graphit oder weiß matt und Türen in Nussbaum Canaletto, verbrannte Eiche oder Eiche Heritage, oder mit Korpus, Top und Türen lackiert weiß glänzend. Der Top kann auch mit Keramik Marmi Einsätze in den Farben Calacatta, Alabastro, Ardesia, matt Golden Calacatta, glänzend Golden Calacatta oder Keramik Brown Zinc geliefert werden. Innenböden in Klarglas.

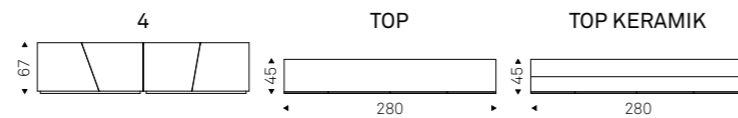
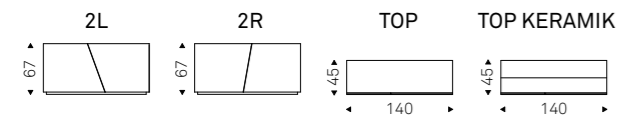



EXPLORER sideboard white - HAWAII mirrors 2E/2C/1D/1B - CHENNAI rug - BOLERO C lamp

EUROPA KERAMIK

Design

A. Lucatello & P. Cattelan

Madia con ante scorrevoli complanari e inserto nel top in ceramica Marmi nei colori Calacatta, Alabastro, Ardesia, Golden Calacatta opaco, Golden Calacatta lucido o ceramica Brown Zinc. Struttura verniciata graphite opaco. Ripiani interni in cristallo trasparente.

Sideboard with sliding doors and insert into the top in ceramic Marmi Calacatta, Alabastro, Ardesia, matt Golden Calacatta, glossy Golden Calacatta or ceramic Brown Zinc. Matt graphite painted frame. Internal shelves in clear glass.

Bahut avec portes coulissantes et insert du plateau en céramique dans les couleurs Marmi Calacatta, Alabastro, Ardesia, Golden Calacatta opaque, Golden Calacatta brillant ou Brown Zinc. Structure laqué graphite opaque. Étagères intérieurs en verre clair.

Aparador con puertas correderas y sobre con detalle en cerámica Marmi en los colores Calacatta, Alabastro, Ardesia, Golden Calacatta mate, Golden Calacatta brillo o cerámica Brown Zinc. Estructura barnizada graphite mate. Estantes interiores en cristal transparente.

Sideboard mit komplanaren Schwebetüre, Keramik Marmi Einsetze im Top, in den Farben Calacatta, Alabastro, Ardesia, matt Golden Calacatta, glänzend Golden Calacatta oder Keramik Brown Zinc. Korpus lackiert graphit matt. Innenböden in Klarglas.

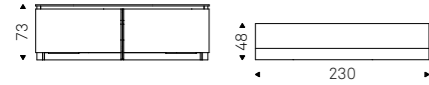



EUROPA KERAMIK sideboard Ardesia - LAMPO C lamp



Calacatta ceramic Marmi



matt Golden Calacatta ceramic Marmi



Zinc Brown ceramic Marmi

STANDARD

Design Alessio Bassan

Madia a 4 ante. Fianchi e ante verniciati graphite opaco, bianco lucido o castoro lucido. Struttura, top, maniglie e piedi verniciati graphite opaco. Ripiani interni in MDF verniciati graphite opaco.

Sideboard with 4 doors. Sides and doors matt graphite, polished white or polished castor painted. Frame, top, handles and feet matt graphite painted. Internal shelves in MDF matt graphite painted.

Bahut à 4 portes. Côtés et portes en bois laqué graphite opaque, blanc brillant ou castor brillant. Structure, plateau, poignées et pieds laqués graphite opaque. Étagères intérieurs en MDF laqué graphite opaque.

Aparador con 4 puertas. Lados y puertas barnizados graphite mate, blanco brillo o castor brillo. Estructura, sobre, tiradores y pies barnizados graphite mate. Estantes interiores en mdf lacados graphite mate.

Anrichte 4-trg. Seiten und Türen lackiert graphit matt, weiß glänzend oder biber glänzend. Gestell, Top, Griffe und Füße in graphit matt. Innenböden in MDF lackiert graphit matt.

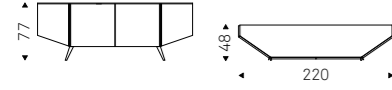

STANDARD sideboard polished white - LAMPO B lamp black - CHENNAI rug



STANDARD sideboard polished castoro - INDY 211 chair in polyurethane P03 Fango - THOR lamp

AIRPORT

Design **Giorgio Cattelan**

Libreria componibile con fissaggio a muro o a soffitto. Montanti e staffe in acciaio verniciato gofrato bianco, nero o graphite opaco. Ripiani e contenitore in legno verniciato gofrato bianco, graphite, in noce Canaletto o rovere bruciato.

Modular wall- or ceiling-hanging bookcase. Brackets and pillars in white, black or graphite embossed lacquered steel. Shelves and container in Canaletto walnut, burned oak, embossed white or graphite painted wood.

Bibliothèque à éléments avec fixation au mur ou au plafond. Montants et supports en acier gaufré blanc, noir ou graphite. Étagères et conteneur en bois gaufré blanc, graphite, en noyer Canaletto ou rouvre brûlé.

Estantería componible con montaje en pared o techo. Montantes y soportes en acero barnizado gofrado blanco, negro o graphite. Estantes y contenedor en madera barnizada gofrado blanco, graphite, nogal Canaletto o roble ahumado.

Anbau Regal mit Wand- oder Deckebefestigung. Gestell und Bügel in Stahl lackiert weiß, schwarz oder graphite gaufriert. Böden und Container in Holz lackiert weiß gaufriert oder graphite, Nussbaum Canaletto oder "verbrannte Eiche".

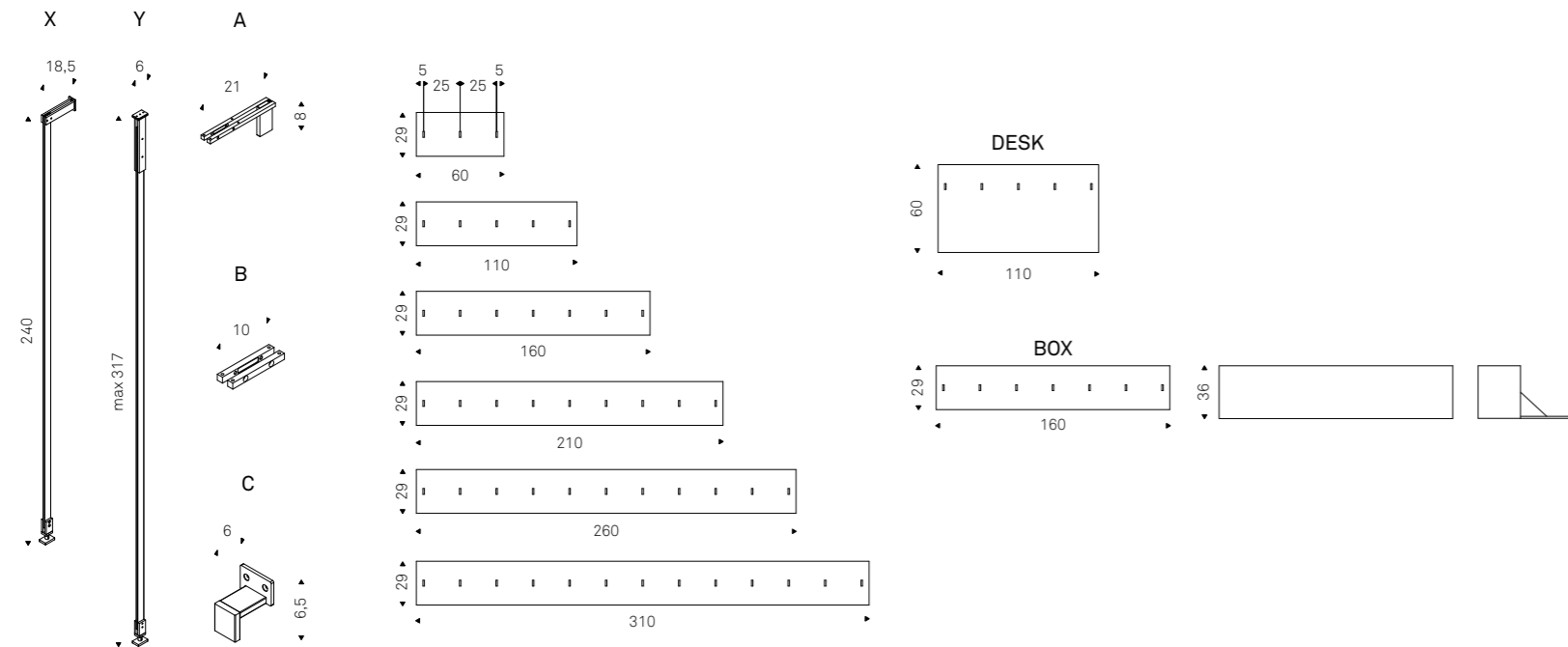

AIRPORT bookcase with graphite frame and burned oak shelves - SPIRAL coffee table with fume glass top and black base - RADJA rugs



AIRPORT bookcases black frame and burned oak shelves - lamp THOR - JAIPUR and DELHI rugs - BILLY KERAMIK coffee tables with Alabastro ceramic top and black base
 MUSA chair in soft leather 950 Tortora and burned oak - HAVANA suspension lamps

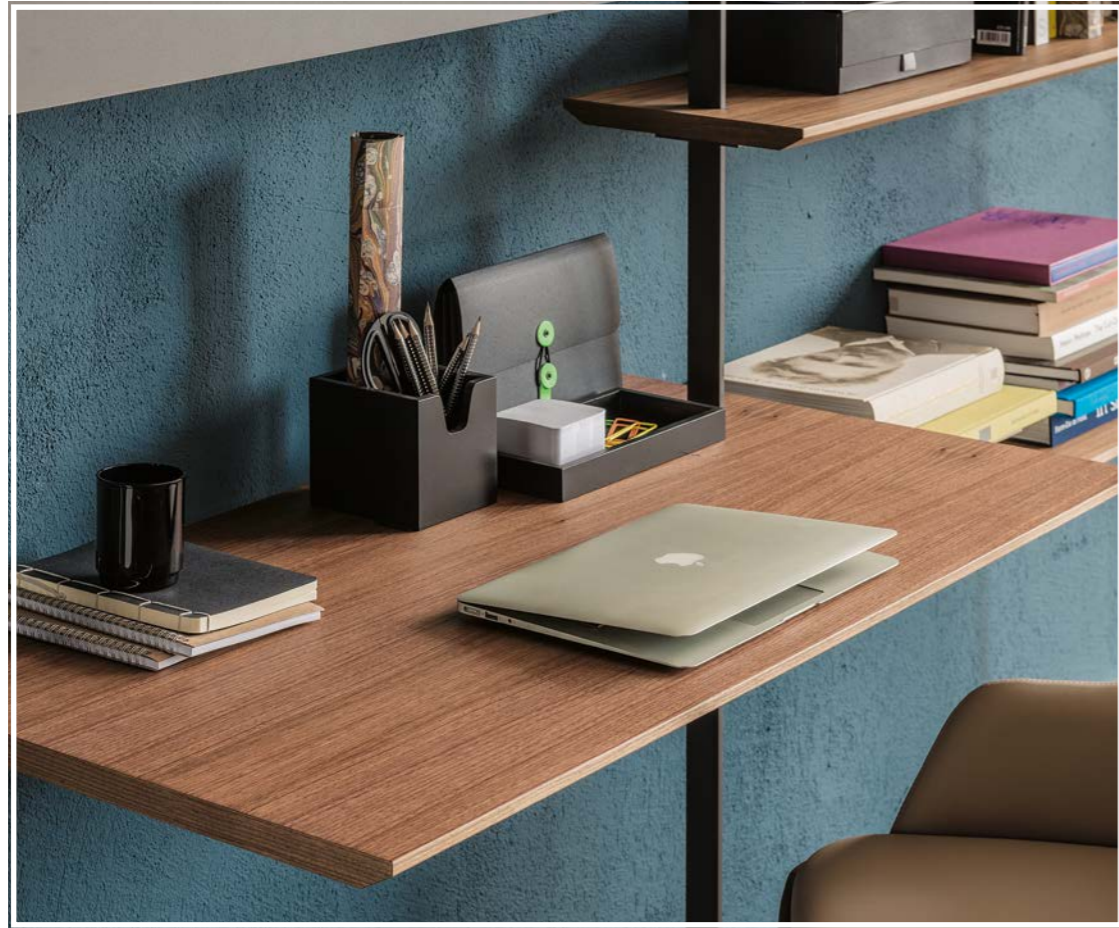

AIRPORT bookcase with graphite frame and burned oak shelves and desk
 INDY111 chair with titanium base and P02 Lino seat - MUMBAI rugs - LAMPO B lamp in black finish



HUDSON bookcases with black frame and burned oak shelves - ZOOM A lamp - MAPOON rug



HUDSON

Design **Giorgio Cattelan**

Libreria modulare con struttura in acciaio verniciato gofrato titanio, bianco, nero o graphite. Ripiani in legno verniciato gofrato bianco, graphite, in noce Canaletto o rovere bruciato. Particolari in ottone. Per il posizionamento centrostanza si consiglia l'utilizzo di almeno due moduli.

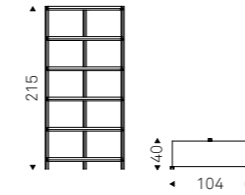

Modular bookcase with frame in titanium, white, black or graphite embossed lacquered steel. Shelves in Canaletto walnut or burned oak or embossed white or graphite painted wood. Brass details. For the freestanding use are recommended at least two modules.

Bibliothèque modulaire avec structure en acier gaufré titane, blanc, noir ou graphite. Étagères en bois gaufré blanc, graphite, en noyer Canaletto ou rouvre brulé. Détails en laiton. Pour la position autoportante: à partir de 2 modules.

Estantería modular con estructura en acero barnizado gofrado titanio, blanco, negro o graphite. Estantes en madera barnizada gofrado blanco, graphite, nogal Canaletto o roble ahumado. Detalles en latón. Para colocación en medio de sala, se aconseja montar mínimo 2.

Modular Bücherregal mit Struktur aus Stahl lackiert Titan, weiss, schwarz oder graphite gaufriert. Böden aus Holz lackiert weiß gaufriert oder graphite gaufriert, Nussbaum Canaletto oder "verbrannte Eiche". Details aus Messing. Für die Verwendung in der mittel des Raumes sind mindestens zwei Modul notwendig.





HUDSON bookcases with black frame and burned oak shelves

TOKYO

Design **Andrea Lucatello**

Libreria a soffitto con struttura e ripiani in acciaio verniciato gofrato bianco, nero o graphite e inserti in noce Canaletto. Portata massima per ripiano 4 Kg.

Bookcase with frame and shelves in white, black or graphite embossed lacquered steel and Canaletto walnut inserts. Max capacity: each shelf kg 4.

Bibliothèque avec structure et étagères en acier gaufré blanc, noir ou graphite et détails en noyer Canaletto. Capacité maximum: chaque plateau kg 4.

Estantería de techo con estructura y estantes en acero barnizado gofrado blanco, negro o graphite y detalles en nogal Canaletto. Peso máximo: cada estante kg 4.

Bücherregal mit deckenbefestigung Struktur und Böden aus Stahl lackiert weiss, schwarz oder graphite gaufriert. Holzeinsätze aus Nussbaum Canaletto. Belatbarkeit: jeder Boden kg 4.

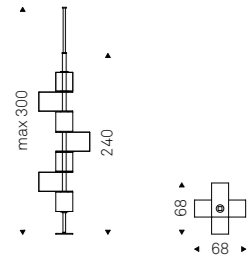

TOKYO bookcases with graphite frame and shelves - VINYL coffee tables with Madreperla top and chromed base - HAWAII B mirror in fumé finish- KARIBU lamp in black finish



ARSENAL B bookcase with black frame and graphite shelves – KUBO pouf in leather 71 Bianco

ARSENAL**Design Alessio Bassan**

Libreria modulare con struttura in acciaio verniciato gofrato titanio, bianco, nero o graphite. Ripiani in legno verniciato gofrato bianco, graphite, in noce Canaletto o rovere bruciato. Struttura assemblabile dx o sx a piacere.

Modular bookcase with frame in titanium, white, black or graphite embossed lacquered steel. Shelves in Canaletto walnut or burned oak or embossed white or graphite painted wood. The frame can be assembled right or left (as one wants).

Bibliothèque modulaire avec structure en acier gaufré titane, blanc, noir ou graphite. Étagères en bois gaufré blanc, graphite, en noyer Canaletto ou rouvre brulé. Structure à monter à gauche ou à droite.

Estantería modular con estructura en acero barnizado gofrado titanio, blanco, negro o graphite. Estantes en madera barnizada gofrado blanco, graphite, nogal Canaletto o roble ahumado. Posibilidad de montar la estructura a la derecha o a la izquierda.

Modulare Bücherregal mit Struktur aus Stahl lackiert Titan, weiss, schwarz oder graphit gaufriert. Böden aus Holz lackiert weiß gaufriert oder graphit oder Nussbaum Canaletto oder "verbrannte Eiche". Montale nach Wunsch Rechts oder Links.

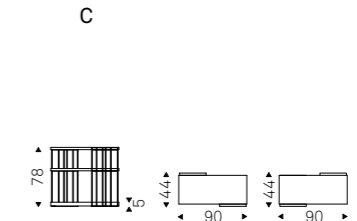
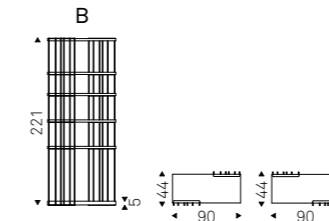
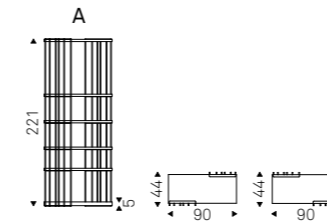



ARSENAL B bookcase with black frame and graphite shelves - MAGDA B chair in soft leather 948 Lino and wenghè



ARSENAL B bookcase with titanium frame and white shelves - MUMBAI rug - ROYALTON sideboard in white finish



JOKER bookcases in titanium finish

JOKER**Design Giorgio Cattelan**

Libreria in acciaio verniciato bianco, nero, grey, rosso o gofrato titanio. Portata massima ripiani: kg 7 cad.

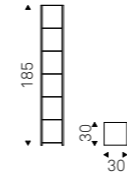

Bookcase in white, black, grey, red painted steel or titanium embossed lacquered steel. Max capacity: each shelf kg 7.

Bibliothèque en acier laqué blanc, noir, grey, rouge opaque ou en acier gaufré titane. Capacité maximum: chaque plateau kg 7.

Estantería en acero pintado blanco, negro, grey, rojo o barnizado gofrado titanio. Peso máximo cada estante kg 7.

Bücherregal aus Edelstahl lackiert weiß, schwarz, grey, rot oder lackiert Titan gaufriert. Belastbarkeit: jeder Boden kg 7.



JOKER bookcases in white finish



SPIRAL coffee table with black chromed base and fumé glass top

SPIRAL**Design Giorgio Cattelan**

Tavolino con base in acciaio verniciato gofrato nero, titanio o cromo nero e piano curvato trasparente o fumé.

Coffee table with black chrome or black or titanium embossed lacquered steel base and curved clear or fumé glass top.

Table basse avec base en acier gaufré noir, titane ou chromé noir et verre courbé clair ou fumé.

Mesita con base en acero barnizado gofrado negro, titanio o cromado negro y cristal curvado transparente o fumé.

Couchtisch mit Basis aus Stahl lackiert schwarz oder titan gaufriert oder verchromt schwarz. Platte aus gebogenem Glas klar oder fumé.



SPIRAL coffee table with black chromed base and clear glass top



SPIRAL coffee table with black chromed base and fume glass top - LAMPO A lamp in titanium finish - JANEIRO mirror in Canaletto walnut

BIPLANE

Design **Paolo Cattelan**

Tavolino con struttura in acciaio verniciato gofrato titanio o nero. Piano superiore in cristallo trasparente o fumé. Piano inferiore in ceramica Marmi Calacatta o Ardesia. Particolari in bronzo.

Coffee table with embossed titanium or black painted steel structure. Clear or fumé glass upper top and Marmi Calacatta or Ardesia ceramic lower top. Brass details.

Table basse avec structure en acier gaufré titane ou noir. Plateau supérieur en verre clair ou fumé et Marmi Calacatta ou Ardesia. Détails en bronze.

Mesita con estructura en acero barnizado gofrado titanio o negro. Sobre superior en cristal transparente o fumé y sobre inferior en cerámica Marmi Calacatta o Ardesia. Detalles en bronce.

Coufchtisch mit Basis aus Stahl lackiert Titan oder schwarz gaufriert. Obere Platte aus klar Glass oder fumé und untere Platte aus Keramik Marmi Calacatta oder Ardesia. Details aus Messing.

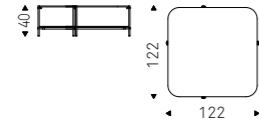
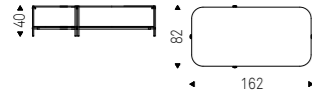



BIPLANE coffee table with black frame, fumè glass upper top and Ardesia ceramic lower top - TIFFANY sideboards in soft leather 956 Atlantico and graphite frame.

VINYL

Design Oriano Favaretto

Tavolino con base in acciaio cromato, verniciato gofrato nero o titanio. Piano in vetro artistico di Murano nei colori petrolio o madreperla. Disco realizzato a mano secondo le antiche tecniche di lavorazione Muranesi in pasta di vetro di Murano con effetto madreperla. Imperfezioni, striature, variazioni cromatiche e irregolarità di forma sono caratteristiche della lavorazione manuale e non sono da considerarsi difetti.

Coffee table with base in chromed steel, embossed black or titanium lacquered steel. Murano artistic glass top in Petrolio or Madreperla colors. Handmade top according to the ancient techniques of Murano made of Murano vitreous paste with Madreperla effect. Imperfections, streaks, color variations and irregularities of shape are characteristic of the handmade work and are not to be considered as defects.

Table basse avec base en acier chromé, gaufré noir ou titane. Plateau en verre de Murano dans les couleurs Petrolio ou Madreperla. Top fabriqué à la main, selon une technique traditionnelle de Murano, en pâte de verre de Murano avec effet Madreperla. Imperfections, rayures, variations chromatiques et irrégularités dans la forme sont des caractéristiques du travail manuel et il ne faut pas les considérer comme défauts.

Mesita con base en acero cromado, barnizado gofrado negro o titanio. Sobre en cristal artístico de Murano colores petróleo o madreperla. Sobre/disco realizado a mano según las antiguas técnicas artesanales de los maestros de Murano en pasta de vidrio con efecto madreperla. Imperfecciones, rayas, cambios de tonalidad son características de la producción manual y no son defectos.

Couchtisch mit Basis aus verchromtem Stahl, lackiert schwarz gaufriert oder Titan. Platte aus Murano künstlerische in Petrolio oder Madreperla Farben. Handgefertigt Scheibe nach alten Muranesi Techniken aus Murano Glaspaste mit Perlmutteffekt. Streifen, Farbvariationen und Unregelmäßigkeiten in der Form sind Eigenschaften der spezielle Verarbeitung des Materials und sind nicht als Fehler zu betrachten.



VINYL coffee tables with titanium base and Madreperla top



VINYL coffee tables with chromed steel base and Madreperla top - HAWAII B mirror fumé finish



VINYL coffee tables with black base and Petrolio top

NIDO**Design Brogliato Traverso**

Tavolino con base in acciaio verniciato gofrato bianco, nero o graphite. Piano in acciaio verniciato gofrato bianco, nero o graphite nelle versioni A e B. Piano in appoggio in cristallo trasparente nelle versioni C e D.

Coffee table with white, black or graphite embossed steel base. Top in white, black or graphite embossed steel in the A and B versions. Top in clear glass in the C and D versions. The glass top is laid on the base.

Table basse avec base en acier gaufré blanc, noir ou graphite. Plateau en acier gaufré blanc, noir ou graphite dans les versions A et B. Plateau en verre clair dans les versions C et D. Plateau d'appui en verre clair.

Mesita con base en acero barnizado gofrado blanco, negro o graphite. Sobre en acero barnizado gofrado blanco, negro o graphite en le versiones A y B. Sobre en cristal transparente en apoyo en le versiones C y D.

Couchtisch mit Basis aus Stahl lackiert weiß, schwarz oder graphit gaufriert. Platte aus Stahl lackiert weiß, schwarz oder graphit gaufriert in den Versionen A und B. Platte aus klarem Glas in den Versionen C und D. Nur die Platteversion aus Glas ist auf die Basis gelegt.

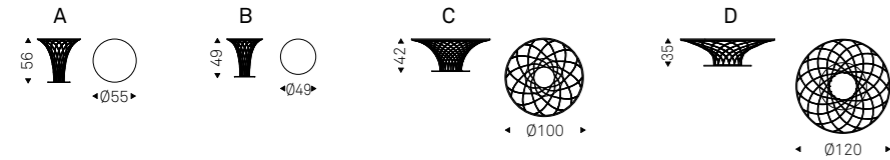

NIDO / B



NIDO / A



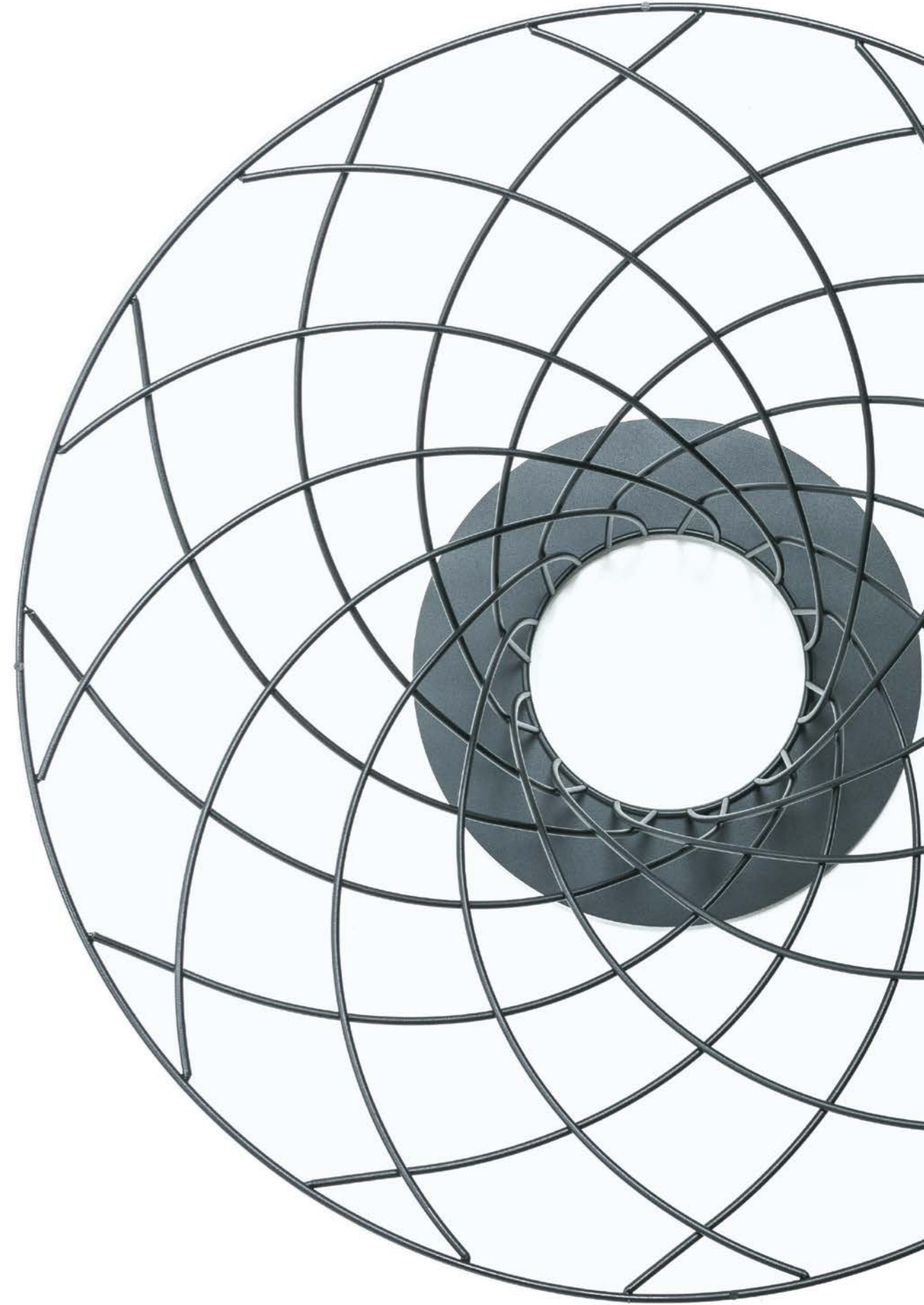

NIDO A and B coffee tables with black base and black embossed steel top - MUMBAI rug - JOKER bookcases in titanium finish - SABLERA lamp



BILLY KERAMIK coffee tables with black base and Ardesia ceramic top

BILLY KERAMIK**Design Studio Kronos**

Tavolino con base in acciaio cromato o verniciato goffrato nero. Piano in ceramica Marmi nei colori Calacatta, Alabastro, Ardesia, Portoro opaco o Portoro lucido.

Coffee table with base in chromed steel or embossed black lacquered steel. Marmi Calacatta, Alabastro, Ardesia, matt Portoro or glossy Portoro ceramic top.

Table basse avec base en acier chromé ou gaufré noir. Plateau en céramique Marmi dans les couleurs Calacatta, Alabastro, Ardesia, Portoro opaque ou Portoro brillant.

Mesita con base en acero cromado o barnizado gofrado negro. Sobre en cerámica Marmi colores Calacatta, Alabastro, Ardesia, Portoro mate o Portoro brillo.

Couchtisch mit Basis aus verchromtem Stahl oder lackiert schwarz gaufriert. Platte in Keramik Marmi in den Farben Calacatta, Alabastro, Ardesia, matt Portoro oder glänzend Portoro.

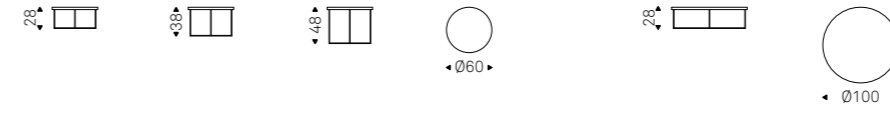

BILLY KERAMIK coffee tables with black base and Alabastro /Calacatta and Ardesia ceramic tops



BILLY KERAMIK coffee tables with black base and Alabastro ceramic top - MAPOON rug

ATARI**Design Giorgio Cattelan**

Tavolino con base in massello di noce Canaletto o noce tinto rovere bruciato. Piano in appoggio in cristallo trasparente.

Coffee table with solid Canaletto walnut or burned oak stained walnut. Clear glass top. The top is laid on the base.

Table basse avec base en noyer Canaletto massif ou noyer teinté rovere brûlé. Plateau en appui en verre clair.

Mesita con base en madera maciza nogal Canaletto o nogal pintado roble ahumado. Sobre en apoyo en cristal transparente.

Couchtisch mit Basis aus massiv Nussbaum Canaletto oder Nussbaum gebeizt "verbrannte Eiche". Platte in Klarglas. Platte auf die Basis gelegt.

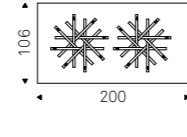
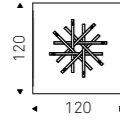
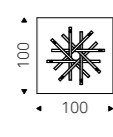



ATARI coffee table - MAPOON rugs - WALLY bookcases Ottanio

KITANO**Design Paolo Cattelan**

Tavolino con base in acciaio verniciato bianco, nero o graphite opaco. Piano in ceramica Marmi nei colori Calacatta, Alabastro, Ardesia, Portoro opaco o Portoro lucido.

Coffee table with base in matt white, black or graphite painted steel. Marmi Calacatta, Alabastro, Ardesia, matt Portoro or glossy Portoro ceramic top.

Table basse avec base en acier laqué blanc, noir ou graphite opaque. Plateau en céramique Marmi dans les couleurs Calacatta, Alabastro, Ardesia, Portoro mate ou Portoro brillant.

Mesita con base en acero barnizado blanco, negro o graphite. Sobre en cerámica Marmi colores Calacatta, Alabastro, Ardesia, Portoro mate o Portoro brillo.

Couchtisch mit Basis aus Stahl lackiert matt weiß, schwarz oder graphit. Platte in Keramik Marmi in den Farben Calacatta, Alabastro, Ardesia, matt Portoro oder glänzend Portoro.

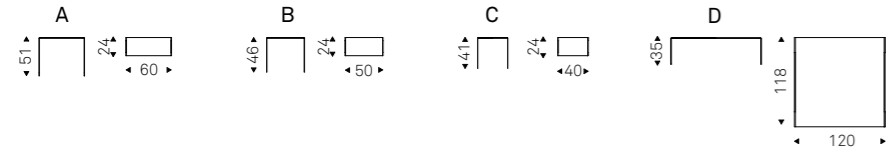

KITANO coffee tables with black base and Alabastro ceramic top



KITANO coffee table with black base and Alabastro ceramic top - LAMPO C lamp in black finish



KITANO D coffee table with black base and Ardesia ceramic top - MUMBAI rug



KITANO coffee tables with black base and Ardesia ceramic top

STING

Design **Paolo Cattelan**

Tavolino con base in acciaio verniciato gofrato titanio, graphite o nero. Piano in ceramica Marmi nei colori Calacatta, Ardesia, Portoro opaco o Portoro lucido.

Coffee table with base in titanium, black or graphite embossed lacquered steel. Plateau en céramique Marmi dans les couleurs Calacatta, Ardesia, matt Portoro or glossy Portoro top.

Table basse avec base en acier gaufré titane, noir ou graphite. Plateau en céramique Marmi dans les couleurs Calacatta, Ardesia, Portoro opaque ou Portoro brillant.

Mesita con base en acero barnizado gofrado titanio, negro o graphite. Sobre en cerámica Marmi colores Calacatta, Ardesia, Portoro mate o Portoro brillo.

Couchtisch mit Basis aus Edelstahl lackiert titan, schwarz oder graphit gaufriert. Platte in Keramik Marmi Calacatta, Ardesia, matt Portoro oder glänzend Portoro.



STING coffee tables with titanium base and Calacatta ceramic top - RADJA rug



GLENN

Design **Philip Jackson**

Specchio da parete o da terra tutto in cristallo specchiato, specchiato fumé o specchiato bronzo.

Wall or floor mirror with the whole frame in mirrored, smoked grey or bronze mirrored glass.

Miroir de mur ou de sol tout en verre miroité, miroité fumé ou miroité bronze.

Espejo de pared o suelo todo en cristal reflejado, reflejado fumé o reflejado bronzo.

Wandspiegel oder Bodenspiegel ganz aus Glas verspiegelt, fumé oder Bronze verspiegeltem Glas.

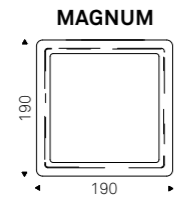
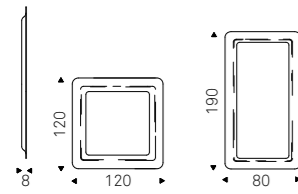

GLENN mirror 120x120 mirrored glass - PRISMA sideboard in wood burned oak



GLENN mirrors 80x190 in bronze finish



GLENN MAGNUM

Design **Philip Jackson**

Specchio da parete o da terra tutto in cristallo specchiato, specchiato fumé o specchiato bronzo.

Wall or floor mirror with the whole frame in mirrored, smoked grey or bronze mirrored glass.

Miroir de mur ou de sol tout en verre miroité, miroité fumé ou miroité bronze.

Espejo de pared o suelo todo en cristal reflejado, reflejado fumé o reflejado bronzo.

Wandspiegel oder Bodenspiegel ganz aus Glas verspiegelt, fumé oder Bronze verspiegeltem Glas.

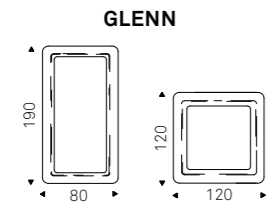
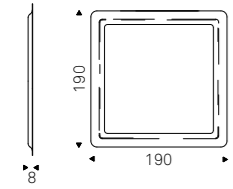

GLENN MAGNUM mirror 190x190 in bronze finish - TOKYO bookcase with black shelves - CHENNAI rug - STANDARD sideboard in white finish - LAMPO B lamp in black finish

HAWAII

Design Studio Kronos

Specchio da parete tutto in cristallo specchiato, specchiato fumé o specchiato bronzo con bordi bisellati. Supporto a parete con possibilità di fissaggio in diverse posizioni.

Wall mirror in mirrored, smoked grey or bronze mirrored glass with bevelled edges. Wall bracket with fixing possibilities in different positions.

Miroir mural en verre miroité, miroité fumé ou miroité bronze avec bords biseautés. Support mural avec différentes ancrages.

Espejo de pared todo en cristal reflejado, reflejado fumé o reflejado bronzo y bordes biselados. Soporte de pared que permite un montaje en distintas posiciones.

Wandspiegel aus verspiegeltem, fumé oder Bronze verspiegeltem Glas mit facettierten Kanten. Wandhalterung mit Anschlussmöglichkeiten in verschiedenen Positionen.

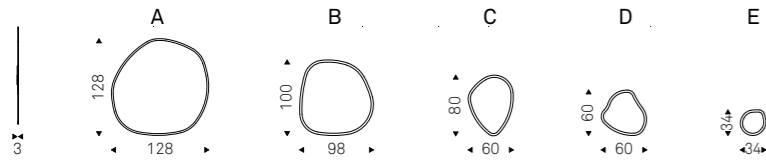

HAWAII mirrors 1B mirrored / 1C bronze and 1C smoke / 1D smoke / 2E bronze - EXPLORER sideboard 4 with white frame - BOLERO C lamp in black finish - CHENNAI rug



HAWAII B mirror in fumé finish - VINYL coffee tables with chromed steel base and Madreperla top.



HAWAII mirrors 1B mirrored/ 1C bronze and 1C smoke/ 1D smoke / 2E bronze - BOLERO C lamp in black finish

EMERALD WOOD

Design **Paolo Cattelan**

Specchio da parete con cornice in noce Canaletto, rovere bruciato o frassino laccato poro aperto nero opaco.

Wall mirror with frame in Canaletto walnut, burned oak or open pore matt black ashwood.

Miroir de mur avec cadre en noyer Canaletto, rouvre brûlé ou frêne laqué noir opaque pore ouvert.

Espejo de pared con marco en nogal Canaletto, roble ahumado o fresno barnizado negro mate a poro abierto.

Wandspiegel mit Rahmen aus Nussbaum Canaletto, "verbrannte Eiche" oder Esche offenporig lackiert schwarz matt.

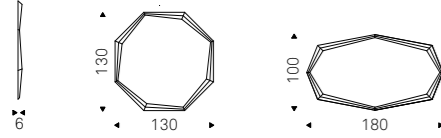

EMERALD WOOD mirror in black ashwood



**EMERALD**Design **Paolo Cattelan**

Specchio da parete o da terra tutto in cristallo specchiato o specchiato fumé.

Wall or floor mirror with the whole frame in mirrored glass or fumé glass.

Miroir de mur ou de sol tout en verre miroité ou miroité fumé.

Espejo de pared o suelo todo en cristal reflejado o reflejado fumé.

Wandspiegel oder Bodenspiegel ganz aus Glas verspiegelt oder verspiegelt fumé.

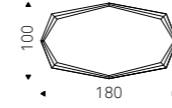
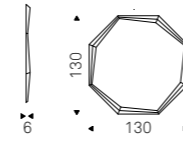
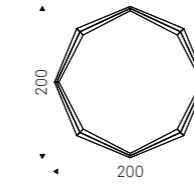
**MAGNUM**



EMERALD MAGNUM mirror - KLIRR table - DUMBO chairs in soft leather 948 Lino and black frame - SABLIER lamps with iride fumé lampshades



JANEIRO mirror 120x110 in Canaletto walnut - TIFFANY sideboard in soft leather 956 Atlantico and graphite frame

JANEIRO

Design **Andrea Lucatello**

Specchio da parete con cornice in noce Canaletto, rovere bruciato o frassino laccato poro aperto nero opaco. Supporto a parete con possibilità di fissaggio in diverse posizioni.

Wall mirror with frame in Canaletto walnut, burned oak or open pore matt black ashwood. Wall bracket with fixing possibilities in different positions.

Miroir de mur avec cadre en noyer Canaletto, rouvre brulé ou frêne laqué noir opaque pore ouvert. Support mural avec différentes ancrages.

Espejo de pared con marco en nogal Canaletto, roble ahumado o fresno barnizado negro mate a poro abierto. Soporte de pared que permite un montaje en distintas posiciones.

Wandspiegel mit Rahmen aus Nussbaum Canaletto, "verbrannte Eiche" oder Esche offenporig lackiert schwarz matt. Wandhalterung mit Anschlussmöglichkeiten in verschiedenen Positionen.

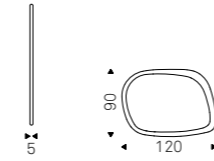

JANEIRO MAGNUM

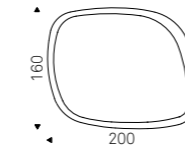

JANEIRO MAGNUM

Design **Andrea Lucatello**

Specchio da parete con cornice in noce Canaletto, rovere bruciato o frassino laccato poro aperto nero opaco. Supporto a parete con possibilità di fissaggio in diverse posizioni.

Wall mirror with frame in Canaletto walnut, burned oak or open pore matt black ashwood. Wall bracket with fixing possibilities in different positions.

Miroir de mur avec cadre en noyer Canaletto, rovere brulé ou frêne laqué noir opaque pore ouvert. Support mural avec différentes ancrages.

Espejo de pared con marco en nogal Canaletto, roble ahumado o fresno barnizado negro mate a poro abierto. Soporte de pared que permite un montaje en distintas posiciones.

Wandspiegel mit Rahmen aus Nussbaum Canaletto, "verbrannte Eiche" oder Esche offenporig lackiert schwarz matt. Wandhalterung mit Anschlussmöglichkeiten in verschiedenen Positionen.

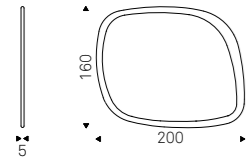

JANEIRO

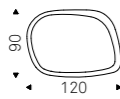

JANEIRO mirror 200x160 in Canaletto walnut - AIR coat hangers in titanium finish - INDY 111 chair with titanium base and P02 Lino seat

JANEIRO mirror 200x160 in black finish

SAMIR**Design Ennio Pasini**

Specchio da parete interamente in cristallo specchiato. Supporto a parete con possibilità di fissaggio in 4 posizioni.

Wall mirror all in mirrored glass. Wall bracket with fixing possibilities in 4 positions.

Miroir mural en verre miroité. Support à mur avec 4 ancrages.

Espejo de pared totalmente en cristal reflejado. Soporte de pared que permite un montaje en 4 posiciones.

Wandspiegel komplett in Glas verspiegelt, 4 mögliche Befestigungspositionen.



CAMELOT

Design **STC Studio**

Specchio da parete in
cristallo specchiato e cornice
in cristallo specchiato
curvato.

Wall mirror in mirrored glass
with curved mirrored glass
frame.

Miroir mural en verre miroité
avec cadre en verre miroité
courbé.

Espejo de pared en cristal
reflejado con marco en cristal
curvado reflejado.

Wandspiegel aus
verspiegeltem Glas mit
Rahmen aus gebogenem
verspiegeltem Glas.

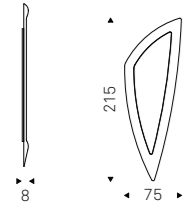



MOMENT R mirror in mirrored glass - MEDUSA B lamp - NEMO CONSOLE with graphite base and LM05 walnut top

MOMENT

Design Brogliato Traverso
Specchio/orologio in
cristallo serigrafato
specchiato o specchiato
fumé con lancette in
alluminio nero.

Mirror/clock in silk-screen
printing, mirrored or fumé
glass with black aluminium
clock hands.

Miroir/Montre en cristal
avec sérigraphie miroitée ou
miroitée fumé avec détails
en aluminium noir.

Espejo/reloj en cristal
serigrafado reflejado o
reflejado fumé con agujas
en aluminio negro.

Spiegel/Uhr in Glas
seibgedruckt und
verspiegelt oder verspiegelt
fumé mit Uhrzeiger in
Aluminium schwarz.



MOMENT S mirror in mirrored glass

FOREVER

Design **Brogliato Traverso**

Specchio/orologio in
cristallo specchiato o
specchiato fumé con
lancette in alluminio nero.

Mirror/clock in mirrored
or fumé glass with black
aluminium clock hands.

Miroir/Montre en cristal
miroité ou miroité fumé avec
aiguilles en aluminium noir.

Espejo/reloj en cristal
reflejado o reflejado fumé
con agujas en aluminio
negro.

Spiegel/Uhr in Glas
verspiegelt oder verspiegelt
fumé mit Uhrzeiger in
schwarz Aluminium.



FOREVER ©

301

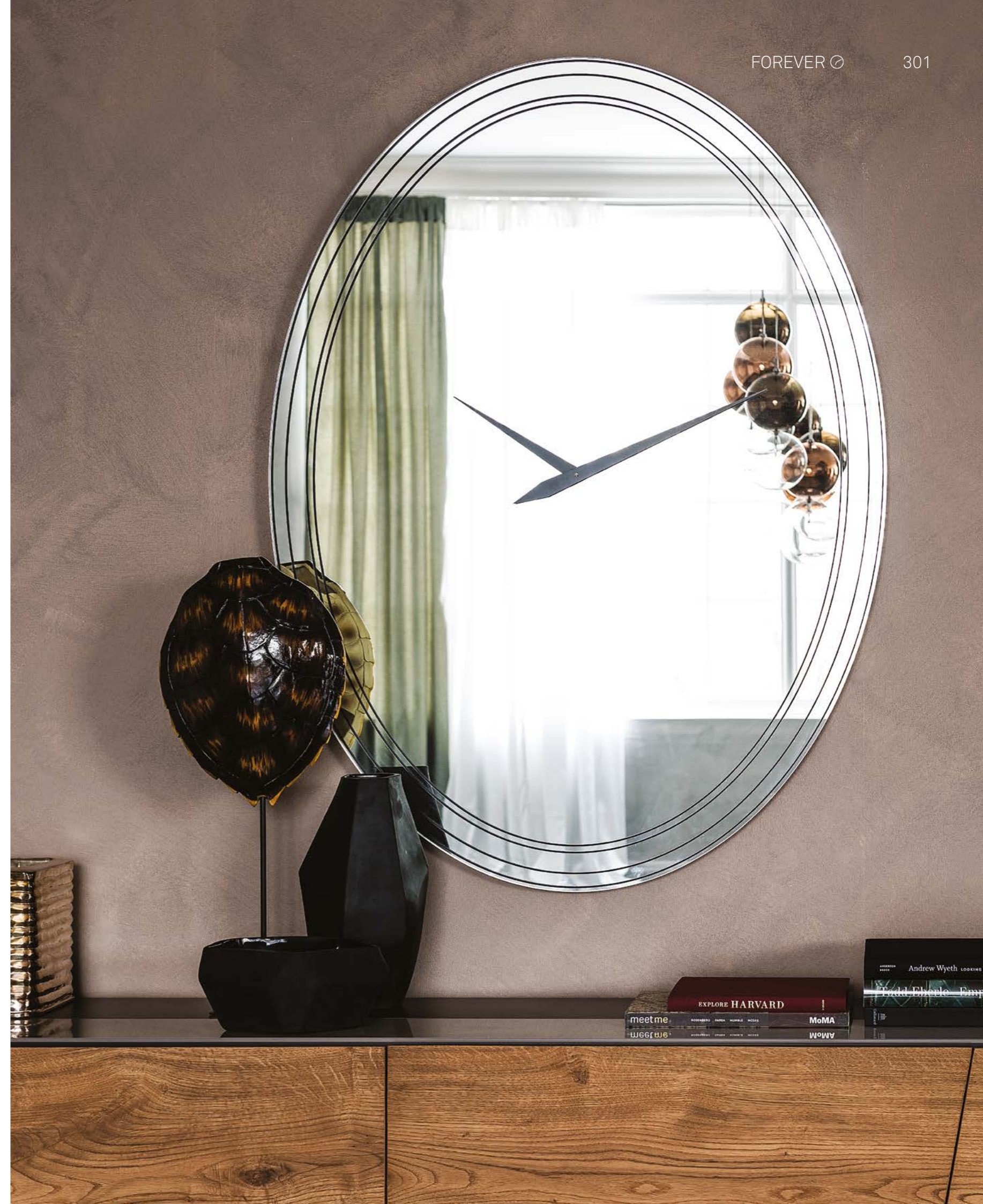

CELLINI**Design Studio Kronos**

Lampada a soffitto con telaio in acciaio Nichel satinato. Paralume composto da catenelle in alluminio nichelato. Lampadina inclusa.

Ceiling lamp with satin Nickel stainless steel frame. Lampshade made up of nickel-plated aluminium chains. Bulb included.

Lampadaire avec structure en acier Nickel satiné. Diffuseur composé par chaîne en aluminium nickelé. Ampoule comprise.

Lámpara de techo con estructura en acero Níquel satinado. Pantalla con cadenas en aluminio niquelado. Bombilla incluida.

Hängelampe mit Stahlgestell in Nickel satiniert. Lampenschirm aus vernickeltem Aluminium Ketten. Leuchtmittel enthalten.

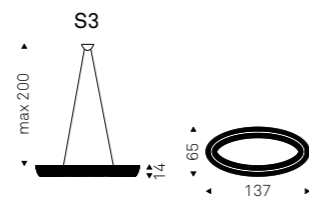
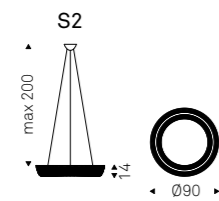
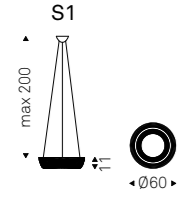

CELLINI S2 lamp - SPYDER table with Heritage oak base and clear glass top



CELLINI S3 lamp



CLOUD

Design **Oriano Favaretto**

Lampada a soffitto e abat-jour. Abat-jour con cristallo iride e base in acciaio Nichel satinato. Lampada a soffitto con paralume in cristallo iride o fumé. Attacco a soffitto in acciaio Nichel satinato. 1: attacco singolo. 2/6: attacco rotondo da 2 a 6 paralumi. 7/12: attacco rotondo da 7 a 12 paralumi. Lampadina inclusa.

Ceiling or table lamp. Table lamp with lampshade in Iride glass and satin Nickel base. Ceiling lamp with lampshade in Iride glass or smoked grey glass. 1: single plate. 2/6: round ceiling plate for 2/6 lampshades. 7/12: round ceiling plate for 7/12 lampshades. Bulb included.

Lampadaire et lampe de table. Lampe de table en verre Iride et base en acier Nickel satiné. Lampadaire avec diffuseur en verre Iride ou fumé. 1: culot single. 2/6: culot rond de 2/6 abat-jours. 7/12: culot ronde de 7/12 abat-jours. Ampoule comprise.

Lámpara de techo y sobremesa. Sobremesa en cristal iride y base en acero Niquel satinado. Lámpara de techo con pantalla en cristal iride o fumé. Soporte de techo en acero Niquel satinado. 1: soporte único. 2/6 soporte redondo para 2/6 pantallas. 7/12: soporte redondo para 7/12 pantallas. Bombilla incluida.

Hängelampe oder Tischlampe. Tischlampe mit Lampenschirm in Iride Glas und Basis in Nickel satiniert. Hängelampe mit Lampenschirm in Kristall Iride oder Fumè Glas. Stahl. 1: Einzelne Anschluss. 2/6: Runde Anschluss für 2/6 Lampenschirme. 7/12: Runde Anschluss für 7/12 Lampenschirme. Leuchtmittel enthalten.

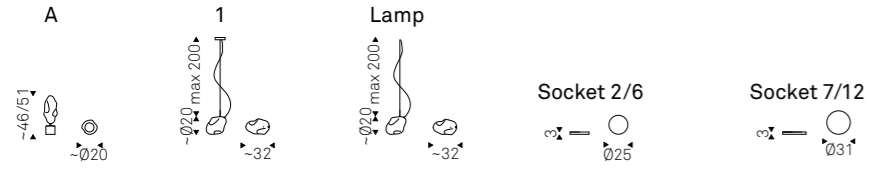



CLOUD lamps in fumè glass

POSEIDON

Design **Silver Studio**

Lampada da soffitto con 18 o 24 luci. Struttura in acciaio verniciato nero opaco o gofrato titanio e paralume in cristallo fumé. Lampadine incluse.

Ceiling lamp with 18 or 24 bulbs. Frame in matt black or embossed titanium steel and lampshade in fumé glass. Bulbs included.

Lampadaire avec 18 ou 24 ampoules. Structure en acier laqué noir opaque ou gaufré titane et diffuseurs en verre fumé. Ampoules comprises.

Lámpara de techo con 18 o 24 bombillas. Estructura en acero barnizado negro mate o titanio gofrado y pantallas en cristal fumé. Bombillas incluidas.

Hängelampe mit 18 oder 24 Leuchtmittel. Gestell matt schwarz lackiert oder titan gaufriert und Lampenschirm aus fumé Glas. Leuchtmittel enthalten.

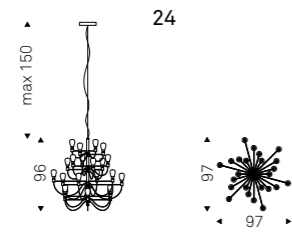
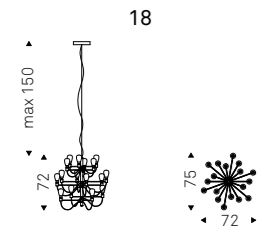

POSEIDON 24 lamp in black finish



POSEIDON 18 lamps in titanium finish

SABLIER

Design **Oriano Favaretto**

Lampada a soffitto e abat-jour con paralume in cristallo trasparente o mix (iride-fumé) e attacco a soffitto in acciaio cromo nero. 1: attacco singolo. 12: attacco rotondo da 2 a 12 paralumi. 24: attacco rotondo da 13 a 24 paralumi. Lampadina inclusa.

Ceiling or table lamp with lampshades in clear glass or mixed glass (iride-fumé) and ceiling plate in black chrome steel. 1: single plate. 12: round ceiling plate for 2/12 lampshades. 24: round ceiling plate for 13/24 lampshades. Bulb included.

Lampadaire et lampe de table avec abat-jour en verre clair ou mix (iride-fumé) et fixation au plafond en acier chromé noir. 1: culot single. 12: culot rond de 2/12 abat-jours. 24: culot rond de 13/24 abat-jours. Ampoules comprises.

Lámpara de techo y sobremesa con pantalla en cristal transparente o mix (iride-fumé). Soporte de techo en acero cromo negro. 1: soporte único. 12: soporte redondo para 2/12 pantallas. 24: soporte redondo para 13/24 pantallas. Bombilla incluida.

Hänge- oder Tischlampe mit Lampenschirm aus transparentem oder mix (iride-fumé) Glas. Deckenbefestigung aus schwarz verchromtem Stahl. 1: Einzelne Anschluss. 12: Runde Anschluss für 2/12 Lampenschirme. 24: Runde Anschluss für 13/24 Lampenschirme. Leuchtmittel enthalten.

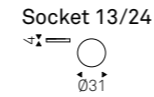
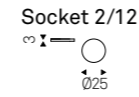
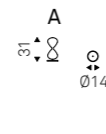
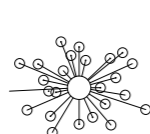
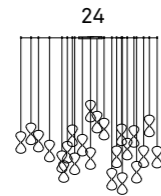
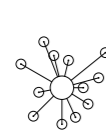
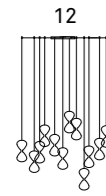

SABLIER A lamp in mixed glass





SABLIER lamps in mixed glass - PREMIER KERAMIK table with graphite base and Alabastro ceramic top





ASIA lamps in grey and bronze finish

**ASIA****Design Oriano Favaretto**

Lampada a soffitto con attacco in acciaio cromo nero e paralume in ceramica artistica dipinta a mano con smalti e metalli pregiati, disponibile nei colori blu cobalto, bicolore bianco-bronzo o bicolore grigio-bronzo. Lampadina non inclusa.

Ceiling lamp with black chrome steel ceiling plate. Lampshade in artistic ceramic hand-painted with precious metals and glazes in cobalt blue or bicolor white-bronze or grey-bronze. Bulb not included.

Lampadaire avec attaque en acier chromé noir. Diffuseur en céramique artistique peinte à la main avec émaillages et métaux fins, disponible dans les couleurs bleu cobalt ou en bicolore blanc-bronze ou gris-bronze. Ampoule non comprise.

Lámpara de techo con soporte en acero cromo negro y pantalla en cerámica pintada a mano con esmaltes y metales preciosos disponible en color azul cobalto o bicolore blanco-bronze o gris-bronze. Bombilla no incluida.

Hängelampe mit Anschluss aus schwarz verchromtem Stahl. Lampenschirm aus handgemaltem Keramik mit Glasuren und Metalle. Verfügbar in der Farbe kobaltblau oder zweifarbige Versionen weiss-bronze / grau-bronze. Leuchtmittel nicht enthalten.

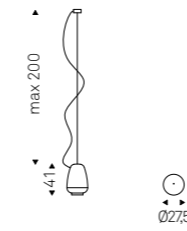

ASIA lamps in grey and bronze finish - AIRPORT bookcase

RAVEL

Design Oriano Favaretto

Lampada a soffitto con struttura in acciaio verniciato nero opaco e paralume allungabile in caoutchouc nero. Lampadina inclusa.

Ceiling lamp with frame in matt black steel and black caoutchouc extensible lampshade. Bulb included.

Lampadaire avec structure en acier laqué noir opaque et diffuseur en caoutchouc noir extensible. Ampoule comprise.

Lámpara de techo con estructura en acero barnizado negro mate y pantalla extensible en goma natural negra. Bombilla incluida.

Regelbare Hängelampe mit Gestell aus Stahl lackiert matt schwarz und Lampenschirm aus schwarzem Kautschuk. Leuchtmittel enthalten.

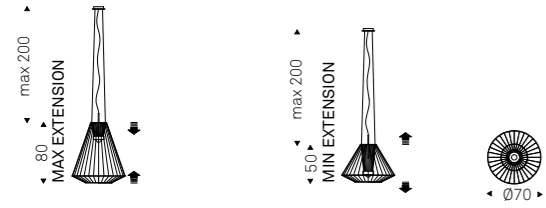

BYBLOS**Design Archirivolto**

Lampada da soffitto e da terra con rivestimento in maglia elasticizzata nei colori cenere, smoke, graphite, nero o blu. Versione da soffitto con struttura in metacrilato fumé. Lampada da terra con struttura in acciaio e metacrilato fumé, base in acciaio verniciato gofrato nero. Lampadina non inclusa.

Ceiling lamp and floor lamp. Ceiling lamp with smoked grey methacrylate frame. Floor lamp with steel and smoked grey methacrylate frame with black embossed laquered steel base. Lampshade in stretch knited fabric in ash, smoke, graphite, black or blue colors. Ampoule non comprise.

Lampadaire et lampe de sol. Lampadaire avec structure en méthacrylate fumé. Lampe de sol avec structure en acier et méthacrylate fumé, base en acier gaufré noir. Diffuseur revêtu en maille élastique en couleur cendre, smoke, graphite, noir ou bleu. Ampoule non comprise.

Lámpara de techo y de suelo. Lámpara de techo con estructura en metacrilato fumé. Lámpara de suelo con estructura en acero y metacrilato fumé, base en acero barnizado gofrado negro. Pantalla revestida con material elástico en color ceniza, smoke, graphite, negro o azul. Bombilla no incluida.

Hängelampe und Stehlampe. Hängelampe mit Gestell in Methacrylat fumé. Stehlampe mit Gestell aus Stahl und Methacrylat fumé, Basis aus Stahl schwarz gaufriert. Schirmbezug aus Stretch-Gewebe in den Farben cenere, smoke, graphit, schwarz oder blau. Leuchtmittel nicht enthalten.

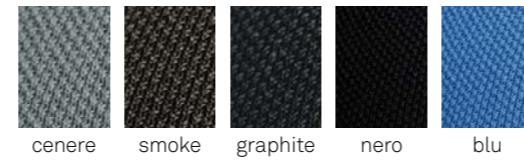
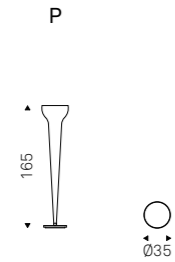
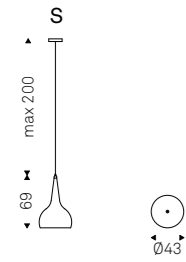

BYBLOS P lamp



BYBLOS S lamps in graphite, ash and smoke finish



ZOOM lamps in bronze finish

ZOOM

Design Studio Kronos

Lampada a soffitto o parete in acciaio verniciato bronzo satinato o cromo nero. 20/30/40: attacco singolo. 2/6: attacco rotondo da 2 a 6 paralumi. 7/12: attacco rotondo da 7 a 12 paralumi. Lampadina non inclusa.

Ceiling lamp or wall lamp in satin bronze steel or black chrome steel. 20/30/40: single plate. 2/6: round ceiling plate for 2/6 lampshades. 7/12: round ceiling plate for 7/12 lampshades. Bulb not included.

Lampadaire ou applique en acier verni bronze satiné ou acier chromé noir. 20/30/40: culot single. 2/6: culot rond de 2/6 abat-jours. 7/12: culot rond de 7/12 abat-jours. Ampoule non comprise.

Lámpara de techo o a pared en acero barnizado bronzo satinado o en cromo negro. 20/30/40: soporte de techo único. 2/6: soporte de techo redondo para 2/6 pantallas. 7/12: soporte de techo redondo para 7/12 pantallas. Bombilla no incluida.

Hängelampe oder Wandlampe aus lackiertem Bronze satiniert oder schwarz verchromtem Stahl. 20/30/40: Einzelne Anschluss. 2/6: Runde Anschluss für 2/6 Lampenschirme. 7/12: Runde Anschluss für 7/12 Lampenschirme. Leuchtmittel nicht enthalten.

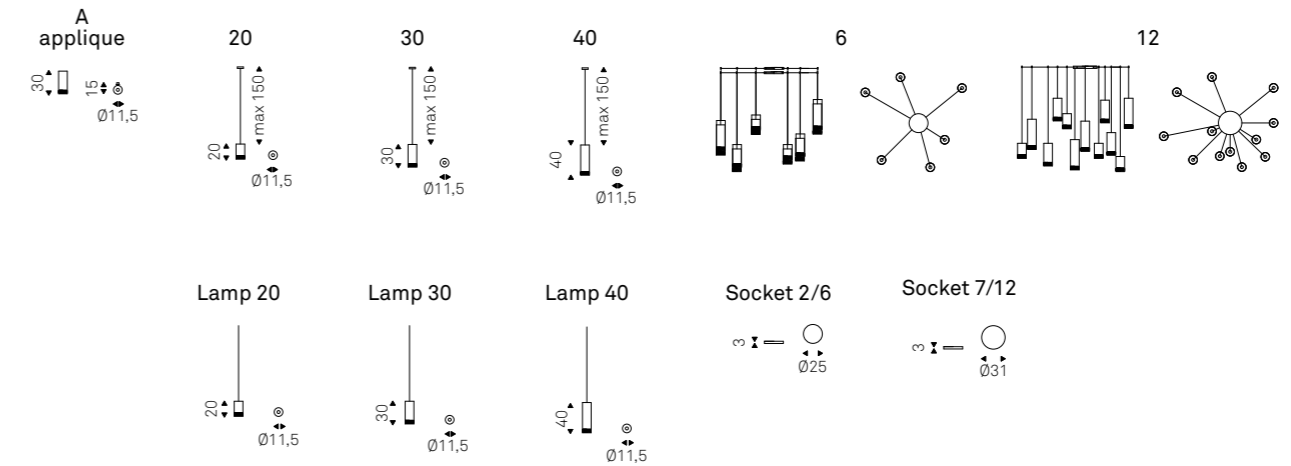

ZOOM - A lamps in black chrome steel

HAVANA

Design **Oriano Favaretto**

Lampada da soffitto con paralume in acciaio verniciato nero opaco e interno in foglia oro. 1: attacco singolo. 2/6: attacco rotondo da 2 a 6 paralumi. 7/12: attacco rotondo da 7 a 12 paralumi. Lampadina non inclusa.

Ceiling lamp with lampshade in mat black steel and internal lampshade in golden foil. 1: single plate. 2/6: round ceiling plate for 2/6 lampshades. 7/12: round ceiling plate for 7/12 lampshades. Bulb not included.

Lampadaire avec diffuseur en acier laqué noir opaque et intérieur en feuille d'or. 1: culot single. 2/6: culot rond de 2/6 abat-jours. 7/12: culot rond de 7/12 abat-jours. Ampoules non comprises.

Lâmpara de tecto con pantalla en acero barnizado negro mate e interior en hoja de oro. 1: soporte de tecto único. 2/6: soporte de tecto redondo para 2/6 pantallas. 7/12: soporte de tecto redondo para 7/12 pantallas. Bombilla no incluida.

Hängelampe mit Lampenschirm aus matt schwarz lackiertem Stahl und Innenschirm aus Blattgold. 1: Einzelne Anschluss. 2/6: Runde Anschluss für 2/6 Lampenschirme. 7/12: Runde Anschluss für 7/12 Lampenschirme. Leuchtmittel nicht enthalten.

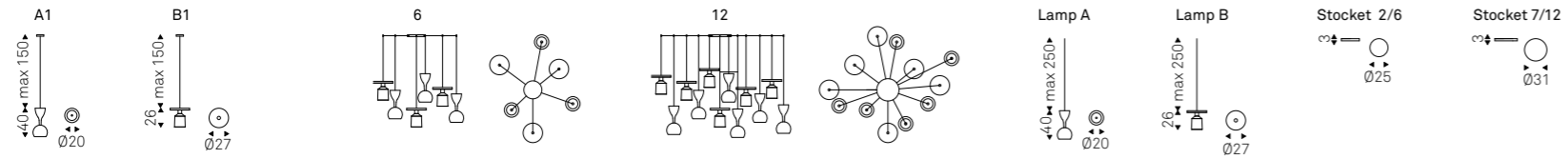

STILO**Design Studio Kronos**

Lampada a soffitto in acciaio verniciato bronzo satinato o cromo nero. 1: attacco singolo. 2/6: attacco rotondo da 2 a 6 paralumi. 7/12: attacco rotondo da 7 a 12 paralumi. Lampadina inclusa.

Ceiling lamp with lampshade in satin bronze steel or black chrome steel. 1: single plate. 2/6: round ceiling plate for 2/6 lampshades. 7/12: round ceiling plate for 7/12 lampshades. Bulb included.

Lampadaire avec abat-jour en bronze satiné ou acier chromé noir. 1: culot single. 2/6: culot rond de 2/6 abat-jours. 7/12: culot rond de 7/12 abat-jours. Ampoules comprises.

Lámpara de techo con pantalla en acero barnizado bronzo satinado o en acero cromo negro. 1: soporte de techo único. 2/6: soporte de techo redondo para 2/6 pantallas. 7/12: soporte de techo redondo para 7/12 pantallas. Bombilla incluida.

Hängelampe aus lackiertem Bronze satiniert oder schwarz verchromtem Stahl. 1: Einzelne Anschluss. 2/6: Runde Anschluss für 2/6 Lampenschirme. 7/12: Runde Anschluss für 7/12 Lampenschirme. Leuchtmittel enthalten.

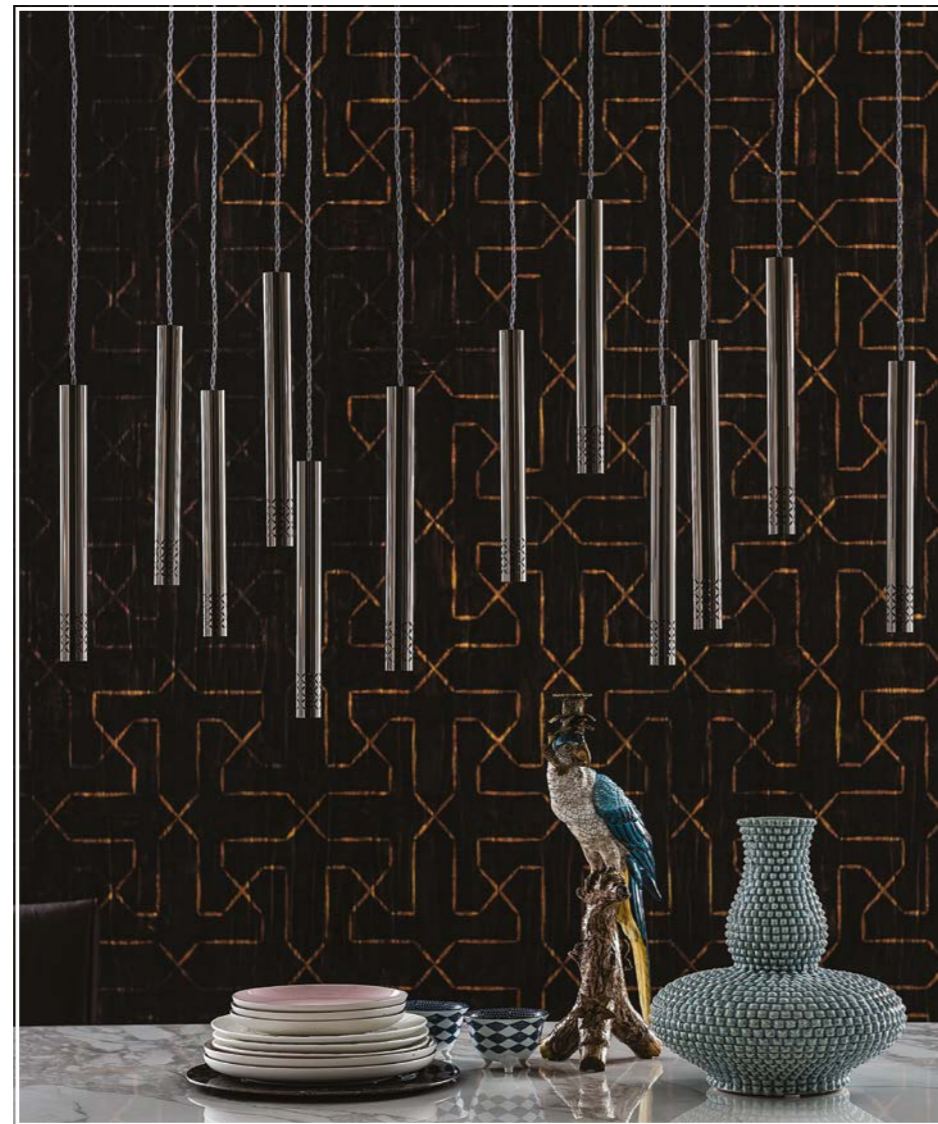
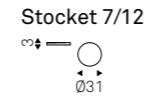
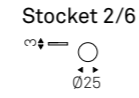
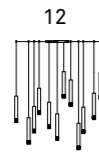
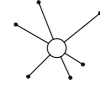
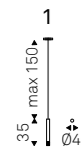



LAMPO A lamp in black finish - YODA KERAMIK table with titanium base and Ardesia ceramic top - ARCADIA chair in soft leather 945 Safari and Canaletto Walnut frame

LAMPO

Design **Paolo Cattelan**

Lampada da terra e da tavolo con struttura in acciaio verniciato gofrato titanio, bianco, nero o graphite. Illuminazione a led, led inclusi.

Floor and table lamp in titanium, white, black or graphite embossed lacquered steel frame. Led lights included.

Lampe de sol ou de table avec structure en acier gaufré titane, blanc, noir ou graphite. Éclairage à led. Led compris.

Lámpara de suelo y sobremesa con estructura en acero barnizado gofrado titanio, blanco, negro o graphite. Iluminación led. Led incluidos.

Boden- oder Tischlampe mit Metallgestell lackiert Titan, weiss, schwarz oder graphite gaufriert. LED Beleuchtung. LED enthalten.

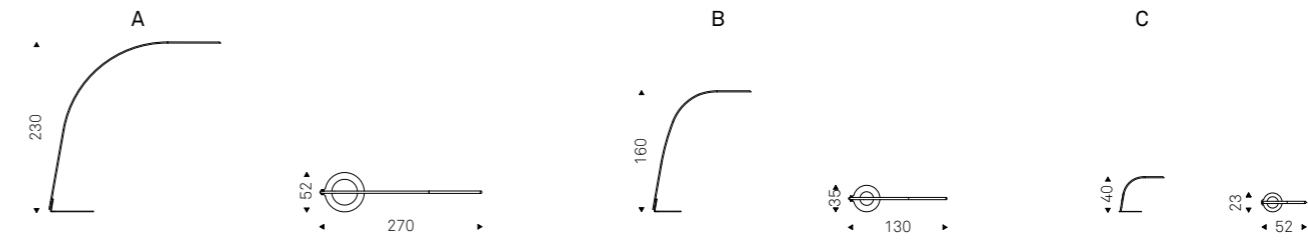

LAMPO B lamp in black finish - EUROPA KERAMIK sideboard in Alabastro ceramic
REGAL mirror in mirrored glass

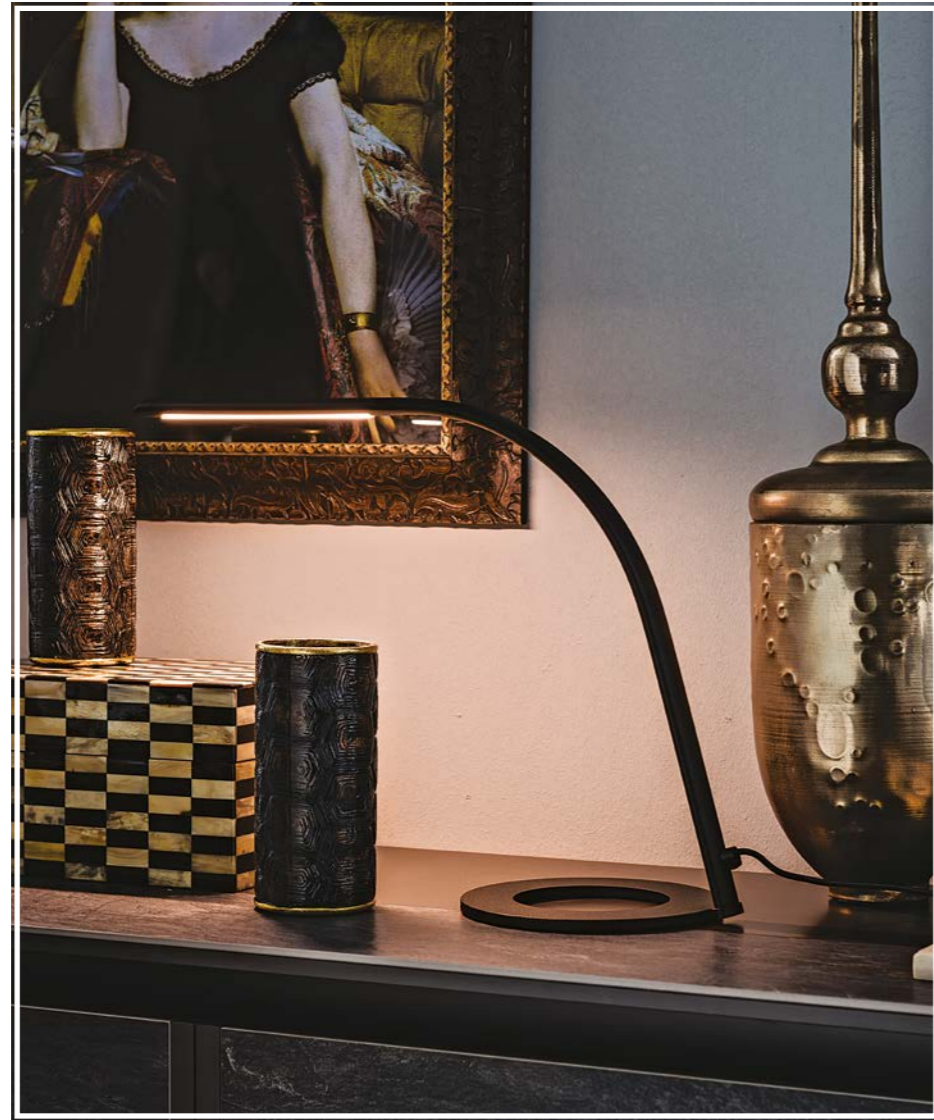

LAMPO C lamp in black finish



LAMPO A lamp in titanium finish - KITANO coffee tables with black base and Ardesia Ceramic top - MAPOON rug

STEALTH

Design **Brogliato Traverso**

Lampada da terra con struttura in acciaio verniciato gofrato titanio, bianco, nero o graphite. Paralume girevole. Illuminazione a led, led inclusi.

Floor lamp in titanium, white, black or graphite embossed lacquered steel. Swivelling lampshade. Led lights included.

Lampe de sol avec structure en acier gaufré titane, blanc, noir ou graphite. Abat jour pivotant. Éclairage à led. Led compris.

Lámpara de suelo con estructura en acero barnizado gofrado titanio, blanco, negro o graphite. Pantalla giratoria. Iluminación led. Led incluidos.

Bodenlampe mit Metallgestell lackiert titan, weiss, schwarz oder graphit gaufriert. Drehbarer Lampenschirm. LED Beleuchtung enthalten.

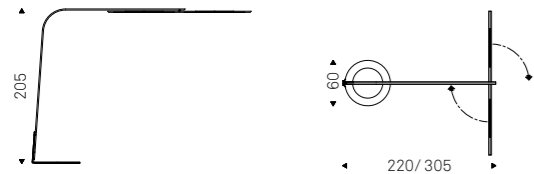

THRILLER

Design **Andrea Lucatello**

Lampada da terra con struttura in acciaio verniciato bianco opaco, grey opaco o gofrato titanio e base nera. Lampadina non inclusa.

Floor lamp with frame in matt white, matt grey or embossed titanium varnished steel and black base. Bulb not included.

Lampe de terre avec structure en acier laqué blanc opaque, grey opaque ou gaufré titane et base noir. Ampoule non comprise.

Lámpara de suelo con estructura en acero barnizado blanco opaco, grey opaco o gofrado titanio y base negra. Bombilla no incluida.

Stehlampe mit Gestell und Schirm aus Edelstahl matt weiß, matt grey oder gaufriert Titan lackiert und Basis schwarz lackiert. Leuchtmittel nicht enthalten.



THRILLER lamp in titanium finish - MUMBAI rug

**THOR**

Design **Oriano Favaretto**

Lampada da terra con struttura in acciaio verniciato bronzo satinato e base in acciaio verniciato nero opaco. Lampadina non inclusa.

Floor lamp with frame in satin bronze steel and matt black painted steel base. Bulb not included.

Lampe de sol avec abat-jour en bronze satiné et base laqué noir opaque. Ampoule non comprise.

Lámpara de suelo con estructura en acero barnizado bronzo satinado y base en acero barnizado negro mate. Bombilla no incluida.

Stehlampe mit Gestell in Stahl lackiert Bronze satiniert und Basis in Stahl lackiert schwarz matt. Leuchtmittel nicht enthalten.



PIXEL**Design Paolo Cattelan**

Porta TV con supporto orientabile di 15°, base verniciata gofrato bianco o nero e anta a ribalta. Portata massima per TV kg 50. Predisposto attacco Vesa 75, 100, 200, 300 e 400.

TV stand with 15° adjustable support, embossed white or black painted base and flap door. TV Max capacity: 50 kg. Pre-arranged for Vesa fitting 75, 100, 200, 300 and 400.

Meuble porte-TV avec support orientable de 15°, base gaufré blanc ou noir et porte à abattant. Capacité maximum pour TV : Kg 50. Prédiposition Vesa 75, 100, 200, 300 et 400.

Mueble TV con soporte orientable de 15°, base barnizada gofrado blanco, o negro y puerta abatible. Peso máximo para TV kg 50. Predisuesto soporte VESA 75, 100, 200, 300 y 400.

TV-Träger um 15° verstellbar, Basis lackiert weiß gaufriert oder schwarz und Klapptüre. Maximale Belastbarkeit kg 50. Für Anschluss VESA 75, 100, 200, 300 und 400 vorbereitet.

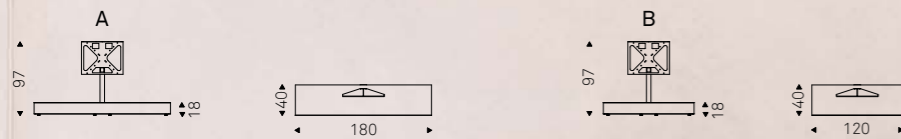

MUMBAI - RADJA

Design **STC Studio**

Tappeto tessuto in cotone e
ciniglia a rilievo.

Rug made in cotton and
chenille with relief.

Tapis en tissu de coton et
chenille.

Alfombra en tejido de
algodón y felpa.

Teppich aus Baumwolle und
Chenille mit Relief Struktur.

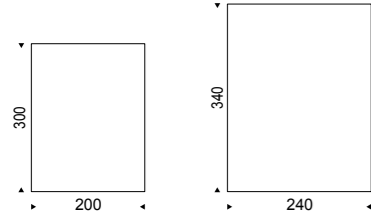

RADJA



MUMBAI



**BRANDY****Design Studio Kronos**

Carrello bar con struttura in acciaio verniciato gofrato graphite e piani in legno noce Canaletto o rovere bruciato.

Trolley bar with frame in graphite embossed lacquered steel and tops in Canaletto walnut or burned oak wood.

Chariot-bar avec structure en acier gaufré graphite et plateau en bois noyer Canaletto ou rouvre brulé.

Carrito con estructura en acero barnizado gofrado graphite y estantes en madera nogal Canaletto o roble ahumado.

Bar-Wagen mit Gestell in Stahl lackiert gaufriert graphit und Holzplatten in Nussbaum Canaletto oder "verbrannte Eiche".

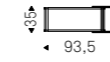
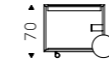

NELSON**Design Andrea Lucatello**

Letto con struttura in legno noce Canaletto o rovere bruciato. Testiera interamente rivestita in tessuto, synthetic nubuck, micro nubuck, ecopelle o pelle nei colori come da campionario. Rete inclusa.

Bed with Canaletto walnut or burned oak frame. Headboard completely covered in fabric, synthetic nubuck, micro nubuck, synthetic leather or soft leather as per sample card. Slats included.

Lit avec structure en noyer Canaletto ou rouvre brûlé. Tête de lit complètement revêtue en tissu, synthetic nubuck, micro nubuck, simili-cuir ou cuir mince selon échantillons. Sommier comprise.

Cama con estructura en madera nogal Canaletto o roble ahumado. Cabecera completamente tapizada en tejido, synthetic nubuck, micro nubuck, ecopiel o piel según muestrario. Somier incluido.

Bett mit Gestell in Nussbaum Canaletto oder "verbrannte Eiche". Kopfteil komplett bezogen in Stoff-, synthetic nubuck, micro nubuck, Kunstleder oder Softleder laut Musterkarte. Lattenrost inklusive.

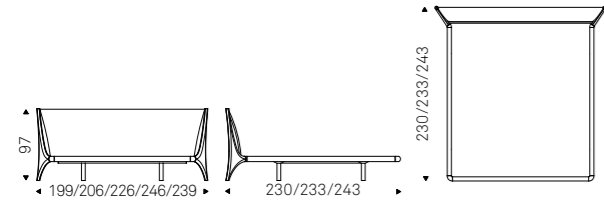



**EDWARD****Design Gino Carollo**

Letto interamente rivestito in tessuto, synthetic nubuck, micro nubuck, ecopelle o pelle nei colori come da campionario. Profilo testiera in noce Canaletto o rovere bruciato. Rete inclusa. Optional: rete alzabile con vano contenitore.

Upholstered bed covered in fabric, synthetic nubuck, micro nubuck, synthetic leather or soft leather as per sample card. Headboard profiles in Canaletto walnut or burned oak. Slats included. Optional: pull-up slats with container.

Lit complètement revêtu en tissu, synthetic nubuck, micro nubuck, simili cuir ou cuir mince selon échantillons. Profil de la tête du lit en noyer Canaletto ou rovre brûlé. Sommier comprise. Option: sommier relevable pour utilisation du caisson de rangement.

Cama totalmente revestida en tejido, synthetic nubuck, micro nubuck, ecopiel o piel según muestrario. Perfil cabecera en nogal Canaletto o roble ahumado. Somier incluido. Opcional: somier levantable con contenedor.

Gepolstertes Bett mit Bezug in Stoff-, synthetic nubuck, micro nubuck, Kunstleder oder Softleder laut Musterkarte. Kopfteilprofil aus Nussbaum Canaletto oder "verbrannte Eiche". Lattenrost inklusive. Option: Bettkasten.

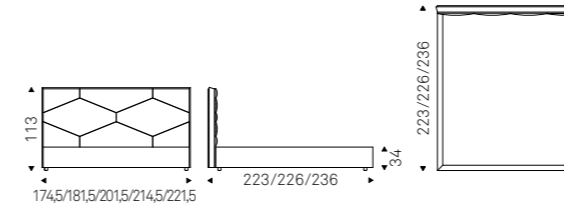



EDWARD bed in soft leather 948 Lino and burned oak - HUDSON bookcases with black frame and burned oak shelves - BOLERO C lamp
 CIRO nightstands with oyster frame and soft leather 953 Ardesia inserts



EDWARD bed in soft leather 043 Moka and burned oak - HUDSON bookcases with black frame and burned oak shelves
 KARIBU lamp in black finish - KUBO pouf in leather 71 Bianco

LUDOVIC

Design **Manzoni & Tapinassi**

Letto imbottito rivestito in ecopelle, tessuto, synthetic nubuck, micro nubuck, o pelle come da campionario. Piedi in acciaio verniciato bronzo opaco, gofrato bianco o graphite. Optional: retro testiera rivestita in pelle. Rete inclusa.

Upholstered bed covered in synthetic leather, fabric, synthetic nubuck, micro nubuck, or soft leather as per sample card. With matt bronze, white or graphite embossed lacquered steel feet. Optional: back headboard covered in soft leather. Slats included.

Lit rembourré et revêtu en simili cuir, tissu, synthetic nubuck, micro nubuck, ou cuir mince selon échantillons. Pieds en acier laqué bronze opaque, gaufré blanc ou graphite. Optional: dos de tête de lit revêtu en cuir mince. Sommier compris.

Cama tapizada revestida en tejido, ecopiel, synthetic nubuck, micro nubuck, o piel según muestrario. Patas en acero barnizado bronce mate, gofrado blanco o graphite. Opcional: retro cabecera revestida en piel. Somier incluido.

Gepolstertes Bett mit Bezug aus Stoff-, synthetic Nubuck, micro Nubuck, Kunstleder oder Softleder laut Musterkarte. Beine aus Stahl lackiert matt bronze, weiss oder graphit gaufriert. Option: Rückseite des Kopfteils mit Softlederbezug. Lattenrost inklusive.

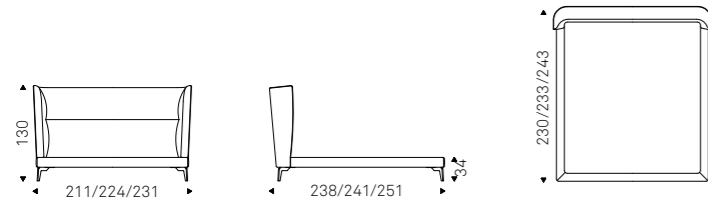



LUDOVIC bed in micronubuk MN604 shadow - STING side tables with Catalatta ceramic top - ASIA lamps in white and bronze finish
 RADJA rugs - JANEIRO MAGNUM mirror in burned oak

AMADEUS**Design Manzoni & Tapinassi**

Letto imbottito rivestito in ecopelle o pelle come da campionario. Piedi in acciaio verniciato bronzo opaco, gofrato bianco o graphite. Optional: retro testiera rivestita in pelle. Rete inclusa.

Upholstered bed covered in synthetic leather or soft leather as per sample card. With matt bronze, white or graphite embossed lacquered steel feet. Optional: back headboard covered in soft leather. Slats included.

Lit rembourré et revêtu en simili cuir ou cuir mince selon échantillons. Pieds en acier laqué bronze opaque, gaufré blanc ou graphite. Optional: dos de tête de lit revêtu en cuir mince. Sommier comprise.

Cama embutida revestida en tejido, ecopiel o piel según muestrario. Patas en acero barnizado bronce mate, gofrado blanco o graphite. Opcional: retro cabecera revestida en piel. Somier incluido.

Gepolstertes Bett Kunstlederbezug oder Softlederbezug laut Musterkarte. Beine aus Stahl lackiert matt Bronze, weiss oder graphit gaufriert. Option: Rückseite des Kopfteil Softlederbezug oder bezug. Lattenrost inklusive.

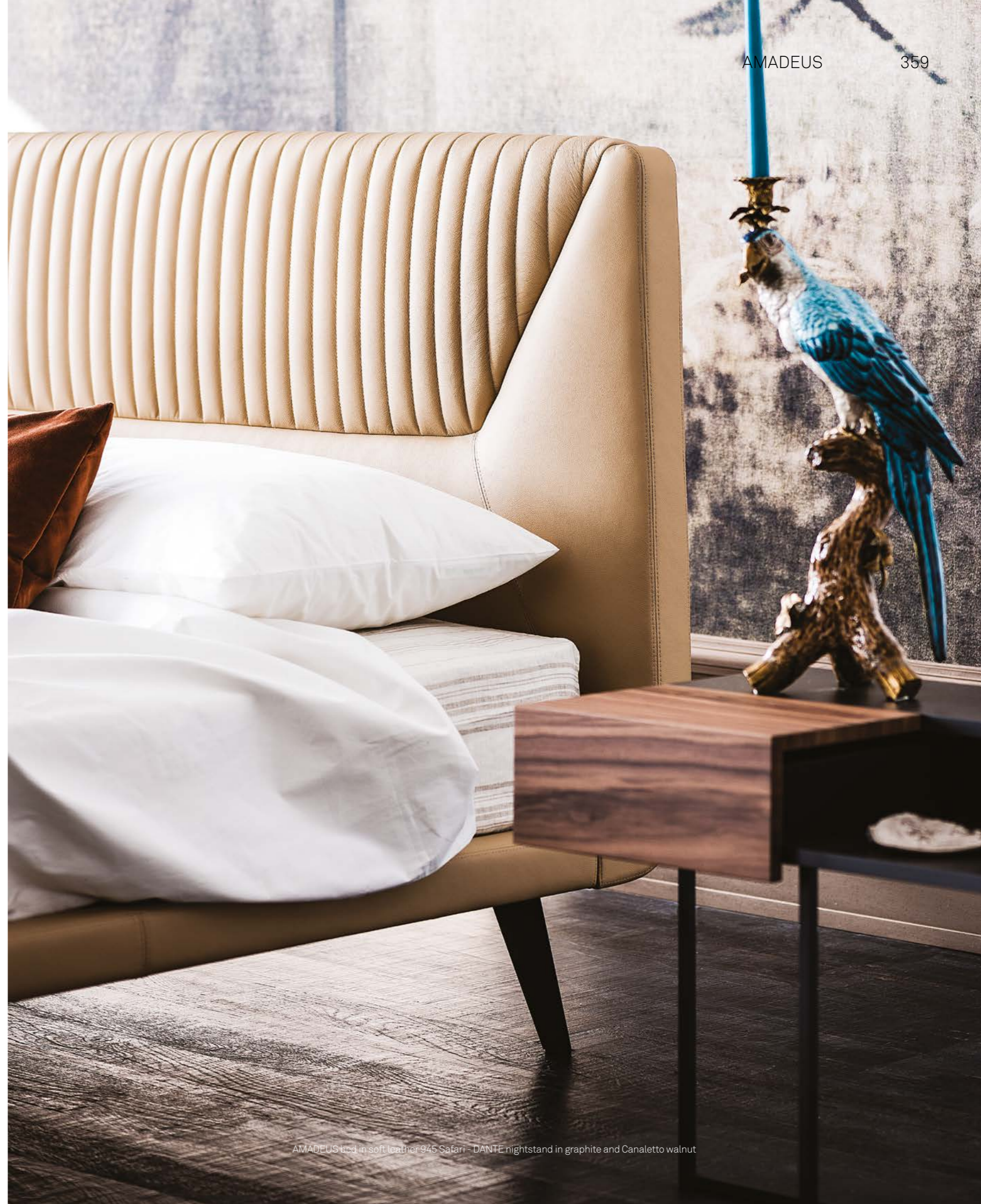
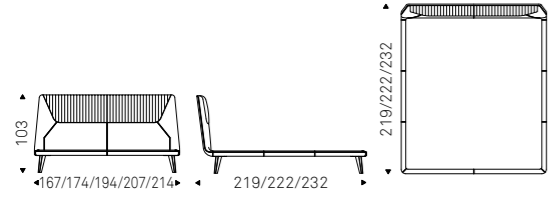



AMADEUS bed in soft leather 945 Safari - DANTE nightstand in graphite and Canaletto walnut



CIRO 52BL nightstands with oyster frame and soft leather 953 Ardesia inserts

**CIRO****Design Paolo Cattelan**

Comodino in due dimensioni e due altezze a 2 cassetti, comò a 4/8 cassetti con struttura e frontali in legno goffrato graphite, oyster o in noce Canaletto o rovere bruciato. Inserti in ecopelle o pelle come da campionario. Versione A con base in acciaio verniciato goffrato graphite.

Nightstand in two sizes and two heights with 2 drawers, dresser with 4/8 drawers with frame and fronts in graphite or oyster embossed lacquered wood, or Canaletto walnut or burnt oak. Inserts in synthetic leather or soft leather as per our sample cards. A Version with graphite embossed lacquered steel base.

Table de nuit en deux dimensions et deux hauteurs à 2 tiroirs, commode à 4/8 tiroirs avec structure et tiroirs en bois gaufré graphite, oyster ou en noyer Canaletto ou rovere brûlé. Détails en simili cuir ou cuir mince selon échantillons. Version A avec base en acier gaufré graphite.

Mesa de noche en dos medidas y dos alturas con 2 cajones, cómoda con 4/8 cajones con estructura y frontales en madera barnizada gofrado graphite, oyster o nogal Canaletto o roble ahumado. Detalles en ecopiel o piel según muestrario. Version A con base en acero barnizado gofrado graphite.

Nachttisch in zwei verschiedene Größen mit 2 Schubladen oder Kommoden mit 4/8 Schubladen. Holzstruktur und Schubladenfronten aus Nussbaum Canaletto, "verbrannte Eiche" oder lackiert oyster oder graphit gaufriert. Kunstleder oder Softledereinsätze laut Musterkarte. Version A mit Basis aus Stahl lackiert graphite gaufriert.

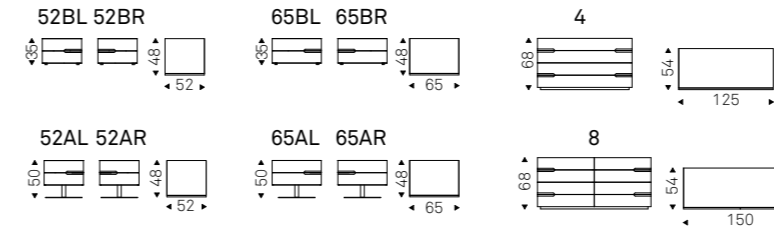

CIRO 65AL nightstand with graphite frame and soft leather 948 Lino insets

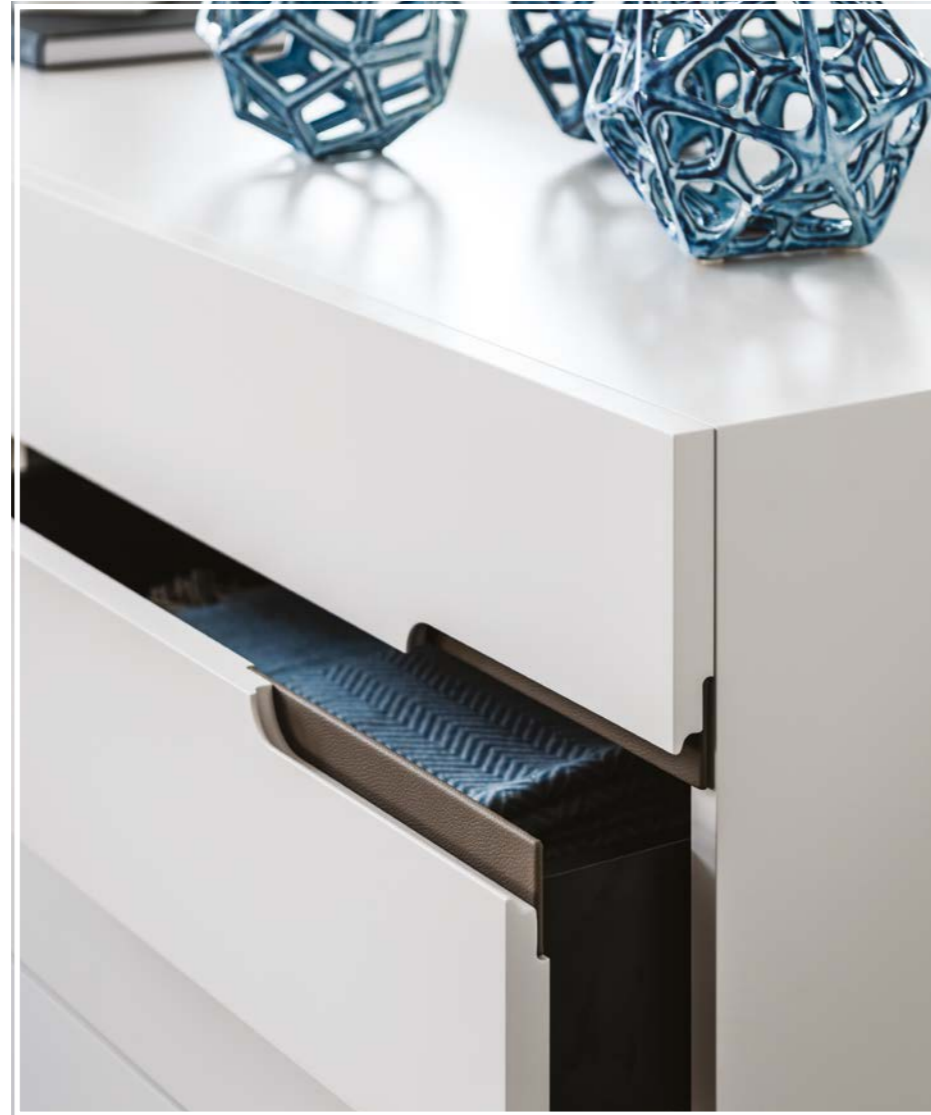

CIRO 8 chest with oyster frame and soft leather 953 Ardesia inserts - SAMIR mirror 120x120 - KARIBU lamp in black finish - DARWIN rug

**DANTE**

Design Andrea Lucatello
Comodino con struttura verniciata gofrato graphite o bianco con anta scorrevole in legno noce Canaletto o rovere bruciato. Base in acciaio verniciato gofrato graphite o bianco.

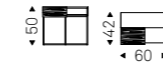

Nightstand in white or graphite embossed lacquered wood with sliding door in Canaletto walnut or burned oak. Base in white or graphite embossed lacquered steel.

Table de nuit avec structure en bois gaufré blanc ou graphite avec porte coulissante en noyer Canaletto ou roivre brulé. Base en acier gaufré blanc ou graphite.

Mesa de noche en madera barnizada gofrado blanco o graphite y puerta corredera en nogal Canaletto o roble ahumado. Base en acero barnizado gofrado blanco o graphite.

Nachttisch mit Gestell aus Holz lackiert weiss oder graphite gaufriert. Schiebetür aus Nussbaum Canaletto oder "verbrannte Eiche". Basis aus Stahl lackiert weiss oder graphite gaufriert.



6/7
COLLECTION

cattelan
italia

CATTELANITALIA.COM



CATTELAN ITALIA SPA - via pilastri 19 - 36010 Carrè / Vicenza - Italy
phone +39 0445 318711 - fax +39 0445 314289 - email: info@cattelanitalia.com