

**cattelan
italia**

PLANER KER-WOOD SKORPIO KER-WOOD

**ISTRUZIONI DI MONTAGGIO ASSEMBLING INSTRUCTIONS MONTAGEANLEITUNG
INSTRUCCIONES DE MONTAJE INSTRUCCIONES DE MONTAJE**

Cattelan Italia spa si riserva di apportare, senza preavviso, modifiche nei materiali, nei rivestimenti, nelle finiture e nei disegni dei prodotti presentati in questo catalogo. Le textures ed i colori dei materiali e delle finiture hanno valore indicativo in quanto soggetti alle tolleranze dei processi di stampa.

Cattelan Italia spa reserves the right to change, without previous notice, materials, covers, finishes and drawings of the products presented in this catalogue. The textures and colours of materials and finishes are indicative as they are depending on the tolerances of the printing process.

Cattelan Italia spa behaltet sich vor, ohne Vorankündigung, Veränderungen an den Materialien, Bezügen, Finish und Zeichnungen der in diesem Katalog vorgestellten Produkte vorzunehmen. Die Texturen und Farben der Materialien und Finish haben einen hinweisenden Wert, da sie von den Toleranzen im Druckprozess abhängig sind.

Cattelan Italia spa se réserve le droit d'apporter, sans préavis, des modifications au niveau des matériaux, des revêtements, des finitions et du design des produits présentés dans ce catalogue. Les textures et les couleurs des matériaux et des finitions sont une valeur indicative parce-que ils changent selon la tolérance aux procédés d'imprimerie.

Cattelan Italia spa se reserva el derecho de aportar modificaciones de dibujo, materiales, acabados y tapicerías, sin que esté obligada a dar aviso anticipado. Las textures y los colores de los materiales y de los acabados tienen solo un valor indicativo porque están sujetos a la tolerancia en los procesos de imprenta.

IMPORTANTE: Riporre per eventuali consultazioni future!!!!

IMPORTANT: File for future consultation!!!!

WICHTIG: Bitte aufbewahren für eventuelle spätere Nachfragen!!!!

IMPORTANT: A conserver pour les futurs besoins de référence!!!!

¡IMPORTANTE: Guardar para consultas posteriores!

PLANER KER-WOOD

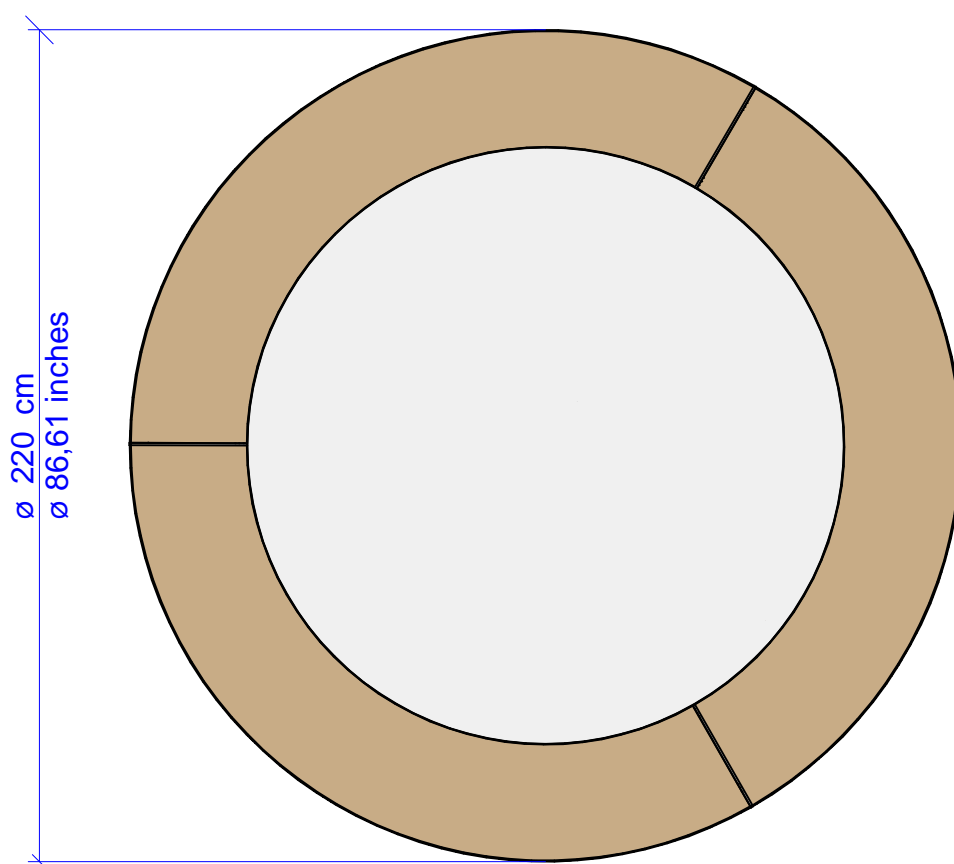
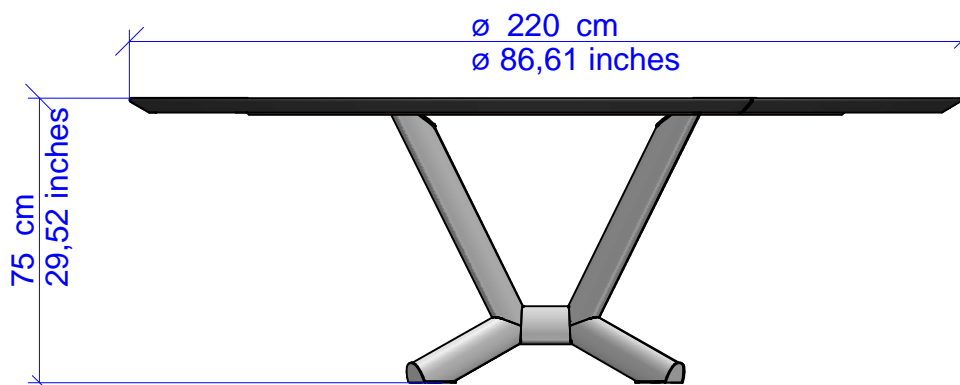

n° 06 spina Legno \varnothing 12x50.

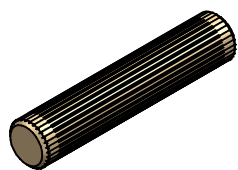

n° 12 art. 1056.

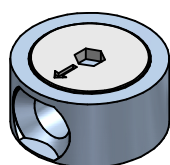

n° 06 cod. 216018600335.

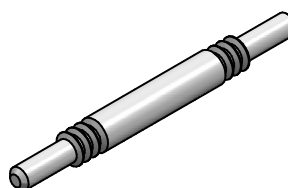

n° 10 15x15 sp.1 TRSP.

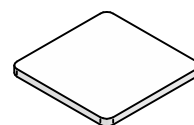

n° 04 feltro \varnothing 50 sp.5 mm.

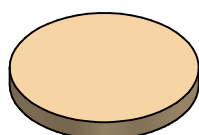

n° 04 velcro sagomato.



n° 04 velcro 80x100 N.

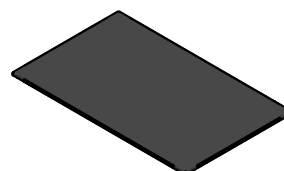

n° 01 da 06.

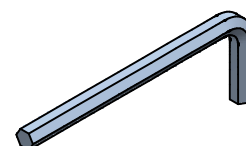

SKORPIO KER-WOOD

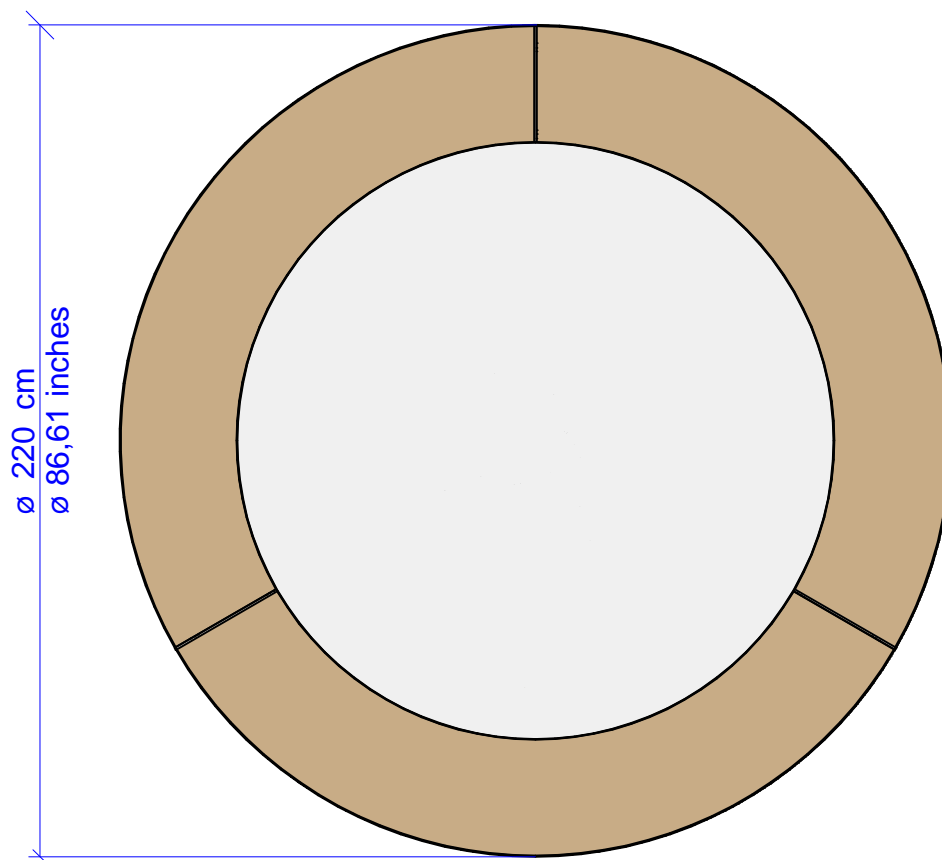
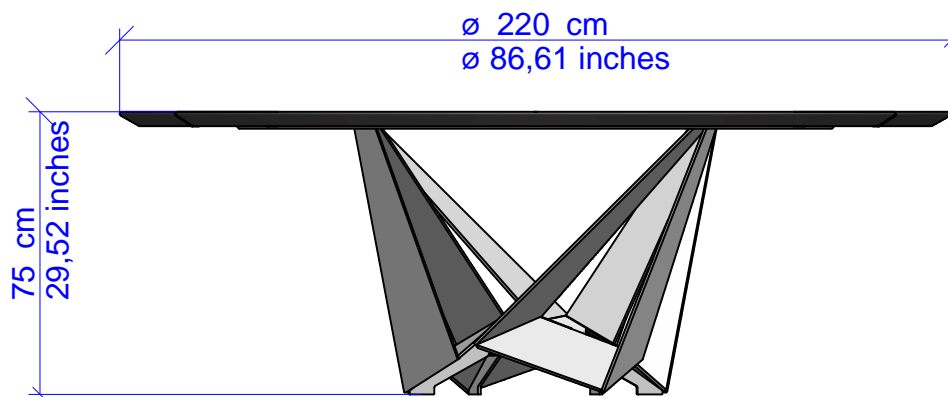

n° 06 spina Legno \varnothing 12x50.

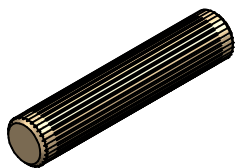

n° 12 art. 1056.

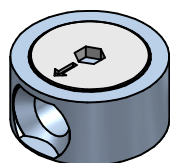

n° 06 cod. 216018600335.

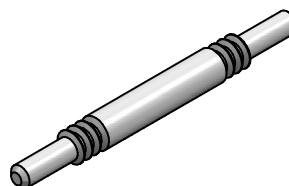

n° 10 15x15 sp.1 TRSP.

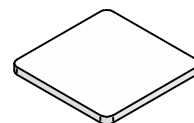

n° 04 feltro \varnothing 50 sp.5 mm.



n° 08 TC croce 3,5x20 N.



n° 04 pz.



n° 01 da 06.

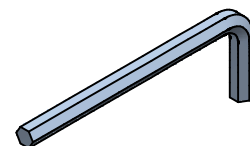

ø220 cm - ø86,61 inches

Data
24/07/2018

N° pagina
05 di 12

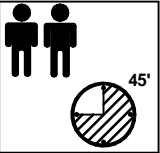

1 PLANER

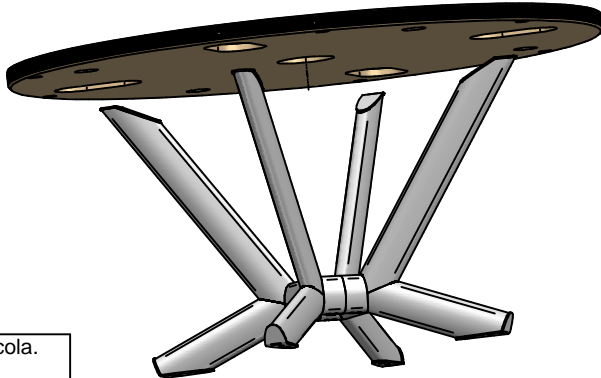

n° 04 foglio pellicola.

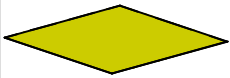

n° 04 velcro 80x100 N.

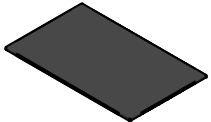

n° 04 velcro sagomato.

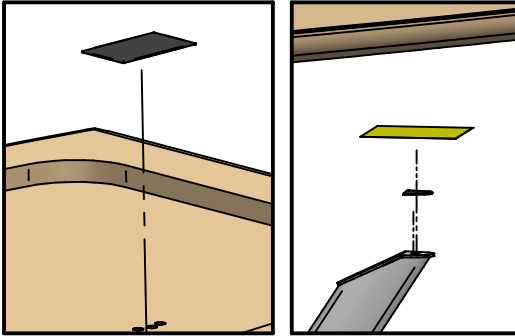

**CENTRARE IL PIANO
CENTER THE TOP**

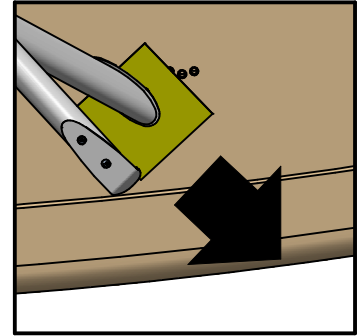

**ATTENZIONE: LA LASTRA IN CERAMICA É SOLO BLOCCATA SUL PANNELLO NON É FISSATA!!!!
NON TOGLIERLA ASSOLUTAMENTE DAL PIANO!!!!
MANEGGIARE CON LA MASSIMA CAUTELA!!!!**

**ATTENTION: THE CERAMIC SLAB IS STUCK TO A WOODEN PANEL. IT ISN'T FIXED!!!!
DON'T SEPARATE THE CERAMIC SLAB FROM THE WOODEN PANEL!!!!**

PLEASE HANDLE THE CERAMIC TOP WITH EXTREME CAUTION!!!!

**ATTENZIONE!!!! - ATTENTION!!!!
ACHTUNG!!!! - ATTENTION!!!!
¡ATENCIÓN!**



1 SKORPIO

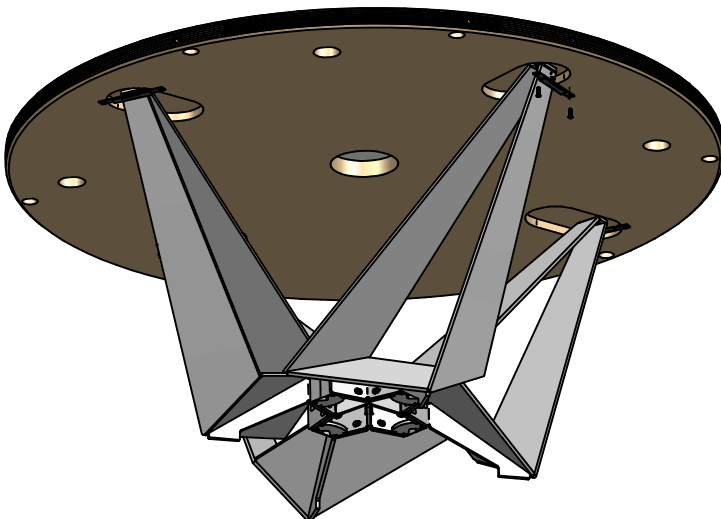

n° 04 pz.

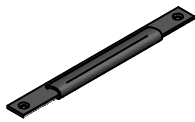

n° 08 TC croce 3.5x20 N.

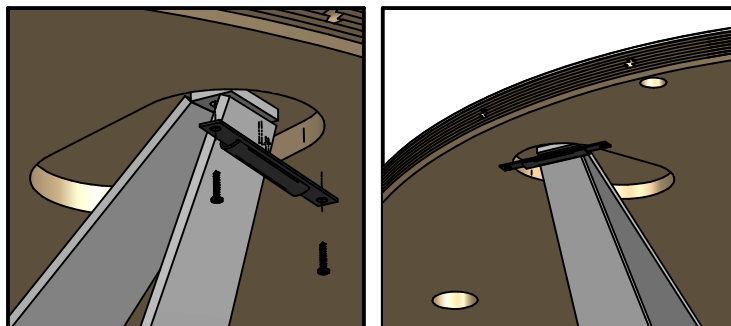

**ATTENZIONE: LA LASTRA IN CERAMICA É SOLO BLOCCATA SUL PANNELLO NON É FISSATA!!!!
NON TOGLIERLA ASSOLUTAMENTE DAL PIANO!!!!
MANEGGIARE CON LA MASSIMA CAUTELA!!!!**

**ATTENTION: THE CERAMIC SLAB IS STUCK TO A WOODEN PANEL. IT ISN'T FIXED!!!!
DON'T SEPARATE THE CERAMIC SLAB FROM THE WOODEN PANEL!!!!**

PLEASE HANDLE THE CERAMIC TOP WITH EXTREME CAUTION!!!!

Posizionare il pezzo in appoggio alla parte.

Place the piece resting on the side.

Legen Sie das Stück auf der Seite.

Coloque la pieza de descanso en el lateral.

Mettez le morceau se penchant sur le côté.

**ATTENZIONE!!!! - ATTENTION!!!!
ACHTUNG!!!! - ATTENTION!!!!
¡ATENCIÓN!**



ø220 cm - ø86,61 inches

Data
23/07/2018

N° pagina
06 di 12

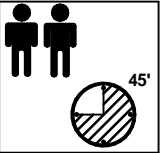

2

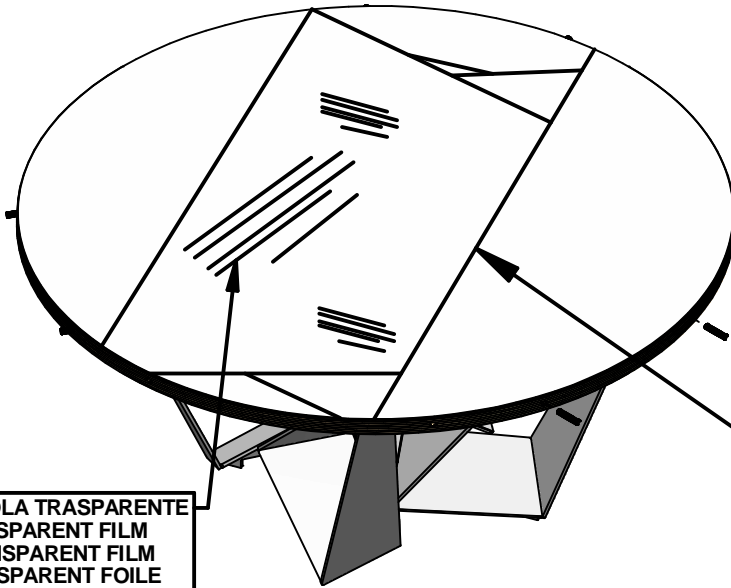

PELLICOLA TRASPARENTE
TRASPARENT FILM
TRANSPARENT FILM
TRANSPARENT FOILE
PELICULA TRASPARENTE

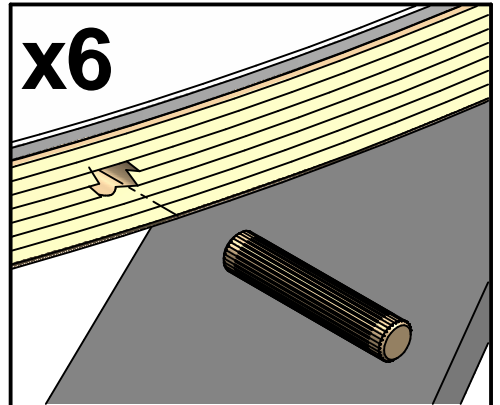

x6

**IMPORTANTE!!!!
VERY IMPORTANT!!!!
WICHTIG!!!!
TRÈS IMPORTANT!!!!
¡MUY IMPORTANTE!**



**TOGLIERE LA PELLICOLA TRASPARENTE
DOPO AVER ESEGUITO IL MONTAGGIO
SULLA BASE.**

**REMOVE THE TRASPARENT FILM AFTER
THE ASSEMBLING THE BASE.**

**ATTENZIONE!!!! - ATTENTION!!!!
ACHTUNG!!!! - ATTENTION!!!!
¡ATENCIÓN!**

**ATTENZIONE: LA LASTRA IN
CERAMICA È SOLO BLOCCATA
SUL PANNELLO NON È
FISSATA!!!!**

**ATTENTION: THE CERAMIC
SLAB IS STUCK TO A WOODEN
PANEL. IT ISN'T FIXED!!!!**



n° 06 spina Legno ø12x50.

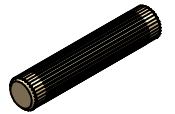

3

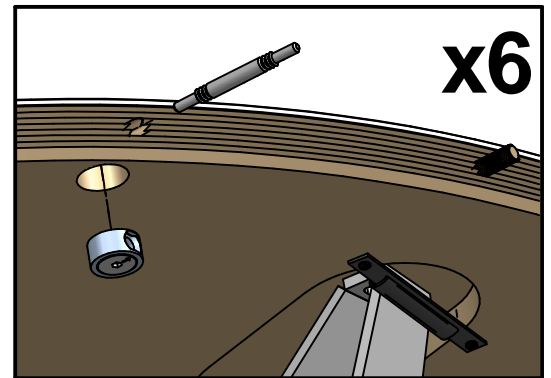
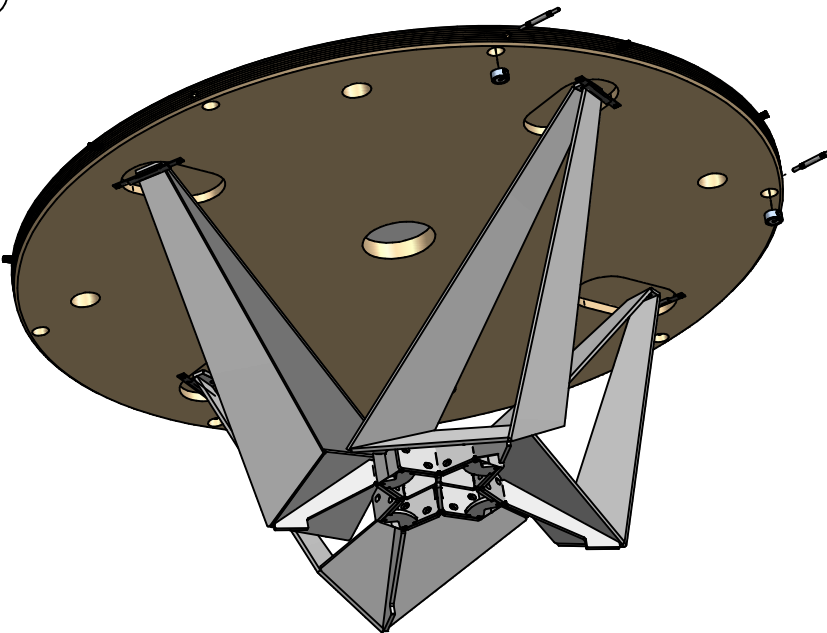

x6

**ATTENZIONE!!!! - ATTENTION!!!!
ACHTUNG!!!! - ATTENTION!!!!
¡ATENCIÓN!**

**ATTENZIONE: LA LASTRA IN
CERAMICA È SOLO BLOCCATA
SUL PANNELLO NON È
FISSATA!!!!**

**ATTENTION: THE CERAMIC
SLAB IS STUCK TO A WOODEN
PANEL. IT ISN'T FIXED!!!!**



n° 06 art. 1056.



n° 06 cod. 216018600335.

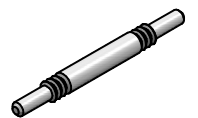

n° 01 da 06.



ø220 cm - ø86,61 inches

4

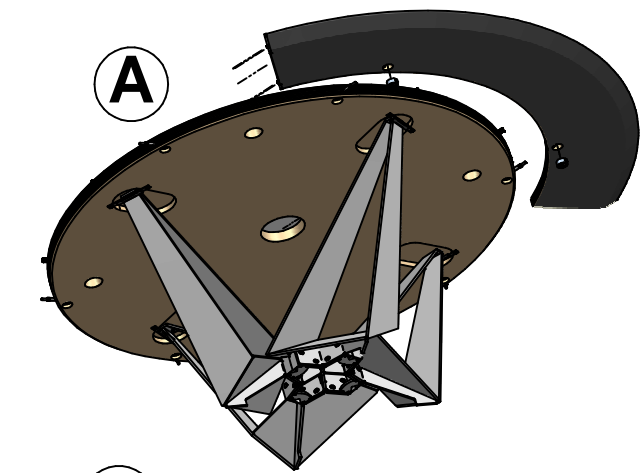

A

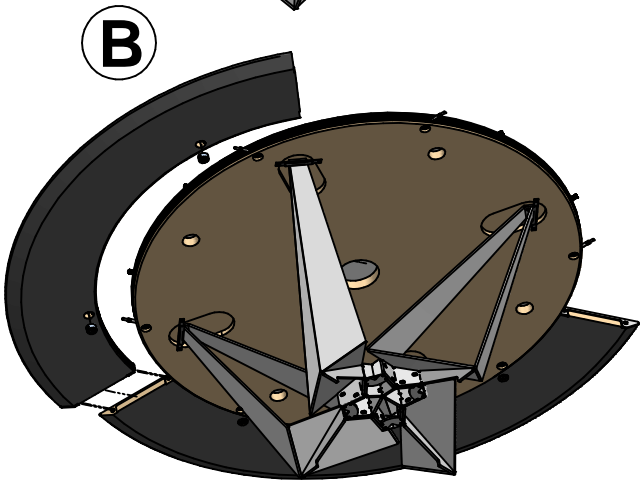
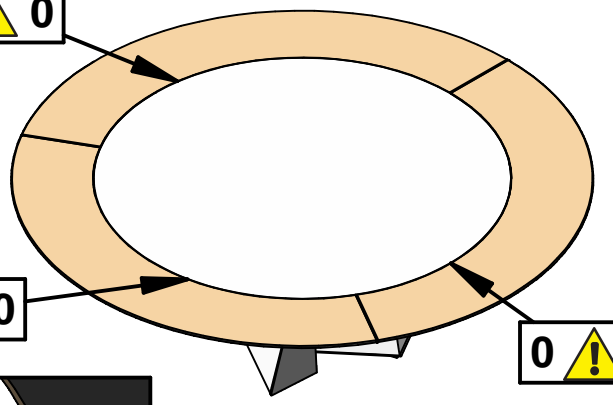
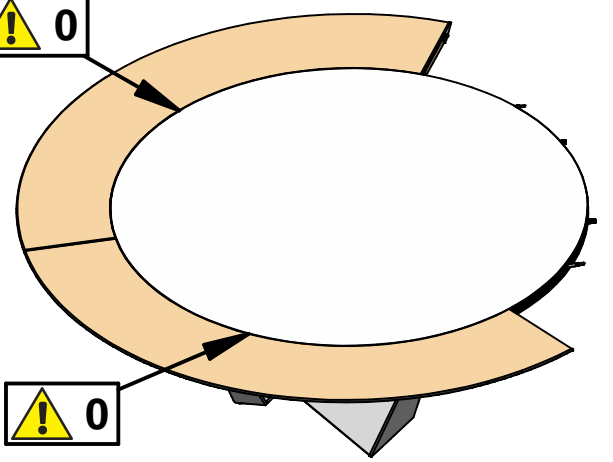
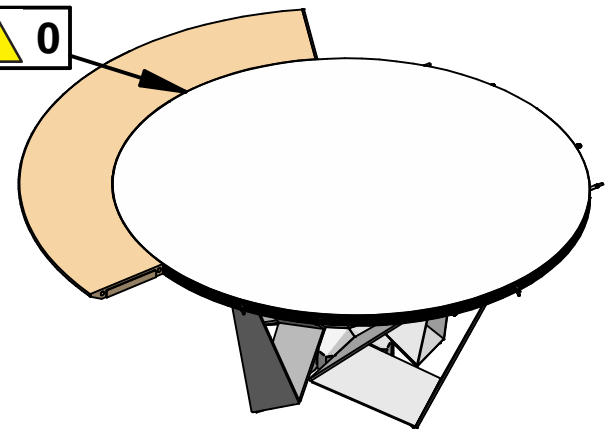

B

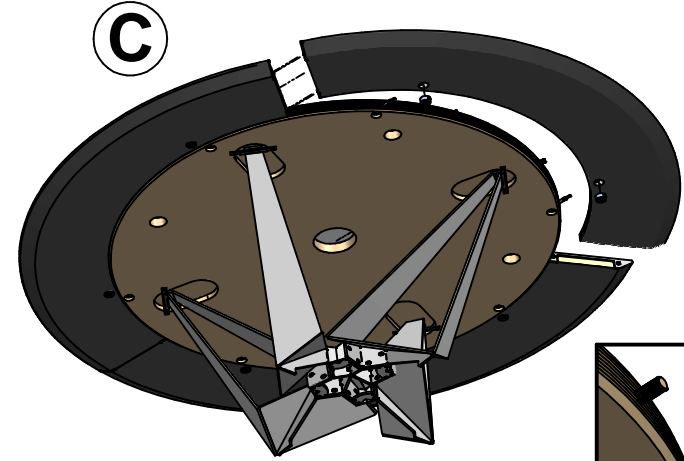

C

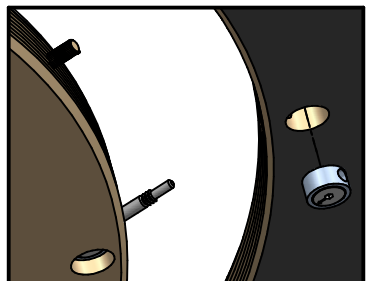

ATTENZIONE!!!! - ATTENTION!!!!!
ACHTUNG!!!! - ATTENTION!!!!!
¡ATENCIÓN!

ATTENZIONE: LA LASTRA IN CERAMICA É SOLO BLOCCATA SUL PANNELLO NON É FISSATA!!!!!
NON TOGLIERLA ASSOLUTAMENTE DAL PIANO!!!!!
MANEGGIARE CON LA MASSIMA CAUTELA!!!!!

ATTENTION: THE CERAMIC SLAB IS STUCK TO A WOODEN PANEL. IT ISN'T FIXED!!!!!
DON'T SEPARATE THE CERAMIC SLAB FROM THE WOODEN PANEL!!!!!
PLEASE HANDLE THE CERAMIC TOP WITH EXTREME CAUTION!!!!!

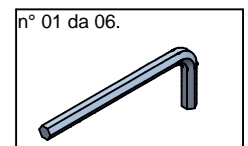
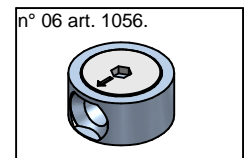

Ø220 cm - Ø86,61 inches

5

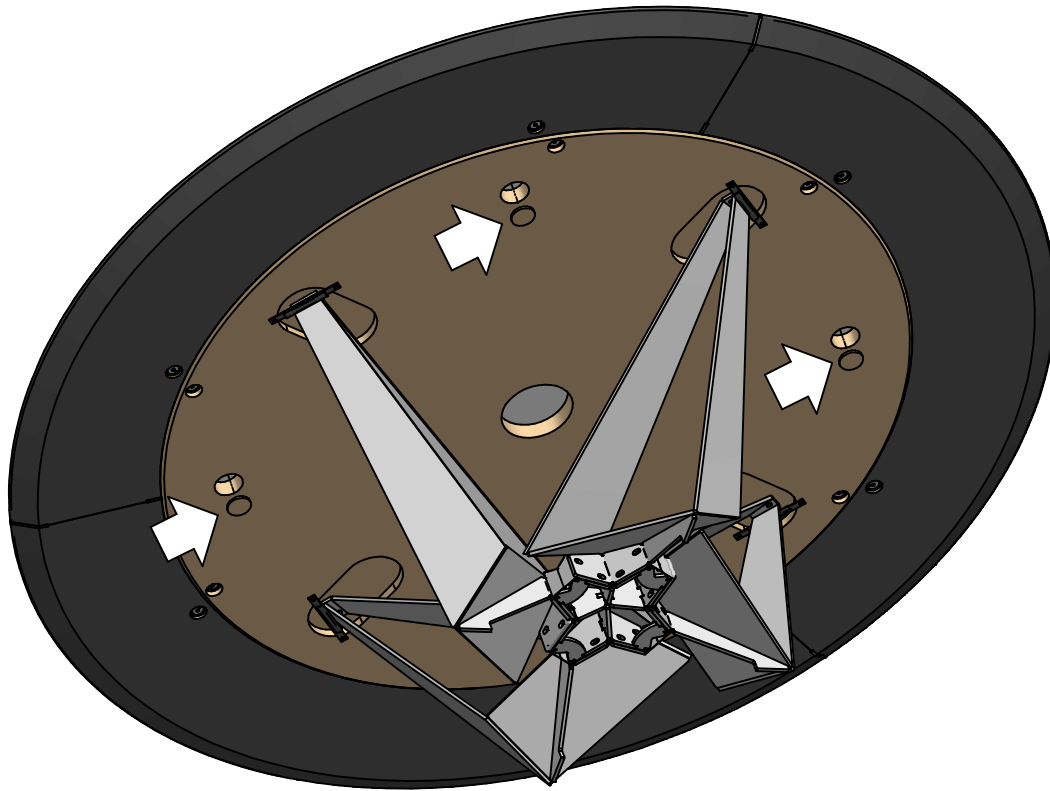

Per bloccare il piano in ceramica
posizionare i feltri in dotazione
come indicato graficamente.

To keep in position the ceramic top,
place the provided rubber bumpers
as shown.

Pour bloquer le plateau en
céramique, placer les feutres fournis
comme indiqué graphiquement.

Para fijar el sobre de cerámica
posicionar los feltros en dotación
según indicaciones gráficas.

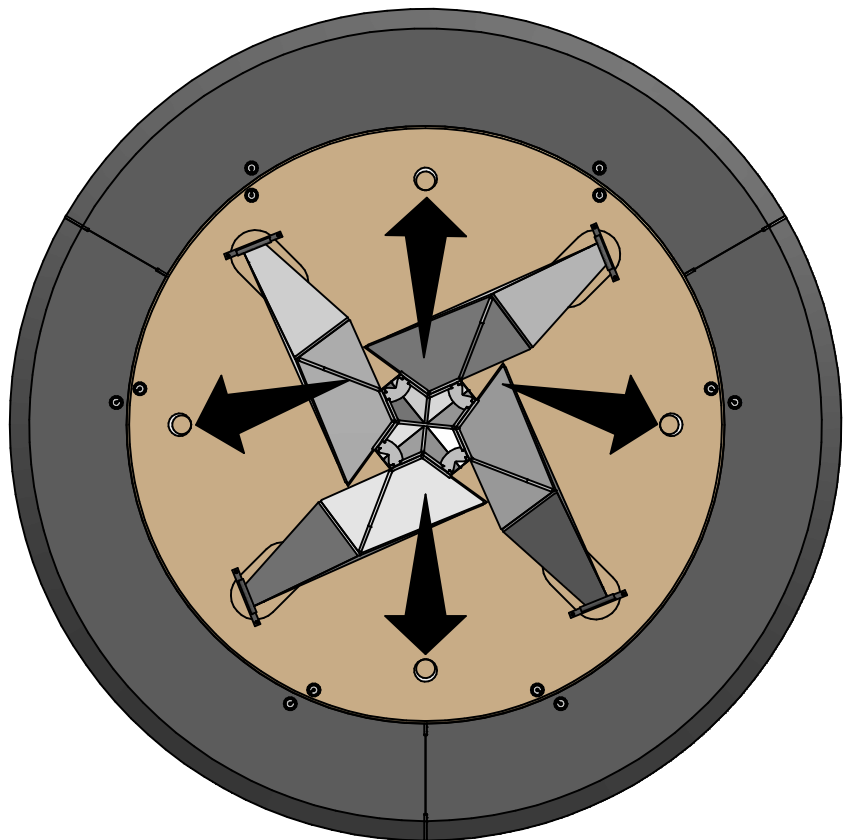

IMPORTANTE!!!!
VERY IMPORTANT!!!!
WICHTIG!!!!
TRÈS IMPORTANT!!!!
¡MUY IMPORTANTE!

<p>Per livellare il piano in ceramica. To level the ceramic top. Die Parteien zu nivellieren. Pour niveler le dessus en céramique. Para nivelar la parte superior de cerámica</p>	<p>n° 10 15x15 sp.1 mm TRSP.</p>	<p>n° 04 feltro ø50 sp.5 mm.</p>
---	----------------------------------	----------------------------------

IMPORTANTE: Riporre per eventuali consultazioni future!!!!

IMPORTANT: File for future consultation!!!!

WICHTIG: Bitte aufbewahren für eventuelle spätere Nachfragen!!!!

IMPORTANT: A conserver pour les futurs besoins de reference!!!!

¡IMPORTANTE: Guardar para consultas posteriores!



USO

Il prodotto é destinato per l'utilizzo all'interno delle abitazioni con l'uso per il quale é stato realizzato.



REALIZZAZIONE

Piccole irregolarità sulla base sono dovute alla lavorazione manuale del prodotto.



MANUTENZIONE

Non vanno assolutamente utilizzati strumenti metallici appuntiti o panni abrasivi per eliminare eventuali residui di sporco presenti sulla superficie del prodotto, in quanto possono danneggiare la superficie stessa. Non vanno assolutamente utilizzati detersivi che contengano cloro o a base di acido cloridrico, acido muriatico o prodotti anticalcare in quanto andrebbero ad alterare la brillantezza del prodotto.

MANUTENZIONE LEGNO

Il legno è un materiale vivo e come tale può avere mutamenti nel tempo di colore e di dimensione, gli oggetti che vengono appoggiati sul piano, devono essere spostati periodicamente poiché il legno è sensibile alla luce e si ossida, creando differenze di colore tra le parti esposte alla luce e quelle coperte. Per la normale pulizia utilizzare un panno morbido leggermente umido. Non usare detersivi abrasivi, solventi, ammoniacca, acetone o petrolio. Per la rimozione di macchie utilizzare una soluzione di acqua e sapone neutro, avendo l'accortezza di asciugare subito le superfici bagnate.



ATTENZIONE

Non spostare assolutamente mai il prodotto trascinandolo o sollevandolo prendendolo per il piano ma smontarlo e riposizionarlo dove voluto, assicurandosi di proteggere le parti che si potrebbero danneggiare.



SMALTIMENTO

Una volta dismesso, il prodotto od i suoi componenti non vanno dispersi nell'ambiente ma conferiti ai sistemi pubblici di smaltimento.

Riporre per eventuali consultazioni future.



USE

The product is intended to be used in the inside and for the purposes it was created for.



ACCOMPLISHMENT



Small irregularities on the base are due to manual processing.

MAINTENANCE

It is recommended not to use metal sharp tools or abrasive clothes to eliminate dirt from the surface, because they could damage the same. Do not absolutely use detergents containing chlorine, muriatic acid, hydrochloric acid or descale detergents which can damage the surface brilliance.

MAINTENANCE WOOD

Wood is a living material and therefore susceptible to slight colour and dimension changes. As the wood is sensitive to light and oxidizes, any item standing in the same place on the top for a long period of time can create colour differences between the covered and the exposed parts, so they should be moved periodically. Clean it with a slightly damp soft cloth. DO NOT use any chemicals or harsh detergents such as ammonia. To remove stains, wash the top with mild soap and water, and rinse. Dry the top thoroughly.



WARNING

Do not absolutely move the product dragging it or lifting it by gripping the top, but isassemble it and then place it in the new site, protecting the parts that could be damaged.



DISPOSAL

Once discarded, neither the product nor its components should be dispersed in the environment, but rather consigned to public disposal systems.

File for future consultation.



NUTZUNG

Das Produkt ist nur für den Innenbereich gedacht. Der Tisch wurde hergestellt, nur als Esstisch genutzt zu werden.



AUSFÜHRUNG



Kleine Unregelmäßigkeiten auf der Basis sind nicht zu vermeiden, da das Teil per Hand hergestellt wird.

WARTUNG

Niemals scharfe Werkzeuge aus Metall, spitzen Instrumente oder Schleifmittel für die Reinigung der Oberfläche verwenden. Diese Produkte können die Oberfläche beschädigen. Niemals Chemikalien mit chlorhaltigen Salzsäure, Salzsäure oder Kalk-Produkte für die Reinigung verwenden. Diese Produkte können der Glanz beschädigen.

PFLEGE DES HOLZES

Holz ist ein lebendes Material und kann sich in der Farbe und Größe ändern. Objekte, die auf die Platte gestellt werden, müssen periodisch bewegt werden, da Holz lichtempfindlich ist und oxidiert und dadurch die Farbe ändert. Für die normale Reinigung genügt ein weiches, feuchtes Tuch. Bitte kein Scheuermittel, Lösungsmittel, Ammoniak, Aceton oder Öl verwenden. Zum Entfernen von Flecken milde Seife und Wasser benutzen, die nassen Oberflächen sofort abtrocknen.



ACHTUNG

Der Tisch absolut nie ziehen oder heben. Falls der Tisch soll bewegt werden, muss zerlegt werden und sorgfältig in der neue Stelle Positioniert. Die empfindliche teile sollen geschützt werden.



ENTSORGUNG

Nach der Aussonderung ist das Produkt und seine Bestandteile nicht selbständig im Freien zu entsorgen, sondern der städtischen Müllabfuhr zu übergeben.

Bitte aufbewahren für eventuelle spätere Nachfragen.

F**UTILISATION**

Le produit est destiné pour une utilisation à l'intérieur des habitations.

**CONSTRUCTION**

Les petites irrégularités sur la base sont dues à une fabrication manuelle.

MANUTENTION

Il ne faut pas absolument utiliser des outils pointus ou des chiffons abrasifs pour éliminer des possibles restes sur la surface du produit, parce qu'ils peuvent endommager la surface même. Ne pas utiliser des détergents contenant du chlore, acide chlorhydrique, acide muriatique ou produits anticalcaire qui peuvent altérer le brillant du produit.

ENTRETIEN BOIS

Le bois est une matière qui vit, et comme tel il peut avoir des changements de couleur, de dimension, les objets posés sur le plateau doivent être posés de façon intermittente car la sensibilité à la lumière peut créer des différences de ton entre les parties du plateau couvertes ou non par les objets. Pour l'entretien, utilisez un chiffon doux et légèrement humide. Ne pas utiliser de revêtements abrasifs, ammoniacaux ou autres détergeants. Pour enlever les taches utiliser de l'eau et du savon neutre, en essuyant immédiatement les parties concernées.

ATTENTION

Ne pas absolument déplacer le produit en le traînant ou en le soulevant par le top, mais démontez-le et positionnez-le autre part, en s'assurant de protéger les parties qui pourraient s'endommager.

**ECOULEMENT**

Une fois disloqué, le produit ou ses composants ne doivent pas être dispersés dans la nature mais confiés aux décharges publiques.

A conserver pour les futurs besoins de référence.

E**USO**

El producto está destinado para su uso dentro del hogar, a los fines por los cuales fue creado.

**CONSTRUCCIÓN**

Pequeñas irregularidades en la base están causadas por la producción manual.

MANTENIMIENTO

No utilizar en cualquier forma instrumentos de metal afilados o telas abrasivas para eliminar cualquier resto de suciedad en la superficie del producto, ya que pueden dañar la superficie misma. No utilizar en cualquier forma limpiadores a base de cloro o que contienen ácido clorhídrico, ácido muriático o productos anticalcáreos ya que pueden alterar el brillo del producto.

MANTENIMIENTO MADERA

La madera es un material vivo y, como tal, puede tener cambios con el tiempo de color y tamaño, los objetos que se colocan en el sobre, se deben mover periódicamente ya que la madera es sensible a la luz y se oxida, creando diferencias de color entre las piezas expuestas a la luz y las cubiertas. Para la limpieza normal, use un paño suave ligeramente humedecido. No use limpiadores abrasivos, disolventes, amoníaco, acetona y aceite. Para quitar las manchas utilizar una solución de jabón suave y agua, asegurándose de secar las superficies mojadas inmediatamente.

ATENCIÓN

No muevan absolutamente nunca el producto arrastrándolo o mediante el levantamiento del plano, sino desmontarlo y llevarlo a donde querían, asegurándose de proteger las partes que pueden dañarse.

**ELIMINACIÓN DE DESECHOS**

Una vez desechado, el producto o sus componentes no se tienen que abandonar en el entorno sino entregar al sistema público de recogida de basuras.

Guardar para consultas posteriores.

**cattelan
italia**

CATTELANITALIA.COM



CATTELAN ITALIA SPA – via pilastri 19 – 36010 Carré / Vicenza – Italy
phone +39 0445 318711 - fax +39 0445 314289 - email: info@cattelanitalia.com