

cattelan italia

TABLES



TAVOLI - CONSOLE - CONSOLE ALLUNGABILI - SCRIVANIE
TABLES - CONSOLES - EXTENDIBLE CONSOLES - DESKS



TAVOLI

Dining Tables_Tables
Mesas_Tische_Стол

PAGE	
153	BORA BORA
176	BORA BORA BISTROT
100	CARIOCA
132	CORAL
152	CORTINA
128	DIAPASON
114	DOMINO
84	ELIOT
80	ELIOT KERAMIK
146	ELIOT ROUND
76	ELIOT WOOD
162	ELVIS
160	ELVIS KERAMIK
158	ELVIS WOOD
142	GIANO
138	GIANO KERAMIK
106	GOBLIN
171	HENRY
26	HYSTRIX
170	HUGO BISTROT
66	IKON
110	JEREZ
92	MONACO
116	MUSEUM
166	OBELISCO
154	PEDRO
134	PLISSET
150	RAY
130	REEF
58	RIVER
172	ROGER
174	ROGER KERAMIK
88	SIGMA

TAVOLI ALLUNGABILI

Extendible Dining Tables
Tables à rallonges_Mesas Extensibles
Verlängbare Tische_Стол с раскладкой

PAGE	
218	AZIMUT
230	BRERA
222	DAYTONA
226	DAYTONA ALMOND
200	ELAN DRIVE
190	ELIOT DRIVE
186	ELIOT KERAMIK DRIVE
182	ELIOT WOOD DRIVE
251	ELVIS DRIVE
250	ELVIS WINGS
238	ELVIS WOOD DRIVE
192	IKON DRIVE
206	JEREZ DRIVE
198	MONACO DRIVE
234	MONDAY
246	NEMO DRIVE
242	PEDRO DRIVE
196	SIGMA DRIVE
212	ZEUS DRIVE
216	ZEUS KERAMIK DRIVE

CONSOLLE

Consoles_Consoles
Consolas_Konsolen_Консоли

PAGE	
278	DIAPASON CONSOLLE
279	ELVIS CONSOLLE
280	HORIZON
268	MONACO CONSOLLE
276	MUSEUM CONSOLLE
274	PORTOFINO
272	RAPA NUI
264	TOUR CONSOLLE
262	VALENTINO CONSOLLE
260	VALENTINOX CONSOLLE
255	WESTIN
254	WESTIN WOOD
282	WISH BOARD

CONSOLLE ALLUNGABILI

Extendible Consoles_Consoles à rallonges
Consolas Extensibles_Verlängbare Konsolen
Консоли с раскладкой

PAGE	
287	CONVIVIUM
300	ELVIS CONSOLLE DRIVE
296	NEMO CONSOLLE
292	PARTY

SCRIVANIE

Desks_Bureaux
Escritorios_Schreibtische
Письменные Столы

PAGE	
320	BATIK
328	DAVINCI
324	DYNO DESK
330	ISLAND
327	IAP
304	NASDAQ
316	QWERTY
322	STORM
310	VEGA



TAVOLI _TABLES



BORA BORA 153



BORA BORA BISTROT 176



CARIOCA 100



CARIOCA 102



CORAL 132



CORTINA 152



DIAPASON 128



DOMINO 114

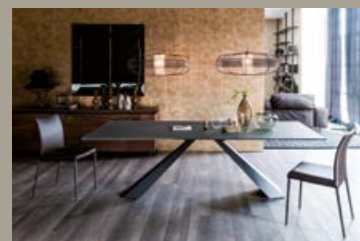

ELIOT 84



ELIOT KERAMIK 80



ELIOT ROUND 146



ELIOT WOOD 76



ELVIS 162

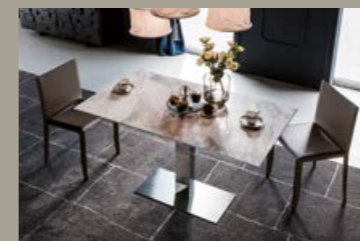

ELVIS KERAMIK 160



ELVIS WOOD 158



GIANO 142



GIANO KERAMIK 138



GOBLIN 106



HENRY 171

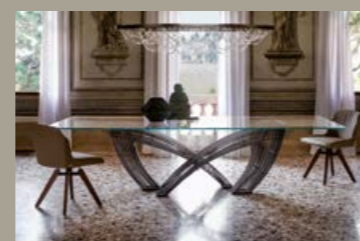

HYSTRIX 26



HUGO BISTROT 170



IKON 66



JEREZ 110



MONACO 92



MUSEUM 116



OBELISCO 166



PEDRO 154



PLISSET 134



RAY 150



REEF 130



RIVER 58



ROGER 172



ROGER KERAMIK 174



SIGMA 88



SKORPIO 50



SKORPIO KERAMIK 42



SKORPIO ROUND 144



SKORPIO WOOD 34



SPYDER 18



SPYDER WOOD 10



VALENTINO 120



VALENTINOX 124



VIOLA D'AMORE 126



XOM KERAMIK 178

SPYDER WOOD

Design Philip Jackson

Tavolo con base in acciaio verniciato opaco bianco, nero, graphite, ottone anticato, inox o noce Canaletto.

Versione "S" con bordi irregolari in massello in noce Canaletto, rovere bruciato o rovere naturale spessore 4 cm.

Versione "A": piano con bordi obliqui in noce Canaletto, rovere Heritage o rovere naturale, il piano 200x100 ha lo spessore di 4 cm, il 240x120 e il 300x120 di 5 cm.

Table with base in matt white, matt black, matt graphite, brass weathered varnished steel, stainless steel or Canaletto walnut.

4 cm thick top **"S" version** with irregular solid wood edges in Canaletto walnut, burned oak or natural oak.

Version "A": top with angled edges in Canaletto walnut, Heritage oak or natural oak. Wooden top 4 cm on 200x100 version and 5 cm on 240x120 and 300x120 versions.

Table avec base en acier verni blanc mat, noir mat, graphite mat, laiton antique, inox ou noyer Canaletto.

Version "S" avec bord irréguliers en bois massif noyer Canaletto, rouvre brûlé ou rouvre naturel en épaisseur 4 cm.

Version "A": plateau en noyer Canaletto, rouvre Heritage ou rouvre naturel avec bords biseautés. Plateau 200x100 avec épaisseur 4 cm, plateaux 240x120 et 300x120 avec épaisseur 5 cm.

Mesa con base en acero lacado blanco mate, negro mate, graphite mate, latón antiguo, acero inox o nogal Canaletto.

Grosor sobre de 4 cm en la **versión "S"** en nogal Canaletto, roble ahumado o roble natural con bordes irregulares en maciso.

Versión "A": sobre en nogal Canaletto, roble Heritage o roble natural con bordes obliquos. Sobre 200x100 con grosor 4 cm, sobre medidas 240x120 y 300x120 grosor 5 cm.

Tisch mit Basis in lackiertem Stahl matt weiss, matt schwarz, matt graphite, Messing antik, Edelstahl oder Nussbaum Canaletto.

Version "S" mit irregelmessigen Kanten in massives Holzes noce Canaletto oder verbrannte Eiche oder Eiche Natur. Dicke den Platten 4 cm.

Version "A": Platte in Nussbaum Canaletto, Eiche Heritage oder Natur Eiche mit schräge Kanten. Die Platte 200x100 hat 4 cm Dicke, die Platten in 240x120 und 300x120 haben 5 cm Dicke.

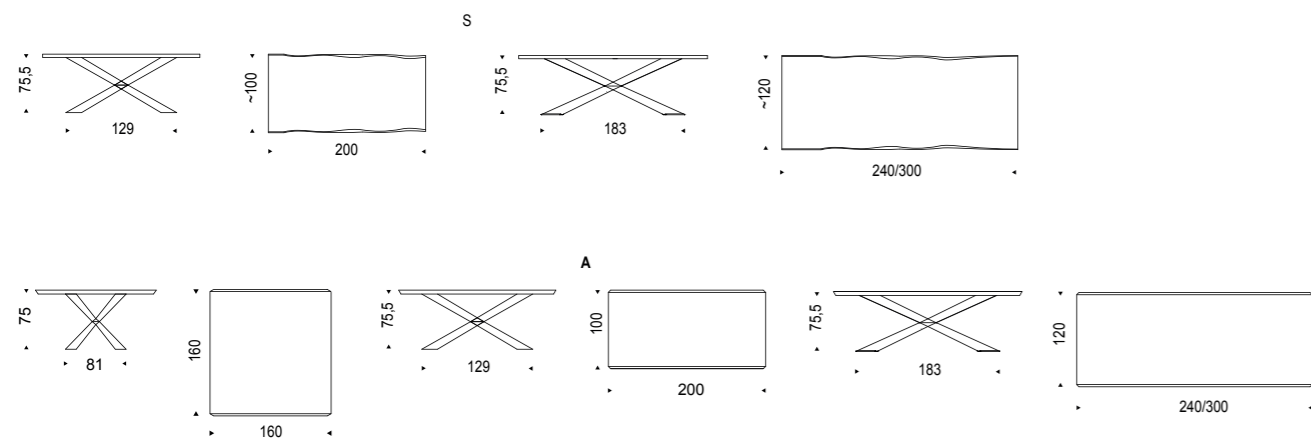

SPYDER WOOD A



table SPYDER WOOD S (Canaletto walnut) - chairs ISABEL - lamps VENEZIA



table SPYDER WOOD S (Canaletto walnut) - chairs SAMANTHA - lamp VENEZIA - rugs JAIPUR, CHENNAI, DEHI



table SPYDER WOOD S (burned oak) - chairs MAGDA B - lamps KIDAL - wall lamp VENEZIA - rug CHEN



SPYDER**Design Philip Jackson**

Tavolo con base in acciaio verniciato opaco bianco, nero, graphite, ottone anticato, inox, noce Canaletto o dark wenghè. Piano in appoggio in cristallo 15mm trasparente o trasparente extrachiaro. I piani 182x90 e 200x106 hanno spessore 12mm. Piccole irregolarità di riflessione sulla base in acciaio sono dovute alla lavorazione manuale.

Table with base in matt white, matt black, matt graphite or brass wheatered varnished steel, stainless steel, Canaletto walnut or dark wenghè. Top in 15mm clear or extra clear glass, laid on the base. Glass top 12mm on 200x106 and 182x90 version. Small reflection's irregularities on the stainless steel base are due to manual processing.

Table avec base en acier verni blanc mat, noir mat, graphite mat, laiton antique, inox, noyer Canaletto ou dark wenghè. Plateau en appui en verre 15mm transparent ou extra-clair transparent. Version 182x90 et 200x106 épaisseur 12mm. Les petites irrégularités de réflexion sur la base en acier inox sont dues à une fabrication manuelle.

Mesa con base en acero lacado blanco mate, negro mate, graphite mate, latón antiguo, inox, nogal Canaletto o dark wenghè. Sobre en apoyo en cristal 15mm transparente o transparente extraclaro. El sobre 182x90 y 200x106 es de 12mm. Pequeñas irregularidades de reflexión en la base de acero inox están causadas por la producción manual.

Tisch mit Basis aus lackiertem Stahl matt weiß, matt schwarz, matt graphite, Messing antik, Edelstahl, Nußbaum Canaletto oder dark wenghè. Transparentes oder Opti-Whitel transparentes Glas 15mm. Die Platte in der Größe 182x90 und 200x106 hat eine Dicke von 12mm. Platte auf dem Basis gelegt. Kleine Unregelmäßigkeiten der Basis in Edelstahl sind nicht zu vermeiden, da das Teil per Hand hergestellt wird.

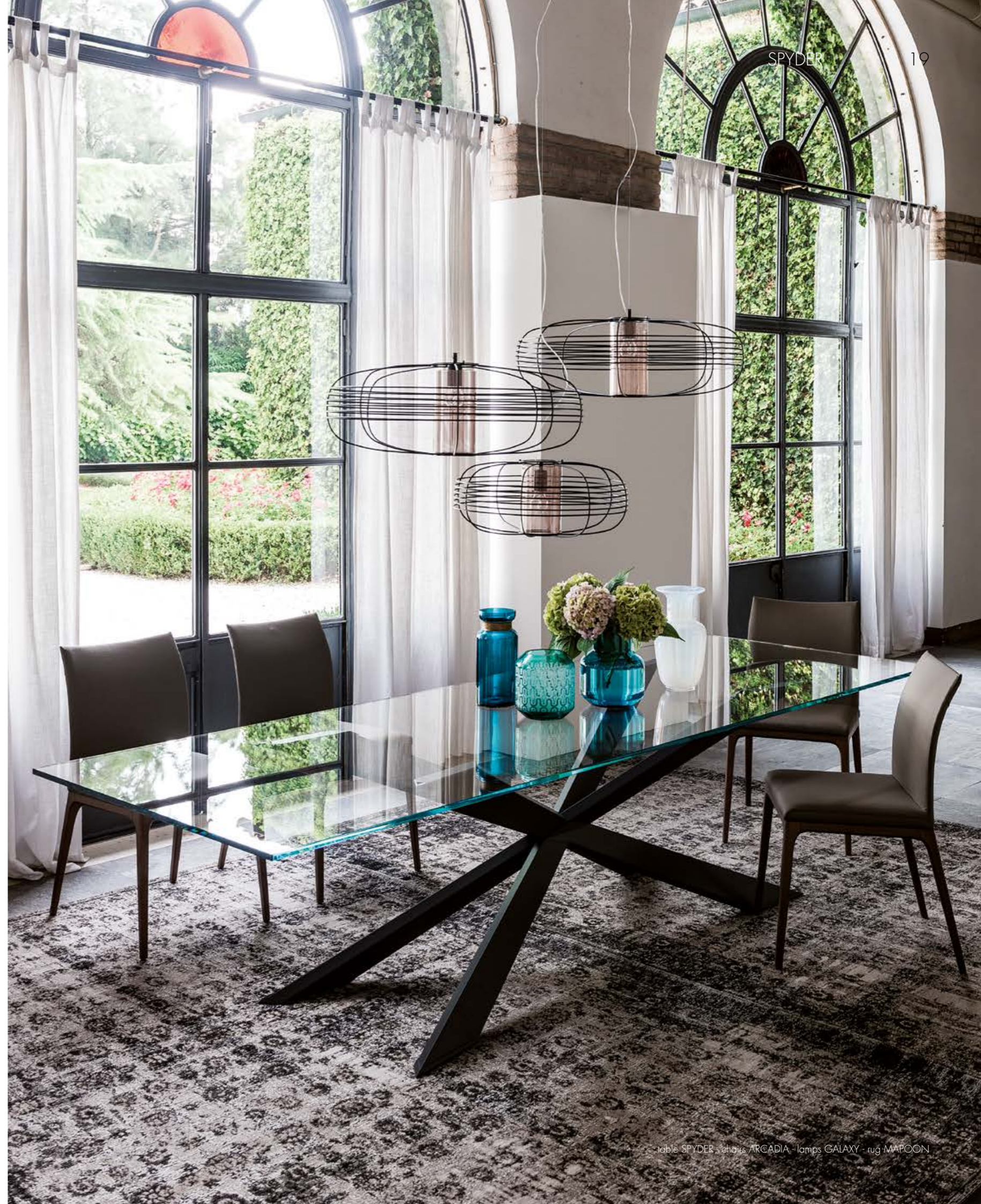
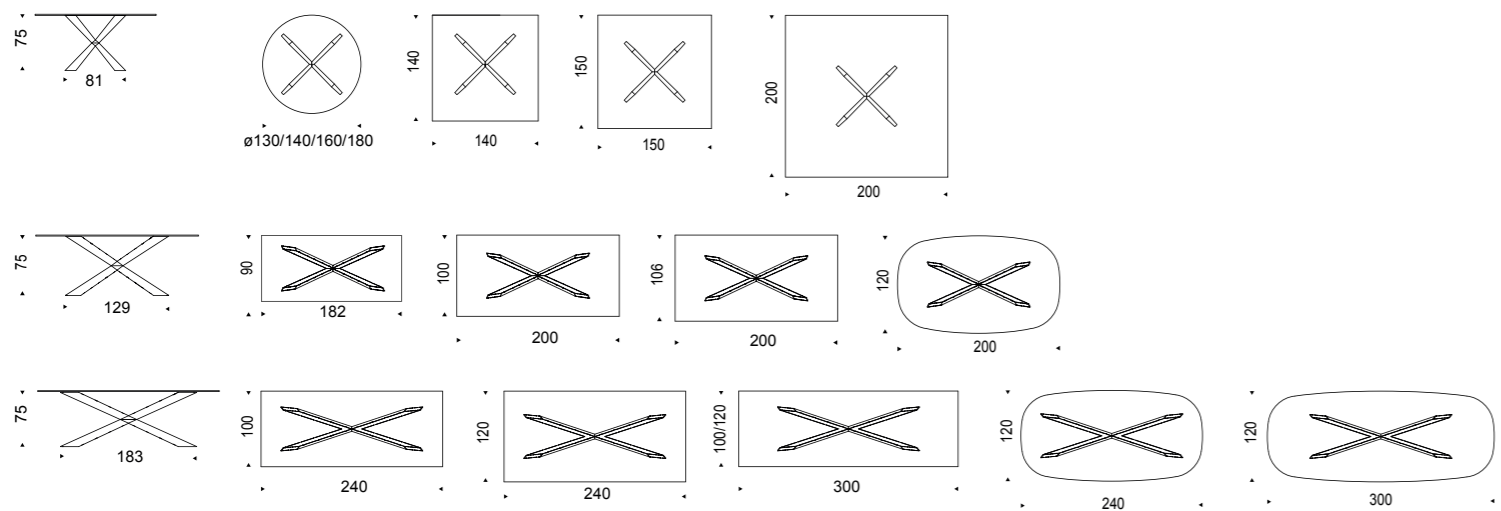





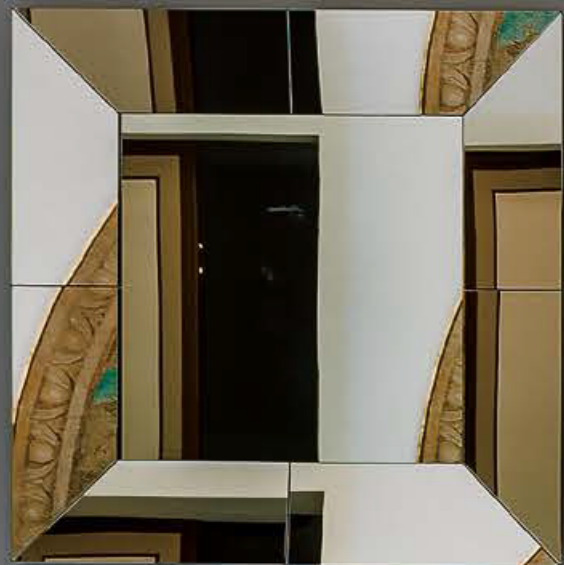

HYSTRIX

Design **Giorgio Cattelan**

Tavolo con base in acciaio verniciato trasparente. Piano in appoggio in cristallo 15mm trasparente, trasparente extrachiaro o trasparente extrachiaro con bordi bisellati inversi. La finitura OPO della base identifica una verniciatura trasparente su materiale ferroso grezzo.

Table with transparent varnished steel base. Top in 15mm clear, extra clear or extra clear glass with reversed bevelled edges. The top is laid on the base. The finish of the base OPO identifies a transparent coating on ferrous raw material.

Table avec base en acier laqué transparent. Plateau en verre clair 15 mm, extra-clair ou extra-clair avec bords biseautés inversés. Plateau d'appui. La finition de la base OPO, identifie un revêtement transparent sur le matériel en fer brut.

Mesa con base en acero barnizado transparente. Sobre en cristal 15mm transparente, transparente extraclaro o transparente extraclaro con bordes biselados inversos. Sobre en apoyo. El acabado OPO de la base identifica una barniz transparente de la materia prima de hierro.

Esstisch mit Basis aus Stahl lackiert transparent. Platte in 15mm Glas transparent, extra hell transparent, oder extra hell mit Kanten umgekehrt facettiert. Platte auf dem Basis gelegt. Die Ausführung der Basis OPO identifiziert eine transparente Beschichtung auf roh Stahl.

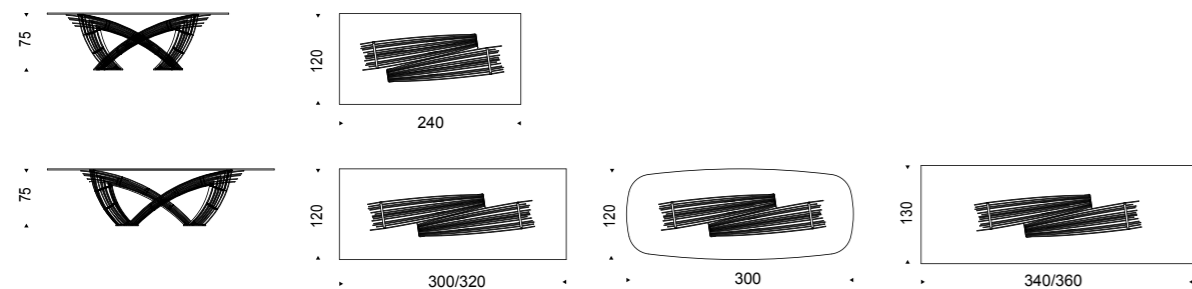



table HYSTRIX - chairs TYLER - lamp CRISTAL



table HYSTRIX - chairs MAGDA B - lamp CRISTAL



NOCE CANALETTO - WALNUT CANALETTO
TOP VERSION S



ROVERE BRUCIATO - BURNED OAK
TOP VERSION S



ROVERE HERITAGE - HERITAGE OAK
TOP VERSION A

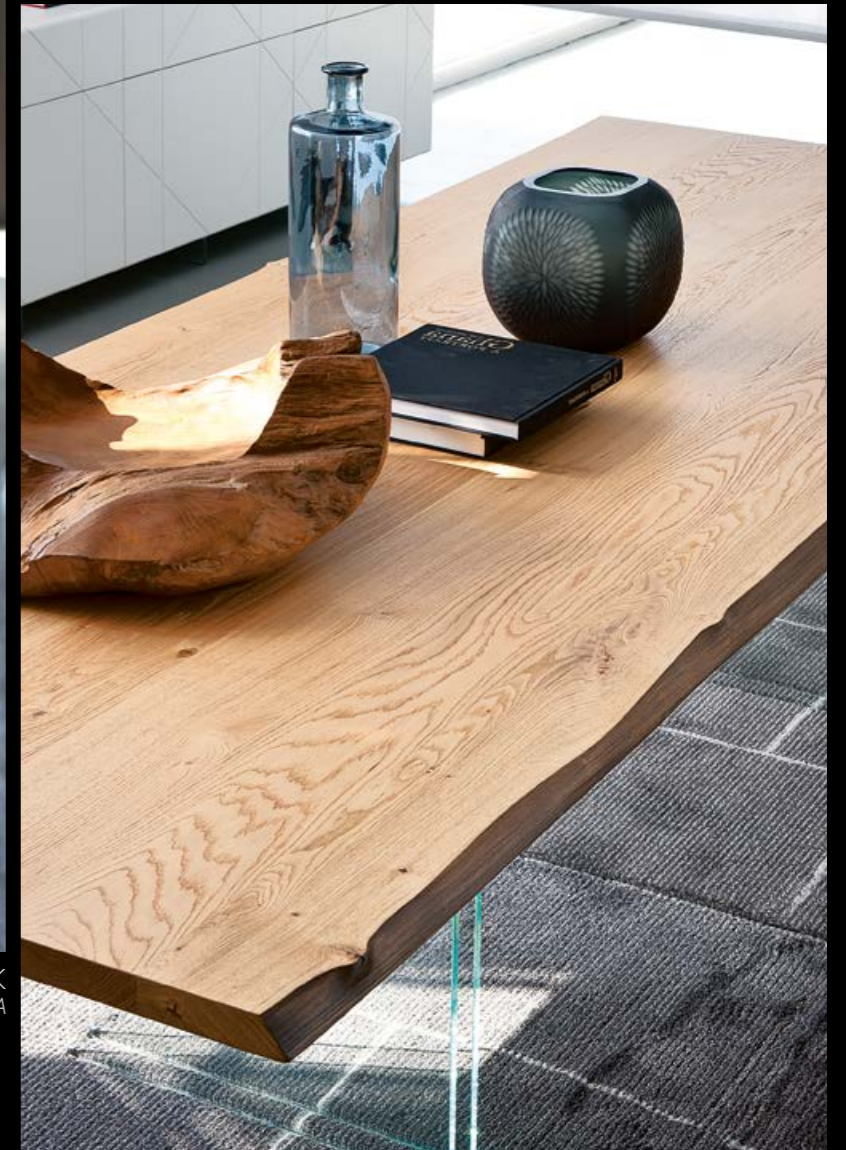

ROVERE NATURALE - NATURAL OAK
TOP VERSION S

SKORPIO WOOD

Design **Andrea Lucatello**

Tavolo con base in acciaio verniciato trasparente, bianco, black graphite embossed lacquered steel or orange fluo. **Versione A:** piano con bordi obliqui in legno noce Canaletto o rovere Heritage, il piano 160x160 e 200x100 hanno lo spessore di 4 cm, il 240x120 e il 300x120 di 5 cm.

Versione "B": piano a botte in noce Canaletto, rovere bruciato o rovere naturale con bordi bisellati. **Versione "S":** piano con bordi irregolari in massello di noce Canaletto, rovere bruciato o rovere naturale, spessore 4 cm.

Table with transparent varnished metal base, white, black graphite embossed lacquered steel or orange fluo. **A version:** top with angled edges in Canaletto walnut or Heritage oak.

4 cm thick wooden top on 160x160 and 200x100 versions and 5 cm on 240x120 and 300x120 versions.

Vesion "B": barrel top with bevelled edges in Canaletto walnut, burned oak or natural oak.

Version "S": top with irregular solid wood edges in Canaletto walnut, burned oak or natural oak, 4 cm thickness.

Table avec base en acier verni transparent, gaufré blanc, noir graphite ou orange fluo.

Version A: plateau avec bords biseauté en bois noyer Canaletto ou rovere Heritage. Les plateaux 160x160 et 200x100 ont une épaisseur de 4 cm, les plateaux 240x120 et 300x120 de 5 cm.

Version "B": plateau avec bords biseauté en noyer Canaletto, rovere brûlé ou rovere naturel.

Version "S": plateau en noyer Canaletto, rovere brûlé ou rovere naturel avec bords irréguliers en bois massif. Épaisseur 4 cm.

Mesa con base en acero barnizado transparente, gofrado blanco, negro graphite o naranja fluo. **Versión A:** sobre con bordes oblicuos en nogal Canaletto o roble Heritage. Grosor sobre de 4 cm en las medidas 160x160 cm y 200x100 cm y de 5 cm en las medidas 240x120 cm y 300x120 cm.

Versión "B": sobre con bordes biselados en nogal Canaletto, roble ahumado o roble natural.

Versión "S": sobre en nogal Canaletto, roble ahumado o roble natural con bordes irregulares en macizo. grosor 4 cm.

Esstisch mit Basis aus Metall lackiert transparent, weiß, schwarz, graphit gaufriert oder orange fluo.

Version A: platte mit schräge Kanten in Nussbaum Canaletto oder Eiche Heritage. Die Platten 160x160 und 200x100 sie haben 4 cm Dicke, die Platten in 240x120 und 300x120 haben 5 cm Dicke.

Version "B": Platte mit schräge Kanten aus Nussbaum Canaletto, "verbrannte Eiche" oder Natur Eiche.

Version "S": Platte in Nussbaum Canaletto, "verbrannte Eiche" oder Natur Eiche mit massiven und unregelmäßigen Kanten. 4 cm Dicke.

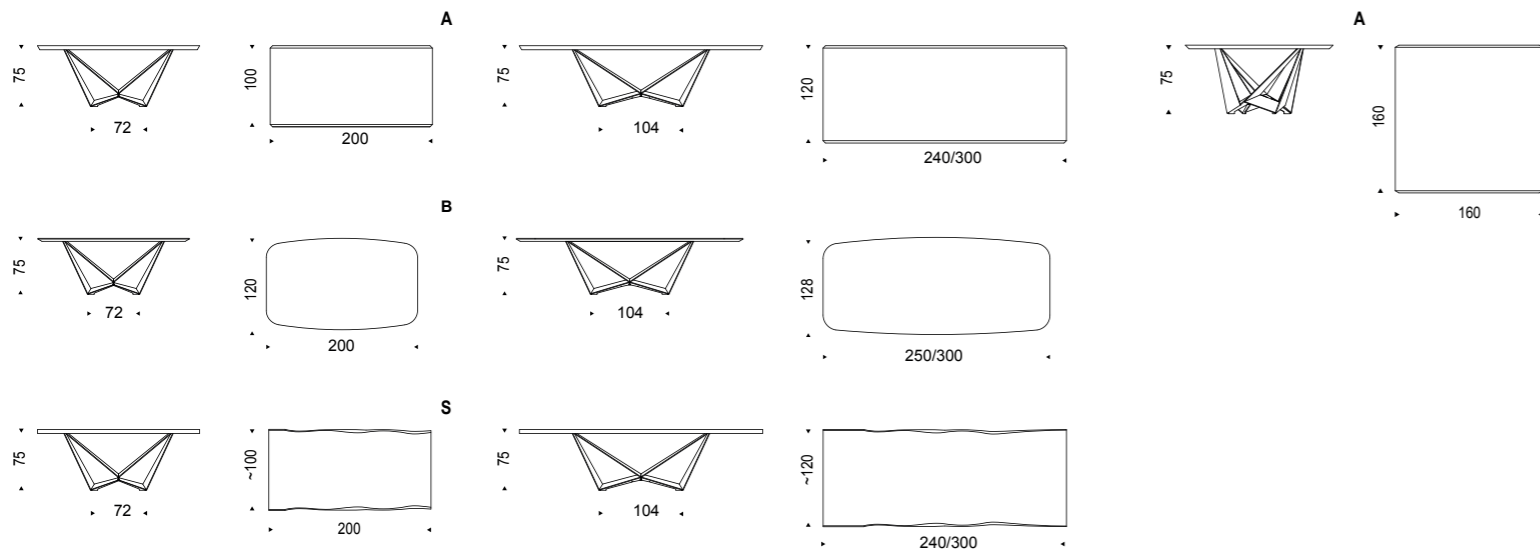

SKORPIO WOOD S



table SKORPIO WOOD B - chairs ARCADIA - lamps VENEZIA - sideboard EUROPA - mirror WISH





table SKORPIO WOOD A (heritage oak) - chairs TOSCA - lamps KIDAL



SKORPIO KERAMIK

Design A. Lucatello & P. Cattelan

Tavolo con base in acciaio verniciato trasparente, arancio fluo, goffrato bianco, nero o graphite. Piano in ceramica Marmi Calacatta, Alabastro o Ardesia.

Table with transparent varnished metal base, orange fluo, white, black or graphite embossed lacquered steel. Top in ceramic Marmi Calacatta, Alabastro or Ardesia.

Table avec base en acier laqué transparent, orange fluo, gaufré blanc, noir ou graphite. Plateau en céramique Marmi Calacatta, Alabastro ou Ardesia.

Mesa con base en acero barnizado transparente, naranja fluo, gofrado blanco, negro o graphite. Sobre en cerámica Marmi Calacatta, Alabastro o Ardesia.

Esstisch mit Basis aus Metall lackiert transparent, fluo orange oder weiß, schwarz oder graphite gaufriert. Platte in Keramik Marni Calacatta, Alabastro oder Ardesia.

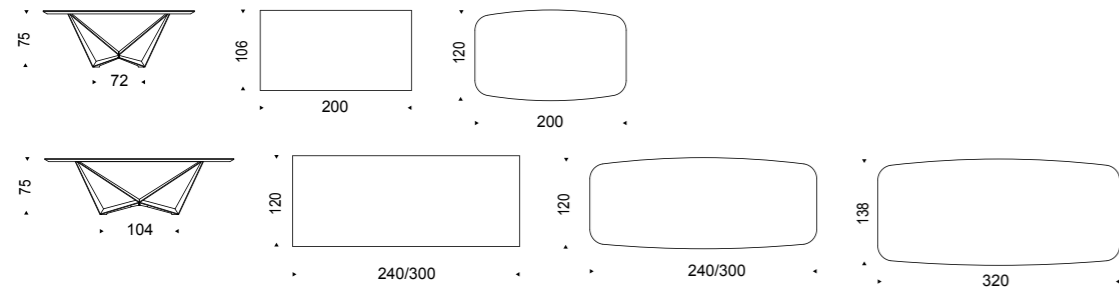

SKORPIO KERAMIK ROUND

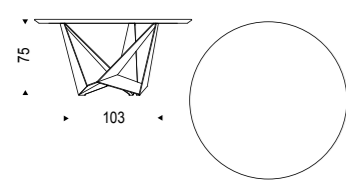

LAZY SUSAN

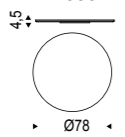

Ceramic Alabastro



table SKORPIO KERAMIK (Calacatta) - chairs MAGDA B - lamps VENEZIA - sideboard EUROPA



table SKORPIO KERAMIK (Colacatta) - chairs TOSCA - lamps VENEZIA





SKORPIO**Design Andrea Lucatello**

Tavolo con base in acciaio verniciato trasparente, arancio fluo, gofrato bianco, nero o graphite. Piano in cristallo 15mm trasparente, trasparente extrachiaro o trasparente extrachiaro con bordi bisellati inversi. I piani 182x90 e 200x106 hanno spessore 12mm. Piano in appoggio.

Table with transparent varnished metal base, orange fluo, white, black or graphite embossed lacquered steel. Top in 15mm clear, extra clear or extra clear glass with reversed bevelled edges. Glass top 12mm on 182x90 and 200x106 versions. The top is laid on the base.

Table avec base en acier verni transparent, orange fluo, gaufré blanc, noir ou graphite. Plateau en verre clair 15 mm, extra-clair ou extra-clair avec bords biseautés inversés. Les plateaux 182x90 et 200x106 sont de 12mm. Plateau d'appui.

Mesa con base en acero barnizado transparente, naranja fluo, gofrado blanco, negro o graphite. Sobre en cristal 15mm transparente, transparente extraclaro o transparente extraclaro con bordes biselados inversos. Los sobres 182x90cm y 200x106cm son de 12mm. Sobre en apoyo.

Esstisch mit Basis aus Metall lackiert transparent, orange fluo oder weiß, schwarz oder graphit gaufriert. Platte in 15mm Glas transparent, extra hell transparent, oder extra hell mit Kanten umgekehrt facettiert. Platten in 182x90 und 200x106 haben 12 mm Dicke. Platte auf dem Basis gelegt.

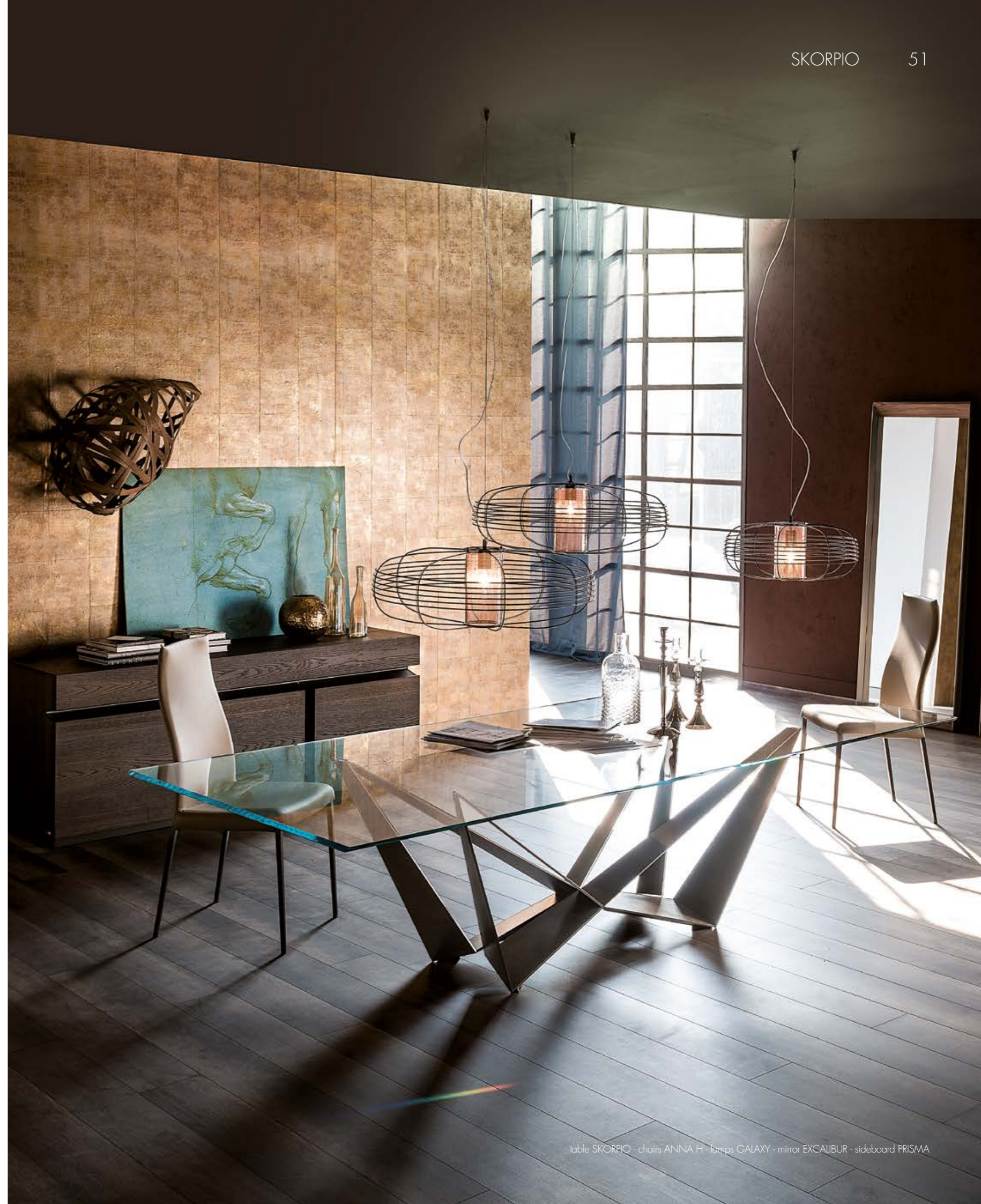
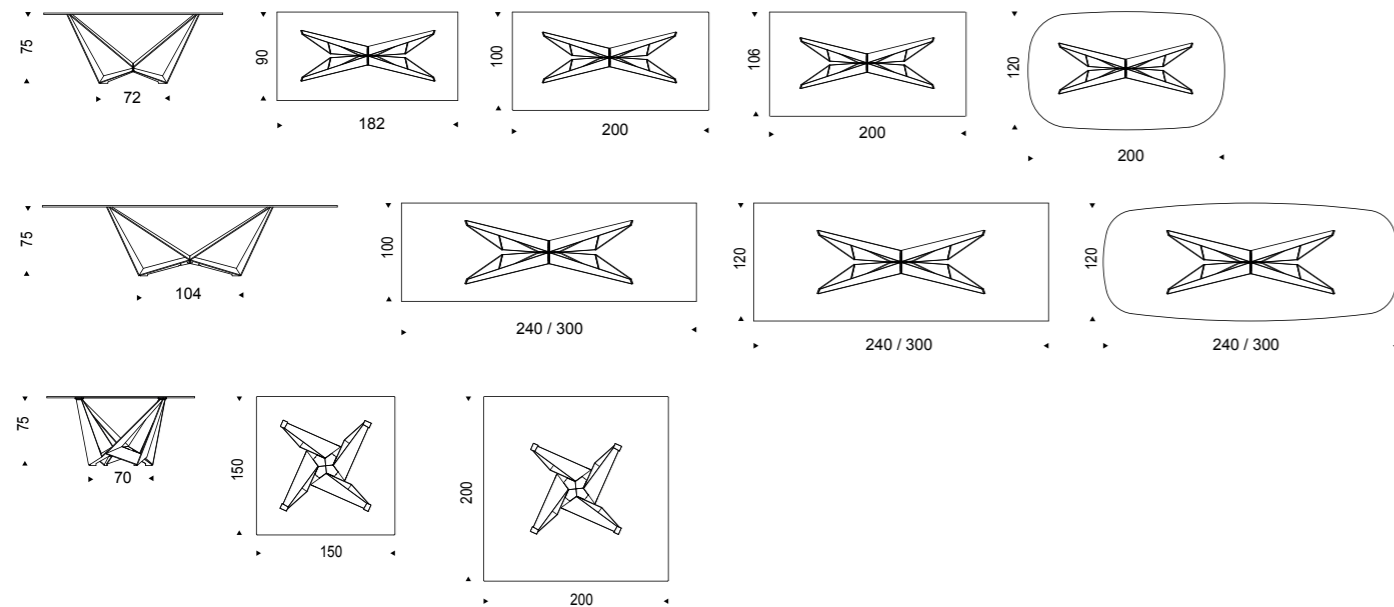





table SKORPIO (orange fluo) - chairs MAGDA and MAGDA B - lamps DREAM - mirror TAXEDO - sideboard KAYAK



table SKORPIO - chairs LIZ - lamps APOLLO - consolle WESTIN - mirror STRIPES



table RIVER (Canaletto) - chairs ISABEL - lamps ZEPPELIN - bookcase AIRPORT - rug MAPOON

RIVER

Design Daniele Molteni

Tavolo con base in acciaio verniciato gofrato bianco, nero o graphite. Piano in legno noce Canaletto o rovere bruciato con inserto centrale in cristallo extrachiaro stratificato.

Table with base in white, black or graphite embossed lacquered steel. Top in Canaletto walnut or burned oak with central insert in extra clear laminated glass.

Table avec base en acier gaufré blanc, noir ou graphite. Plateau en noyer Canaletto ou roivre brûlé avec insert central en verre extra clair stratifié.

Mesa con base en acero barnizado gofrado blanco, negro o graphite. Sobre en madera nogal Canaletto o roble ahumado con detalle central en cristal transparente extraclaro estratificado.

Esstisch mit Basis in Edelstahl lackiert weiß oder graphite gaufriert. Platte in Nussbaum Canaletto oder "verbrannte Eiche" mit Zentraleinsatz aus Glas extrahell geschichtet.

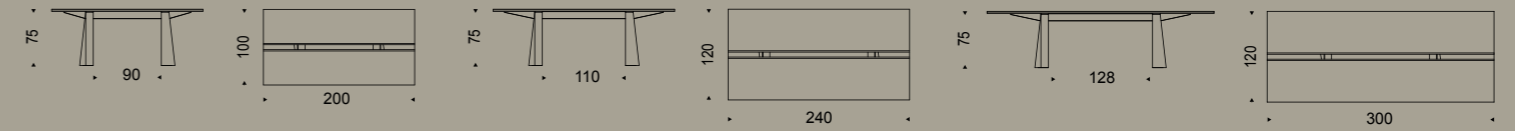

Canaletto walnut



table RIVER (Canoletta) - chairs ARCADIA - lamp ZEPPELIN - sideboard KAYAK



Canaletto walnut



table RIVER (Canaletto) - chairs ISABEL - lamp ZEPPELIN - sideboard KAYAK



burned oak



table RIVER (burned oak) - chairs ARCADIA - lamps HUBLOT - sideboard PRISMA

IKON**Design Philip Jackson**

Tavolo con base in cristallo temperato extrachiaro trasparente 15mm e trave in graphite. Piano in noce Canaletto, rovere bruciato o rovere naturale con bordi irregolari in massello. Disponibile anche trave in noce Canaletto, rovere bruciato o rovere naturale.

Table with 15mm extraclear tempered glass base and graphite beam. Top in solid Canaletto walnut, burned oak or natural oak with irregular solid wood edges. Available also Canaletto walnut, burned oak or natural oak beam.

Table avec piétement en verre trempé extra-clair transparent 15mm et traverse en graphite. Plateau en noyer Canaletto, rovere brulé ou rovere naturel. Bords irréguliers en bois massif. Disponible aussi traverse en noyer Canaletto, rovere brulé ou rovere naturel.

Mesa con base en cristal templado extraclearo transparente 15mm y viga en graphite. Sobre en nogal Canaletto, roble ahumado o roble natural con bordes irregulares en macizo. Disponible también viga en nogal Canaletto, roble ahumado o roble natural.

Esstisch mit Basis aus 15mm extra hell transparentem gehärtetem Glas und Holm aus graphite. Platte aus Nussbaum Canaletto, "verbrannte Eiche" oder Eiche Natur mit massiven Kanten. Holm aus Nussbaum Canaletto, "verbrannte Eiche" oder Eiche Natur verfügbar.

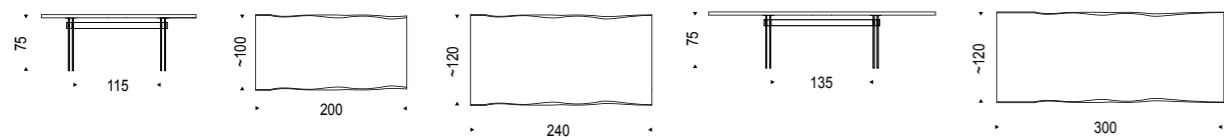

IKON DRIVE → EXTENDABLE TABLE pag. 192

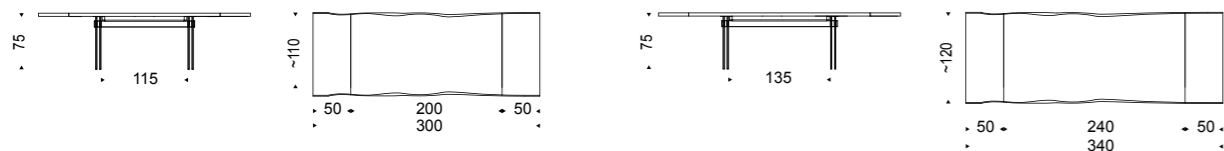





table IKON (burned oak) - chairs MUSA B - lamps CRISTAL



burned oak



Table IKON (natural oak) - chairs ARCADIA and AGATHA FLEX SLIM - lamps BOLERO and ZEPPELIN - sideboard TROPEZ - bookcase LOFT



ELIOT WOOD**Design Giorgio Cattelan**

Tavolo con base in acciaio verniciato gofrato bianco, nero, graphite o inox satinato. Piano in legno noce Canaletto, rovere bruciato o rovere naturale con bordi irregolari in massello.

Table with base in white, black or graphite embossed lacquered steel or in satin stainless steel. Top in Canaletto walnut, burned oak or natural oak with irregular edges.

Table avec base en acier inox mat ou gaufré verni blanc, noir ou graphite. Plateau en noyer Canaletto, rovre brûlé ou rovre naturel avec bords irréguliers en bois massif.

Mesa con base en acero inox satinado o barnizado gofrado blanco, negro o graphite. Sobre en madera nogal Canaletto, roble ahumado o roble natural con bordes irregulares en macizo.

Esstisch mit Basis in Edelstahl lackiert weiss, schwarz oder graphite gaufriert oder in Edelstahl gebürstet. Platte in Nussbaum Canaletto, "verbrannte Eiche" oder Eiche Natur mit massiven Kanten.

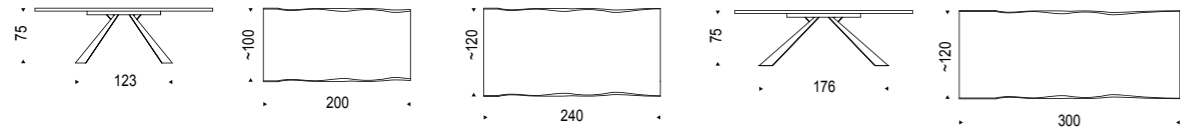
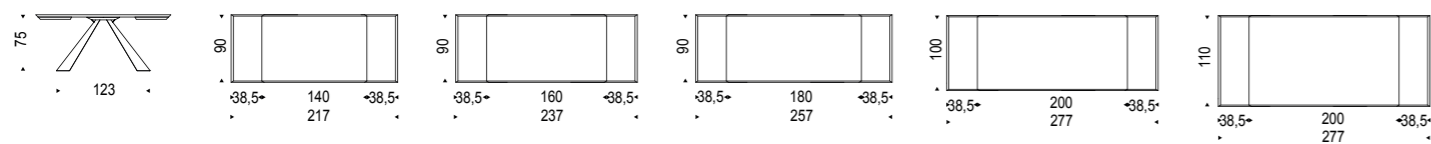
**ELIOT WOOD DRIVE → EXTENDABLE TABLE pag. 182**

rovere bruciato - burned oak



ELIOT KERAMIK

Design **Giorgio Cattelan**

Tavolo con base in acciaio verniciato gofrato bianco, graphite, nero o inox satinato. Piano in ceramica Marmi Calacatta, Alabastro o Ardesia.

Table with base in white, black or graphite embossed lacquered steel or in satin stainless steel. Marmi Calacatta, Alabastro or Ardesia ceramic top.

Table avec base en acier laqué gaufré blanc, noir, graphite mat ou inox satiné. Plateau en céramique Marmi Calacatta, Alabastro ou Ardesia.

Mesa con base en acero barnizado gofrado blanco, negro, graphite o inox satinado. Sobre en cerámica Marmi Calacatta, Alabastro o Ardesia.

Esstisch mit Basis in Edelstahl lackiert weiß, schwarz oder graphite gaufriert oder in Edelstahl gebürstet. Platte in Keramik Marmi Calacatta, Alabastro oder Ardesia.

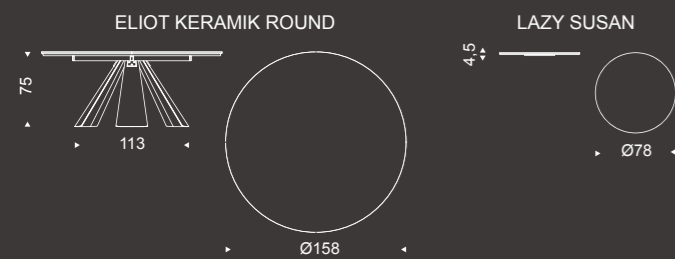
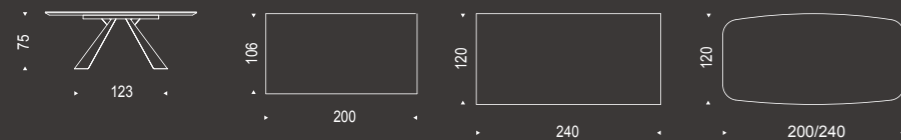

ELIOT KERAMIK DRIVE → EXTENDABLE TABLE pag. 186

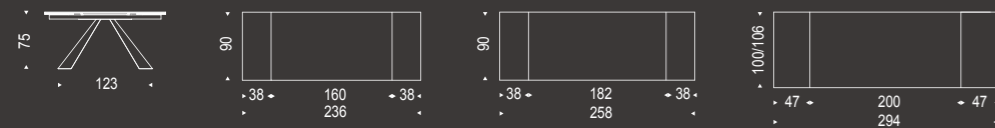



**ELIOT****Design Giorgio Cattelan**

Tavolo con base in acciaio verniciato goffrato bianco, graphite, nero o inox satinato. Piano in cristallo 12mm extrachiaro verniciato bianco o graphite, extrachiaro acidato bianco o graphite, in marmo bianco Carrara o Emperador. Il piano in cristallo 240x120 ha spessore 15mm.

Table with base in white, black or graphite embossed lacquered steel or in satin stainless steel. 12mm top in white or graphite painted extra clear glass or white or graphite painted frosted extra clear glass or white Carrara or Emperador marble. 15mm glass top on 240x120 version.

Table avec base en acier gaufré verni blanc, noir, graphite ou inox mat. Plateau en verre 12mm extra-clair verni blanc ou graphite, extra-clair dèpoli verni blanc ou graphite, en marbre blanc Carrara ou Emperador. Version 240x120 épaisseur 15mm.

Mesa con base en acero barnizado gofrado blanco, negro, graphite o inox satinado. Sobre en cristal 12mm extraclaro barnizado blanco o graphite o extraclaro translúcido barnizado blanco o graphite, en mármol blanco Carrara o Emperador. El sobre en cristal 240x120 es de grosor 15mm.

Esstisch mit Basis in Edelstahl lackiert weiss, schwarz oder graphite gaufriert oder in Edelstahl gebürstet. Platte in Glas 12mm extra hell lackiert weiss oder graphite, Glas extra hell geätzt weiss oder graphite lackiert oder in weiss Carrara oder Emperador Marmor. Die Platte in der Größe 240x120 hat eine Dicke von 15mm.

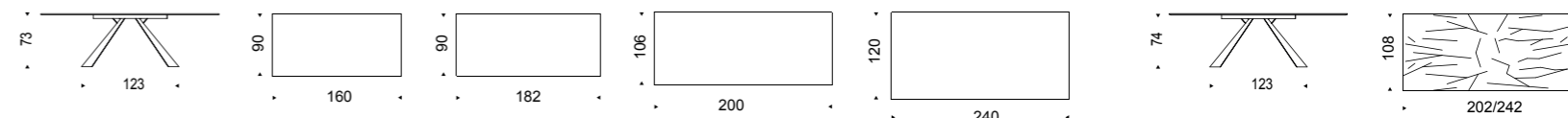

ELIOT DRIVE → EXTENDABLE TABLE pag. 190

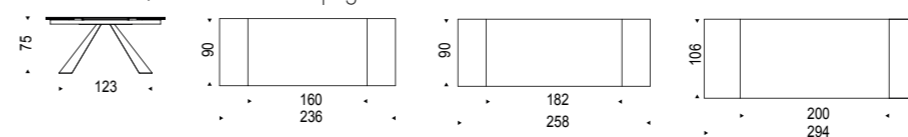



table ELIOT - chairs ANNA - lamps GALAXY - sideboard EUROPA - mirror REGAL FUMÉ - table lamp BOLERO - bookcase AIRPORT - rug HALIBUT

SIGMA**Design Philip Jackson**

Tavolo con base in metallo verniciato trasparente. Piano in noce Canaletto, rovere bruciato o rovere naturale con bordi irregolari in massello. A richiesta possibilità di posizionare le gambe in parallelo o perpendicolari fra loro.

Table with transparent varnished metal base. Top in Canaletto walnut, burned oak or natural oak with solid irregular edges. Legs can be placed in parallel or in perpendicular to each other on demand.

Table avec base en metal verni transparent. Plateau en noyer Canaletto, rouvre brulé ou rouvre naturel. Bords irréguliers. Possibilité de positionner les pieds en parallèle ou perpendiculaire entre eux sur demande.

Mesa con base en metal barnizado transparente. Sobre nogal Canaletto, roble ahumado o roble natural con bordes irregulares en macizo. Posibilidad de colocar las patas en paralelo o perpendiculares entre sí a pedido.

Tisch mit Basis aus Metall lackiert transparent. Platte aus Nussbaum Canaletto, "verbrannte Eiche" oder Natur Eiche mit massiven Kanten. Beine können entweder parallel oder senkrecht montiert werden auf Anfrage.

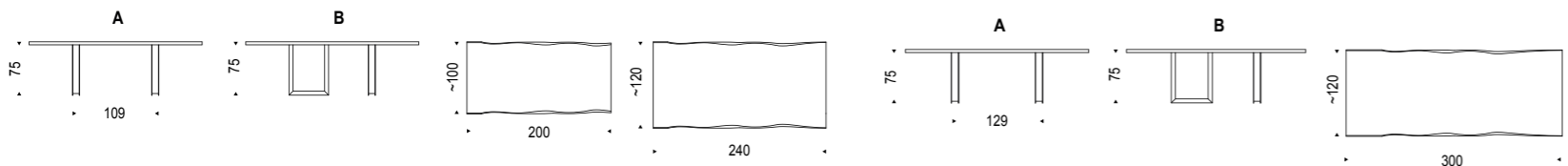

SIGMA DRIVE → EXTENDABLE TABLE pag. 196

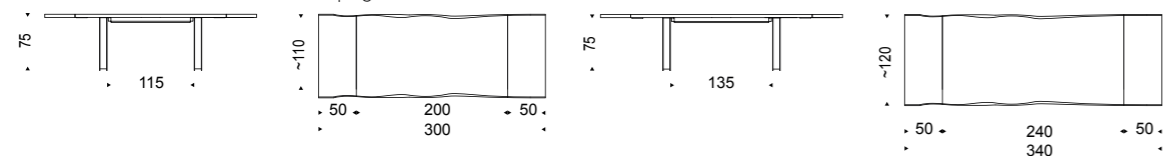

table SIGMA - chairs PATRICIA - sideboard TROPEZ - lamps CALIMERO - mirror JERSEY



DAYTONALMONDZED
 ELIOTWOODRIVELP
 HUGGEBISTROTFLAG
 MONAGODRIVEANNA
 MONTECARLOJEREZ
 HELENASABELMIA
 DOMINONEBRASKAU
 SMARTBALCONLARA
 MARGOTCALIMEROO
 ATOLLOASTRAARCR
 GHOSTMONDAYRAYO
 BOBBONGOHYATTRR
 PANDRAMAMATISSE
 VALENTINGELVISE
 VITAREGALZENIT
 RCORTINAYEKELAR
 LABYRINTHQWERTY
 ESTORILWINDOWTV
 HOUSTONPARSIFAL
 CARALITTLEFLAGM
 BILLYWOODFUTURA
 RISLANDTHRILLER
 AZIMUTCOBRAINOK

table SIGMA (Canaletto walnut) - chairs TOSCA, MAGDA, ARCADIA, HELENA, MADGA B - lamps HUBLOT - mirror STRIPES - sideboard TORINO - table lamp MEDUSA - bookcase WALLY B

MONACO

Design Giorgio Cattelan

Tavolo con base in noce Canaletto, rovere bruciato, marmo bianco Carrara o acciaio inox. Piedi in acciaio inox lucido. Piano con piastre in cristallo trasparente temperato 15mm o in marmo bianco Carrara. Piano in marmo in appoggio.

Table with base in Canaletto walnut, burned oak, white Carrara marble or stainless steel. Feet in polished stainless steel. Top with plates in 15mm tempered clear glass or in white Carrara marble. The marble top is laid on the base.

Table avec base en noyer Canaletto, rouvre brûlé marbre blanc Carrara ou acier inox. Pieds en acier inox brillant. Top avec plates en verre clair trempé 15mm ou blanc Carrara. Plateau en marbre d'appui.

Mesa con base en nogal Canaletto, roble ahumado, blanco Carrara o acero inox. Patas en acero inox brillo. Sobre con pletinas en cristal transparente templado 15mm o en blanco Carrara. Sobre en mármol en apoyo.

Tisch mit Basis aus Nussbaum Canaletto, "verbrannte Eiche", weißem Carrara Marmor oder Edelstahl. Füße aus poliertem Edelstahl. Platte mit metalplättchen aus Sicherheitglas transparent 15mm oder in weißem Carrara Marmor. Marmor Platte auf dem Basis gelegt.

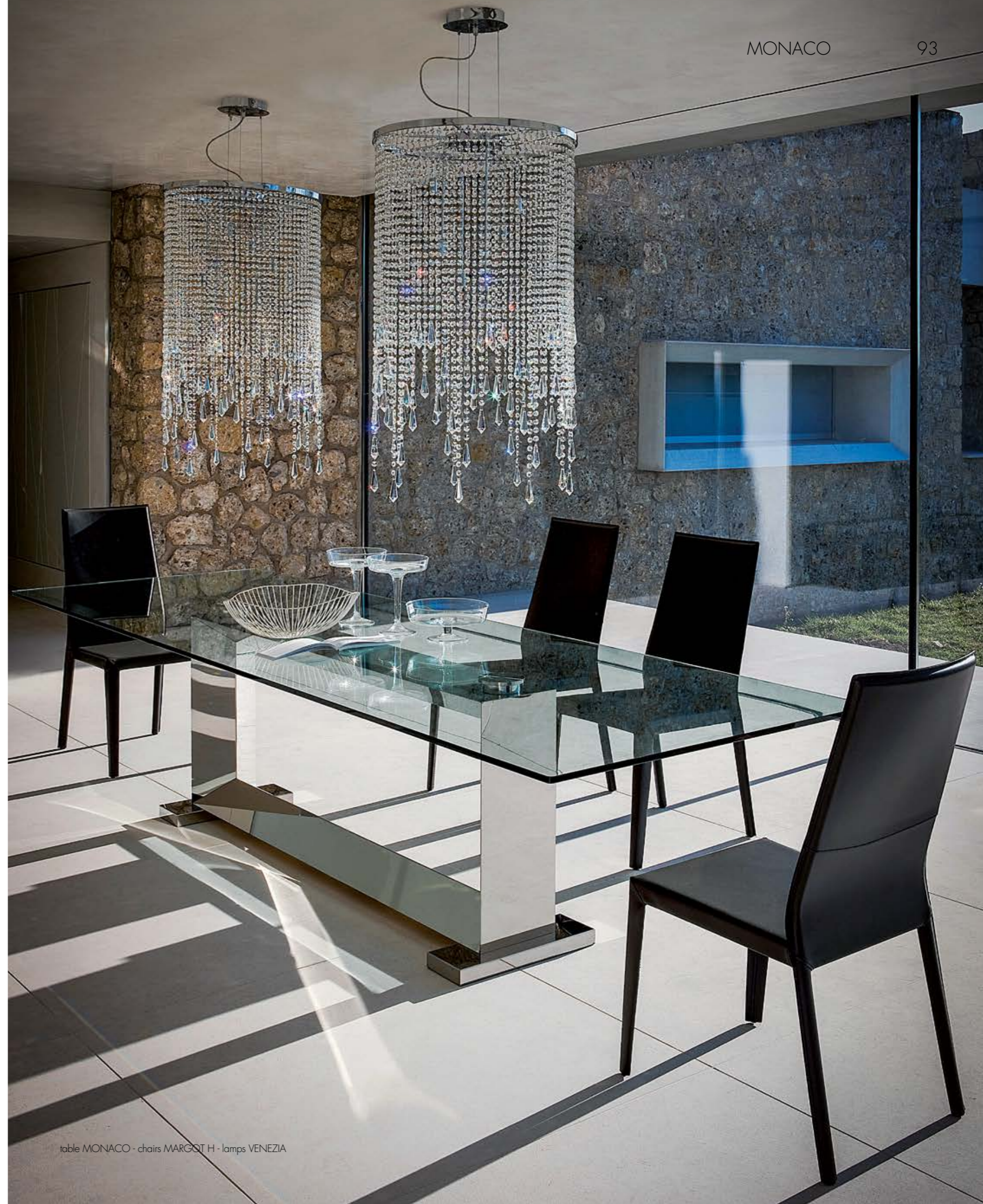
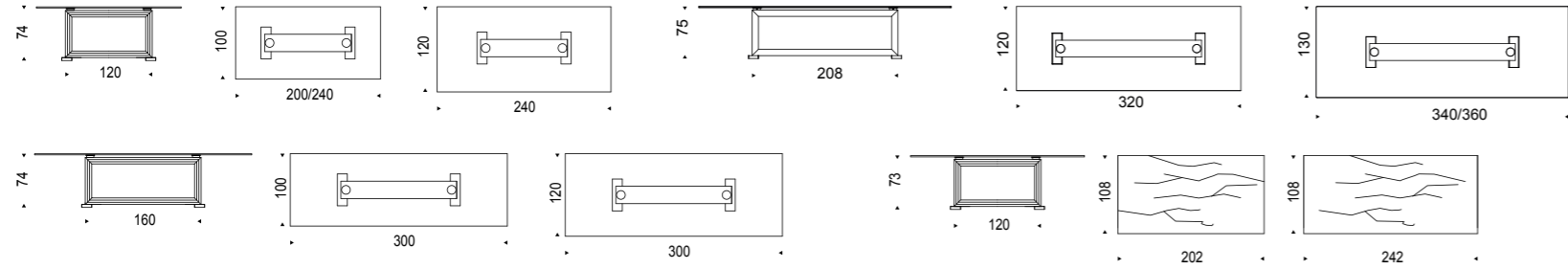

MONACO DRIVE pag. 198

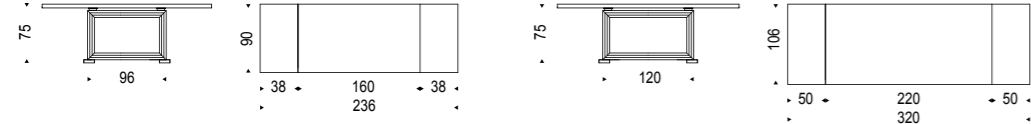

table MONACO - chairs MARGOT H - lamps VENEZIA



table MONACO - chairs ISABEL H - lamp OKTOPUS - sideboards PRISMA



base WAINUT CANALETTO



base WHITE CARRARA MARBLE





table MONACO - chairs AGATHA FLEX - suspension lamps HUBLOT - sideboard OXFORD - lamp PLUTO

CARIOCA

Design Andrea Lucatello

Tavolo con base in massello di noce Canaletto. Piano con piastre in cristallo 15mm trasparente o trasparente extrachiaro con bordo bisellato.

Table with base in solid Canaletto walnut wood. Top with plates in 15mm clear glass or extra clear bevelled glass.

Table avec base en noyer Canaletto massif. Plateau avec plates en verre, transparent ou extra-clair transparent biseauté 15mm.

Mesa con base de madera maciza en nogal Canaletto. Sobre con pletinas en cristal de 15mm transparente o transparente extrachiaro con borde biselado.

Esstisch mit Basis in Nussbaum Canaletto massiv. 15 mm Platte mit metalplättchen aus transparentem oder extra hell transparentem Glas mit facettierten Kanten.

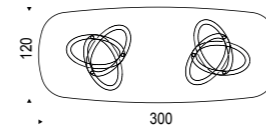
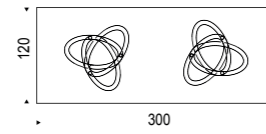
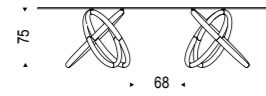
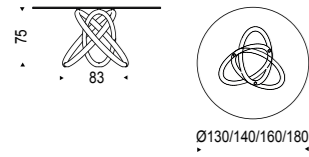



table CARIOCA - chairs SOFIA - lamps HUBLOT - shelves PENDOLA



GOBLIN
Design Modus Studio

Tavolo con base in massello di noce Canaletto. Piano in appoggio in cristallo trasparente 15mm. Il piano 200x106 ha spessore 12mm.

Table with base in solid Canaletto walnut. Top in 15mm clear and extra clear glass, laid on the base. 12mm glass top on 200x106 version.

Table avec piétement en noyer Canaletto. Plateau en appui en verre transparent ou extra-clair transparent 15mm. Version 200x106 épaisseur 12mm.

Mesa con base maciza en nogal Canaletto. Sobre en apoyo cristal transparente 15mm. El sobre 200x106 es de grosor 12mm.

Tisch mit Basis in Nußbaum Canaletto massiv. Gelegte Platte in Klarglas 15mm. Die Platte in der Größe 200x106 hat eine Dicke von 12mm.

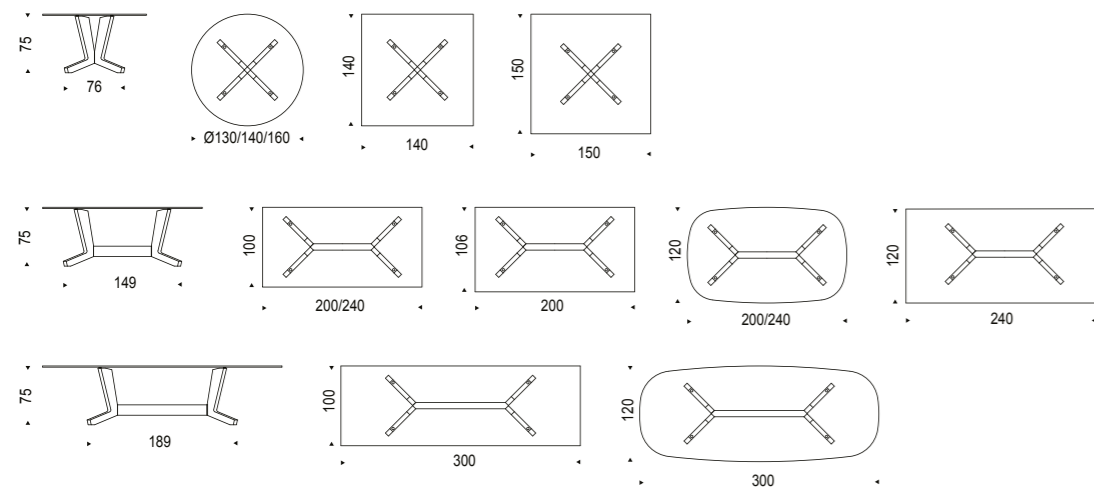

table GOBLIN - chairs ARCADIA H - lamps ECLIPSE - sideboard ARABESQUE





JEREZ**Design Alberto Danese**

Tavolo con base in acciaio verniciato goffrato bianco, nero o graphite e trave centrale in massello naturale di noce Canaletto o acciaio verniciato goffrato bianco, nero o graphite. Piano in cristallo trasparente o trasparente extrachiaro spessore 1.5mm. Piano in appoggio.

Table with base in white, black or graphite embossed lacquered steel and central beam in natural solid Canaletto walnut or embossed white, black, graphite lacquered steel. Top in 1.5mm clear or extra clear glass. The top is laid on the base.

Table avec base en acier gaufré verni blanc, noir ou graphite avec poutre centrale en bois de noyer Canaletto massif ou en acier gaufré verni blanc, noir ou graphite. Plateau en verre transparent ou extra-clair transparent, épaisseur 1.5mm.

Mesa con base en acero barnizado gofrado blanco, negro o graphite y viga central en macizo natural de nogal Canaletto o acero barnizado gofrado blanco, negro o graphite. Sobre en cristal transparente o transparente extrachiaro 1.5mm. Sobre en apoyo.

Esstisch mit Basis in Edelstahl lackiert weiss, schwarz oder graphite gaufriert und Holm aus massivem Natur Nussbaum Canaletto oder gaufriertem Stahl weiss, schwarz oder graphite. Platte in transparentem Glas oder Glas extra hell. Die Platte in 1.5mm ist auf die Basis gelegt.

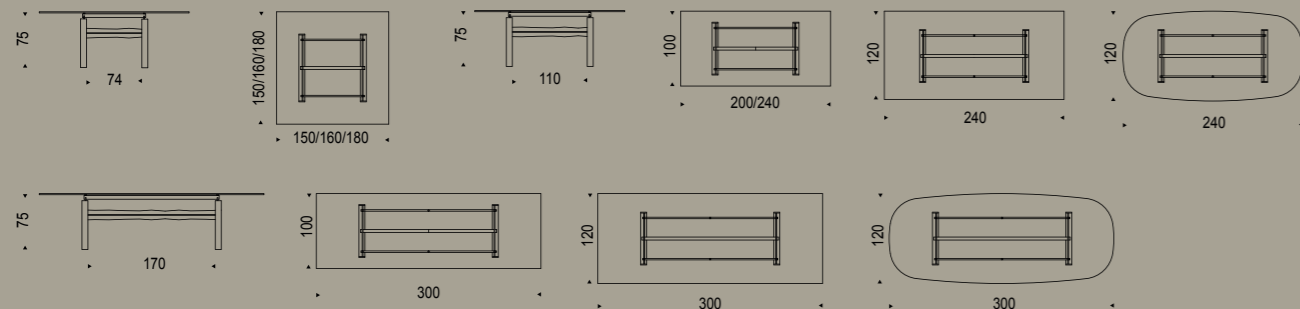

JEREZ DRIVE → EXTENDABLE TABLE pag. 206

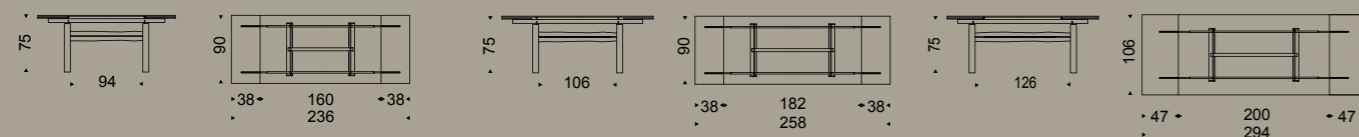



DOMINO**Design Andrea Lucatello**

Tavolo con base in massello di noce Canaletto o frassino finto rovere bruciato, mix noce-rovere o laccato a poro aperto in multicolor dall'oyster al graphite. Piano con piastre in cristallo trasparente o trasparente extrachiaro 12mm.

Table with base in solid Canaletto walnut wood or burned oak stained ashwood, mix walnut/oak or multicoloured open pore painting from oyster to graphite. Top with plates in 12mm clear or extra clear glass.

Table avec base en noyer Canaletto massif ou en frêne teinté rouvre brûlé, mix noyer-rouvre ou laqué pore-ouvert en multicolore de oyster jusqu'à graphite. Plateau avec plaques en verre transparent ou extra-clair transparent 12mm.

Mesa con base de madera en nogal Canaletto o fresno barnizado roble ahumado, mix nogal-roble o barnizado a poro abierto en multicolor de oyster a graphite. Sobre con pletinas en cristal de 12mm transparente o transparente extraclaro.

Esstisch mit Basis aus massiv Nussbaum-Canaletto oder Esche "verbrannte Eiche" gebeizt oder mix Nussbaum-Eiche oder offenporig lackiert in Multicolor oyster, graphite usw. Platte mit metalplättchen aus transparentem oder extra hell transparentem Glas 12mm.

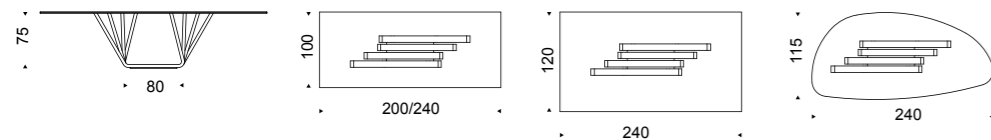

MUSEUM**Design G. Cattelan & A. Lucatello**

Tavolo con base in acciaio verniciato trasparente, ramato, gofrato bianco o graphite. Cilindro in marmo bianco Carrara o Travertino naturale. Piano in cristallo trasparente 15mm.

Table with base in transparent varnished steel, copper, embossed white or graphite lacquered steel. Cylinder in natural Travertine or white Carrara marble. 15mm clear glass top.

Table avec base en acier verni transparent, cuivre, gaufré blanc ou graphite et cylindre en marbre Travertin ou blanc Carrara. Plateau en verre clair 15 mm.

Mesa con base en acero barnizado transparente, cobre, gofrado blanco o graphite. Cilindro en mármol Travertino o blanco Carrara. Sobre en cristal 15mm transparente.

Esstisch mit Basis aus Metall lackiert transparent, verkupfert oder weiß oder graphite gaufriert. Zylinder aus Travertin oder weißem Carrara Marmor. Platte 15mm in Glas transparente.

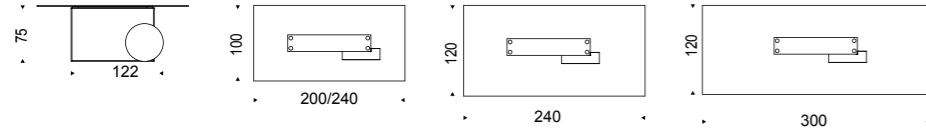



table MUSEUM - chairs MULAN - lamps MIDDAY - sideboard OXFORD 4

VALENTINO**Design Emanuele Zener**

Tavolo con base in noce Canaletto o rovere bruciato e cilindro in Travertino, black Marquina o white Carrara marble. Top in 15mm clear glass, laid on the base. The shaped top 240x115 is 12mm thick.

Table in Canaletto walnut or burned oak and cylinder in Travertine, black Marquina or white Carrara marble. Top in 15mm clear glass, laid on the base. The shaped top 240x115 is 12mm thick.

Table avec base en noyer Canaletto ou rouvre brûlé et cylindre en Travertin, marbre noir Marquina ou blanc Carrara. Les plateaux sont en verre clair placés sur la base épaisseur 15mm. Le plateau façonné en 240x115 a une épaisseur de 12mm.

Mesa con base en nogal Canaletto o roble ahumado. Cilindro en mármol Travertino, negro Marquina o blanco Carrara. Sobre en apoyo en cristal transparente de 15mm. El sobre 240x115 perfilado es 12mm.

Esstisch mit Basis aus Nussbaum Canaletto oder "verbrannte Eiche". Zylinder aus Travertin, schwarzem Marquina oder weißem Carrara Marmor. Platte aus Klarglas auf die Basis gelegt. Glas Stärke 15mm. Die gemodelte Platte 240x115 ist 12mm dick.

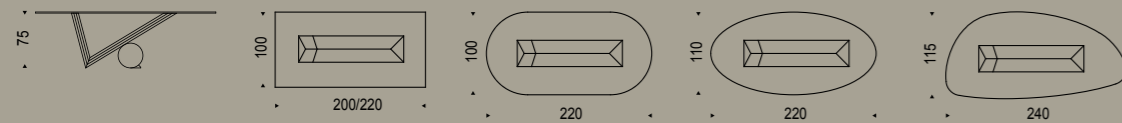



table VALENTINO - chair CAROL - lamp ZEPPELIN - sideboard KAYAK - mirror EXCALIBUR



VALENTINOX**Design Emanuele Zenero**

Tavolo con base in acciaio inox lucido. Cilindro in Travertino, marmo nero Marquina o bianco Carrara. Piani in appoggio in cristallo trasparente spessore 15mm. Il piano 240x115 sagomato ha spessore 12mm. Piccole irregolarità di riflessione sulla base sono dovute alla lavorazione manuale.

Dining table with polished stainless steel base and cylinder in Travertine, Black Marquina or white Carrara marble. Laying clear glass top 15 mm thick. The shaped top 240x115 is 12 mm thick. Small reflection's irregularities on the base are due to manual processing.

Table de repas avec base en acier inox brillant et cylindre en Travertin, marbre noir Marquina ou blanc Carrara. Les plateaux sont en verre clair placés sur la base épaisseur 15mm. Le plateau façonné en 240x115 a une épaisseur de 12mm. Les petites irrégularités de réflexion sur la base sont dues à une fabrication manuelle.

Mesa con base en acero inox brillo. Cilindro en mármol Travertino, negro Marquina o blanco Carrara. Sobre en apoyo en cristal transparente de 15mm. El sobre 240x115 perfilado es 12mm. Pequeñas irregularidad de reflexión en la base están causadas por la producción manual.

Esstisch mit Basis aus glänzendem Edelstahl. Zylinder aus Travertin, schwarzem Marquina oder weißem Carrara Marmor. Platte aus Klarglas auf die Basis gelegt. Glas Stärke 15mm. Die gemodelte Platte 240x115 ist 12mm dick. Kleine Unregelmäßigkeiten der Reflexion auf der Basis sind nicht zu vermeiden, da das Teil per Hand hergestellt wird.

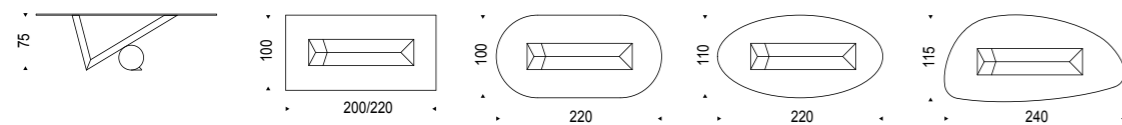

VIOLA D'AMORE**Design Piero De Longhi**

Tavolo con base in marmo bianco Carrara e cilindro in Travertino, marmo bianco Carrara o nero Marquina. Top in 15mm clear glass, laid on the base. Il piano 240x115 sagomato ha spessore 12mm.

Table with white Carrara marble base and cylinder in Travertine, white Carrara or black Marquina marble. Top in 15mm clear glass, laid on the base. The shaped top 240x115 is 12mm thick.

Table avec base en marbre blanc Carrara et cylindre en Travertin, blanc Carrara ou noir Marquina. Les plateaux sont en verre clair placés sur la base épaisseur 15mm. Le plateau façonné en 240x115 a une épaisseur de 12mm.

Mesa con base en mármol blanco Carrara. Cilindro en mármol Travertino, blanco Carrara o negro Marquina. Sobre en apoyo en cristal transparente de 15mm. El sobre 240x115 perfilado es 12mm.

Tisch mit Basis aus weißem Carrara Marmor. Zylinder aus Travertin, schwarzem Marquina oder weißem Carrara Marmor. Platte aus Klarglas auf die Basis gelegt. Glas Stärke 15mm. Die gemadelte Platte 240x115 ist 12mm dick.

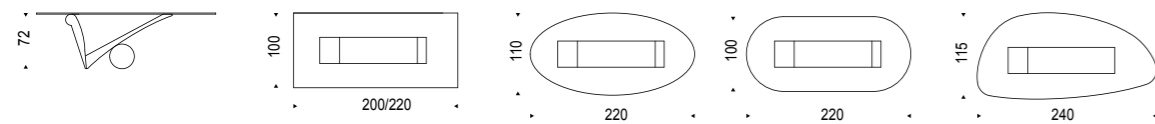

table VIOLA D'AMORE - chairs MAGDA - lamps CALIMERO - bookcases WALLY



DIAPASON**Design Studio Diapason**

Consolle con base in Travertino o bianco Carrara e piano in cristallo trasparente 15 mm. Piano in appoggio.

Console with Travertine or white Carrara marble base. Clear glassw 15 mm. The top is laid on the base.

Consolle avec base en Travertin ou blanc Carrara. Plateau en verre clair 15 mm. Plateau en appui.

Consola con base en mármol Travertino o blanco Carrara. Sobre en cristal transparente 15mm. Sobre en apoyo.

Konsole mit Fuß aus Travertin oder weiß Carrara Marmor. Klarglasplatte 15 mm auf dem Basis gelegt.

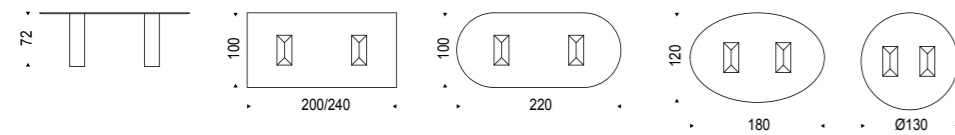

REEF**Design Piero De Longhi**

Tavolo con base in cristalplant bianco opaco. Piano in MDF bianco goffrato fine o bianco Carrara opaco.

Table with matt white cristalplant base. Top in white embossed MDF or matt white Carrara marble.

Table avec base en cristal plant blanc mat. Plateau en MDF gaufré blanc ou blanc Carrara mat.

Mesa con base en cristalplant blanco opaco. Sobre en MDF gofrado blanco o blanco Carrara opaco.

Tisch mit Basis aus Cristalplant matt weiss. Platte in gaufriertem weissem MDF oder matt weiss Carrara Marmor.

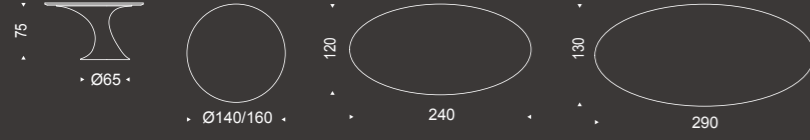

Carrara Marble



CORAL

Design **Andrea Lucatello**

Tavolo con base in poliuretano verniciato bianco. Piano con piastre in cristallo 15mm trasparente.

Table with white embossed polyurethane base. Top with plates in 15mm clear glass.

Table avec base en polyuréthane verni blanc. Plateau avec plaques en verre 15mm clair.

Mesa con base de poliuretano blanco gofrado. Sobre con pletinas en cristal 15mm transparente.

Esstisch mit Basis aus Polyurethan weiß gaufriert lackiert. Platte mit metalplättchen in Klarglas (15mm).



CORAL

133

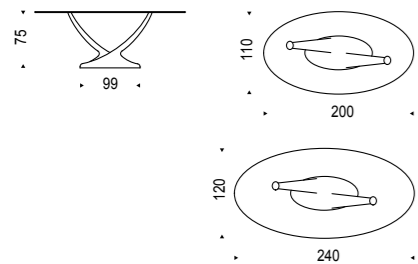

PLISSET**Design Raffaello Galotto**

Tavolo con base in marmo Palissandro bianco opaco. Piano in cristallo 15mm trasparente o trasparente extrachiaro. I piani 182x90 e 200x106 hanno spessore 12mm. I tavoli con 1 base hanno il piano in appoggio, con 2 basi hanno il piano in

Table with base in matt Palissandro white marble. Top in 15mm clear or extra clear glass. Glass top in 12mm on 182x90 and 200x106 versions. Top with plates in 1 base version, top laid on the base in 2 bases version.

Table avec base en marbre Palissandro blanc mat. Plateau en verre clair ou extra-clair 15 mm. Les plateaux 182x92 et 200x106 sont de 12 mm. Pour les tables avec une base, le plateau est avec platines et pour les tables avec deux bases le plateau est d'appui.

Mesa con base en mármol Palissandro blanco mate. Sobre en cristal 15mm transparente o transparente extraclaro. Los sobros 182x90cm y 200x106cm son de 12mm. Los sobros con 1 base tienen el sobre con las pletinas, los con 2 bases tienen sobre en apoyo.

Esstisch mit Basis im matt weiß Palissandro Marmor. Platte in 15 mm Glas transparent oder extra hell transparent. Platten in 182x90 und 200x106 sind in 12 mm Dicke. Tische mit einer Basis: die Platte hat die Metallplättchen; Tische mit 2 Basis: die Platte ist auf die Basis gelegt.

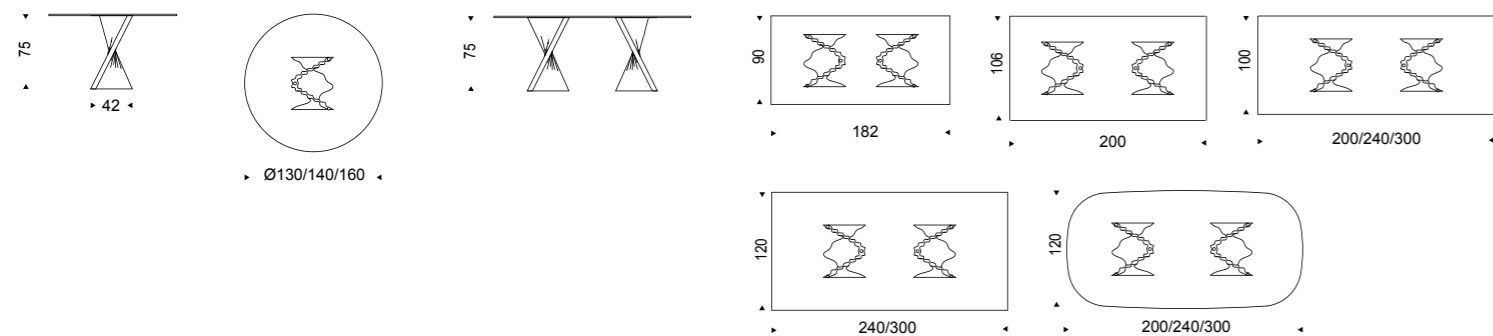



table PLISSET - chairs PATRICIA - lamp OKTOPUS - mirror TAXEDO - rugs MAPOON

**GIANO KERAMIK****Design Manzoni & Tapinassi**

Tavolo con base in acciaio verniciato
goffrato bianco, nero o graphite.
Piano in ceramica Marmi Calacatta,
Alabastro o Ardesia. Opzionale
centrotavola girevole lazy Susan.

Table with base in white, black
or graphite embossed, lacquered
steel. Marmi Calacatta, Alabastro
or Ardesia ceramic top. Opzionale
central swivelling tray lazy Susan.

Table avec base en acier gaufré
verni blanc, noir ou graphite. Plateau
en céramique Marmi Calacatta,
Alabastro ou Ardesia. Opionnel
plateau central pivotant lazy Susan.

Mesa con base en acero barnizado
gofrado blanco, negro o graphite.
Sobre en cerámica Marmi
Calacatta, Alabastro o Ardesia.
Opicional bandeja sobremesa
giratoria lazy Susan.

Esstisch mit Basis in Stahl lackiert
weiß, schwarz oder graphit gaufré.
Platte in Keramik Marmi Calacatta,
Alabastro oder Ardesia. Opicional
drehbare Tablette lazy Susan.



GIANO**Design Manzoni & Tapinassi**

Tavolo con base in acciaio verniciato gofrato bianco, nero o graphite. Piano in legno noce Canaletto, rovere bruciato o in marmo bianco Carrara opaco. Optional vassoio centrotavola girevole in cristallo extrachiaro acidato verniciato bianco, nero o graphite.

Table with base in white, black or graphite embossed lacquered steel. Top in matt white Carrara marble or Canaletto walnut or burned oak wood. Optional central swivelling tray in white, black or graphite painted extra clear frosted glass.

Table avec base en acier gaufré verni blanc, noir ou graphite. Plateau en noyer Canaletto, rouvre brûlé ou en marbre blanc Carrara mat. Optionnel plateau central pivotant en verre extra-clair dépoli verni blanc, noir ou graphite.

Mesa con base en acero barnizado gofrado blanco, negro o graphite. Sobre en madera nogal Canaletto, roble ahumado o en mármol blanco Carrara mate. Opcional bandeja sobremesa giratoria en cristal extraclaro translúcido barnizado blanco, negro o graphite.

Esstisch mit Basis in Stahl lackiert weiß, schwarz oder graphit lackiert. Platte in Nussbaum Canaletto, "verbrannte Eiche" oder in matt weiß Carrara Marmor. Optional drehbare Tablett in Glas extra hell geätzt weiß, schwarz oder graphit lackiert.

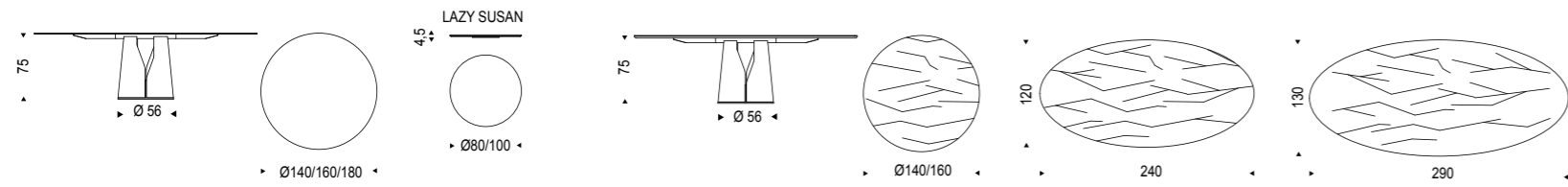

table GIANO - chairs MAGDA B



table GIANO marble Carrara - chairs BETTY - lamp OKTOPUS

SKORPIO ROUND

Design **Andrea Lucatello**

Tavolo con base in acciaio verniciato trasparente, gofrato bianco, nero o graphite. Piano in legno noce Canaletto o rovere bruciato, in cristallo trasparente o trasparente extrachiaro con bordo bisellato 15mm. Optional vassoio centratavola girevole in cristallo extrachiaro acidato verniciato bianco, nero o graphite.

Table with transparent varnished metal base, white, black or graphite embossed lacquered steel. Top in Canaletto walnut or burned oak, in clear or extra clear glass with bevelled 15mm edges. Optional central swivelling tray in white, black or graphite painted extra clear frosted glass.

Table avec base en acier verni transparent, gaufré blanc, noir ou graphite. Plateau en bois noyer Canaletto ou rouvre brûlé, verre clair ou extra-clair avec bord biseauté 15 mm. Optionnel: plateau central pivotant en verre extra-clair acidé verni blanc, noir ou graphite.

Mesa con base en acero barnizado transparente, gofrado blanco, negro o graphite. Sobre madera nogal Canaletto o roble ahumado, en cristal transparente o transparente extrachiaro con borde biselado 15mm. Opcional bandeja centro mesa giratoria en cristal extrachiaro translúcido barnizado blanco, negro o graphite.

Esstisch mit Basis aus Metall lackiert transparent, oder weiß, schwarz oder graphit lackiert transparent, oder weiß, schwarz oder graphit gaufriert. Platte in Nussbaum Canaletto, "verbrannte Eiche", Glas transparent oder Glas extra hell transparent mit Kanten facettiert 15 mm Dicke. Optional drehbare Tablette in Glas extra hell geätzt lackiert weiß, schwarz oder graphit.

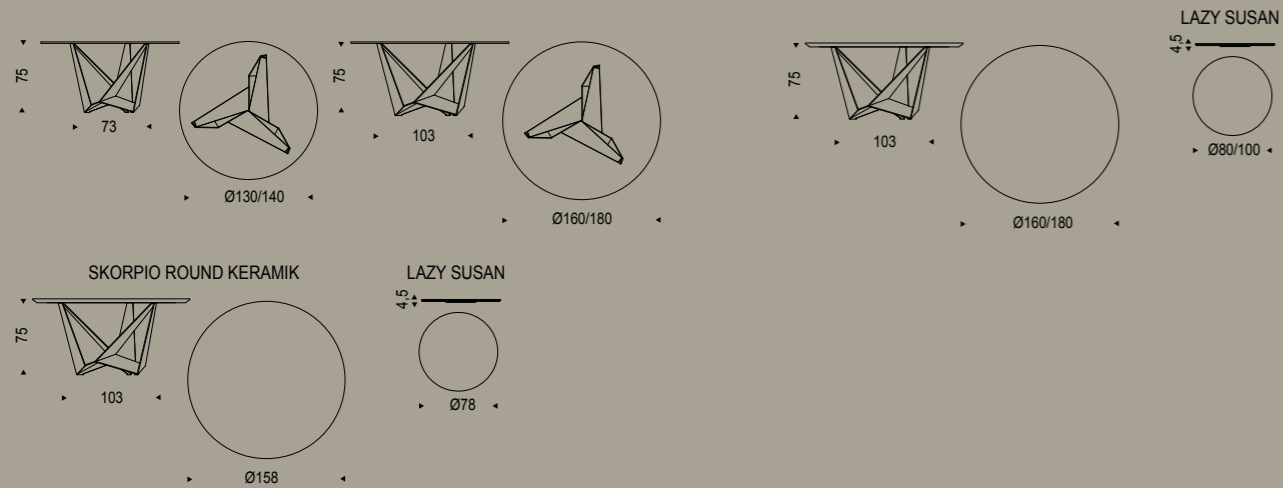

table SKORPIO ROUND - chairs MAGDA B - lamps HUBLOT



table SKORPIO ROUND - chair MAGDA B - lamp BOLERO

ELIOT ROUND

Design **Giorgio Cattelan**

Tavolo con base in acciaio verniciato gofrato bianco, nero, graphite o inox satinato. Piano in cristallo 15mm extrachiaro acidato verniciato bianco o graphite, in marmo bianco Carrara o Emperador, in noce Canaletto o rovere bruciato. I piani in marmo sono composti da quattro spicchi. Opzionale vassoio centrotavola girevole in cristallo extrachiaro acidato verniciato bianco, nero o graphite o marmo bianco Carrara o Emperador.

Table with base in white, black or graphite embossed lacquered steel or in satin stainless steel. 15mm top in white or graphite painted extra clear frosted glass or white Carrara, Emperador marble, Canaletto walnut or burned oak. Marble tops are composed of four segments. Optional central swivelling tray in white, black or graphite painted extra clear frosted glass or white Carrara or Emperador marble.

Table avec base en acier inox mat ou gaufré verni blanc, noir ou graphite. Plateau en verre 15mm extra-clair dépoli verni blanc ou graphite, en marbre blanc Carrara ou Emperador, en noyer Canaletto ou rouvre brûlé. Dessus de marbre sont composés de quatre segments. Optionnel plateau central pivotant en verre extra-clair acidé verni blanc, noir ou graphite ou marbre blanc Carrara ou Emperador.

Mesa con base en acero barnizado gofrado blanco, negro o graphite o inox satinado. Sobre en cristal 15mm extraclaro translúcido barnizado blanco o graphite, en mármol blanco Carrara o Emperador, en nogal Canaletto o roble ahumado. Los sobres de mármol se componen de cuatro segmentos. Opcional bandeja sobremesa giratoria en cristal extraclaro translúcido barnizado blanco, negro o graphite o mármol blanco Carrara o Emperador.

Esstisch mit Basis aus Edelstahl lackiert weiß, schwarz oder graphite gaufriert oder aus Edelstahl gebürstet. Platte in 15mm Glas extra hell geätzt weiß oder graphite lackiert, aus weiß Carrara oder Emperador Marmor, Nussbaum Canaletto oder "verbrannte Eiche". Die Marmorplatten sind aus vier Segmenten zusammengesetzt. Optional drehbare Tablette in Glas extra hell lackiert geätzt weiß, schwarz oder graphite, weiß Carrara oder Emperador Marmor.

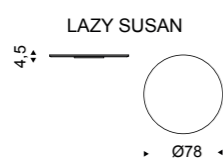
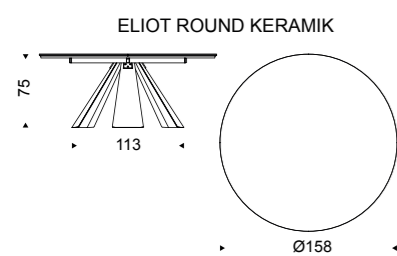
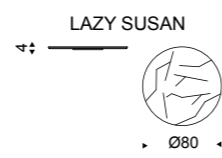
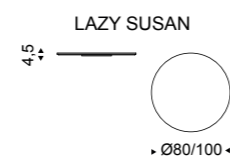
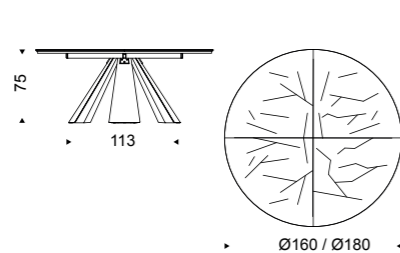
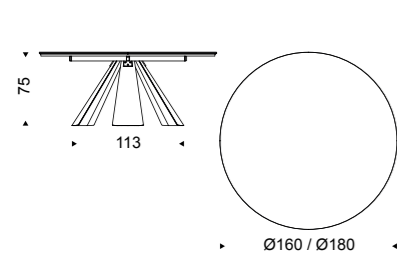

marble EMPERADOR





table ELIOT ROUND + lazy susan - chairs AURELIA - lamp VENEZIA



table ELIOT ROUND + lazy susan - chairs LULU - lamp ZEPPELIN

RAY**Design Paolo Cattelan**

Tavolo con gambe in acciaio verniciato bianco o graphite opaco, cromato, cromo nero o rivestite in cuoio come da campionario. Piano in cristallo trasparente temperato 15mm.

Table with base in chromed steel, black chrome or painted matt white, matt graphite or covered in leather as per sample card. Top in 15mm tempered clear glass.

Table avec piétement en acier laqué blanc matt, graphite matt, acier chromé ou chrome noir ou cuir selon échantillons. Plateau en verre clair trempé 15mm.

Mesa con patas en acero barnizado blanco o graphite opaco, cromado o cromo negro o revestidas en cuero según muestrario. Sobre en cristal transparente templado 15mm.

Esstisch mit Beine aus Stahl lackiert weiss matt, graphite matt, verchromtem oder schwarz chrom Stahl oder mit Kernlederbezug laut Musterkarte. Platte aus Klarglas 15mm Sicherheit.

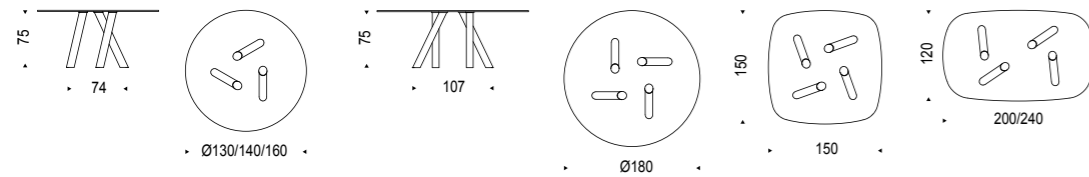

table RAY - chairs ANNA - lamp BOLERO



CORTINA

Design Pierluigi Stella

Tavolo con base in acciaio inox o noce Canaletto e acciaio inox o rovere bruciato e acciaio inox. Piano con piastre in cristallo trasparente 15mm.

Table with base in stainless steel or Canaletto walnut and stainless steel or burned oak and stainless steel. Top with plates in 15mm clear glass.

Table avec base en acier inox ou noyer Canaletto et acier inox ou rovere brûlé et acier inox. Plateau avec plates en verre transparent 15mm.

Mesa con base en acero inox o madera nogal Canaletto y acero inox. Sobre con pletinas en cristal transparente 15mm.

Tisch mit basis entweder aus Edelstahl oder Nußbaumholz Canaletto und Edelstahl oder "verbrannte Eiche" und Edelstahl. Platte mit metalplättchen aus transparentem Glas 15mm.

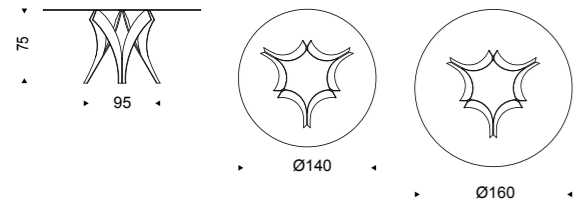

table CORTINA - chairs DAISY - lamps CALIMERO

BORA BORA

Design Giorgio Cattelan

Tavolo con base in alluminio verniciato gofrato bianco o graphite. Piano in noce Canaletto o rovere bruciato.

Table with base in white or graphite embossed lacquered aluminium. Top in Canaletto walnut or burned oak.

Table avec base en acier gaufré verni blanc ou graphite. Plateau en noyer Canaletto ou rovere brûlé.

Mesa con base en aluminio barnizado gofrado blanco o graphite). Sobre en nogal Canaletto o roble ahumado).

Esstisch mit Basis in Aluminium lackiert weiß oder graphit gaufriert. Platte in Nussbaum Canaletto oder "verbrannte Eiche".

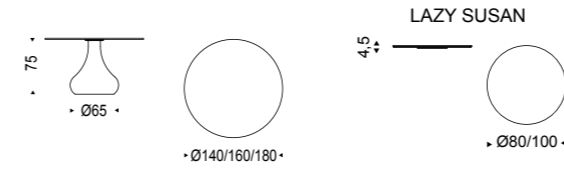

table BORA BORA - chairs TOSCA - lamp VENEZIA - sideboard NEBRASKA - mirror REBUS - table lamp BOLERO - showcase SABA

PEDRO**Design Pierluigi Stella**

Tavolo con base in acciaio verniciato bianco o graphite opaco, con o senza profili in acciaio inox. Piano in postformato laminato bianco opaco, laminato porfido grigio, laminato ossido grigio, laminato olmo bianco.

Table with base in matt white or graphite painted steel with or without profile in stainless steel. Top in matt white postformed, grey porphyry, grey oxide, white elm laminated wood.

Table avec base en acier laqué blanc ou graphite mat, avec ou sans profil en acier inox. Plateau postformés en laminé blanc mat, laminé porfido gris, laminé ossido gris, laminé orme blanc.

Mesa con base en acero barnizado blanco o graphite opaco, con o sin perfil en acero inox. Sobre en postformada laminado blanco opaco laminado porfido gris, laminado óxido gris, laminado olmo blanco.

Esstisch mit Basis aus Edelstahl lackiert in matt weiß oder matt graphite, mit oder ohne Profilen aus Edelstahl. Platte aus postforming matt weiß Laminat, Laminat grau Porphy, Laminat grau Oxid oder Laminat Ulme weiß.

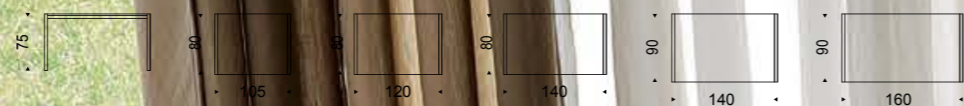

PEDRO DRIVE → EXTENDABLE TABLE pag. 242

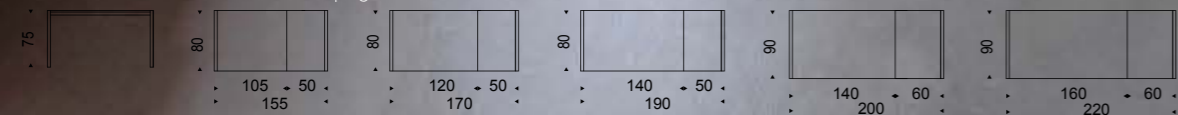



BASE WHITE / TOP WHITE



BASE INOX - WHITE / TOP OLMO



BASE INOX - WHITE / TOP OSSIDO



BASE INOX - GRAPHITE / TOP OSSIDO



BASE INOX - GRAPHITE / TOP OLMO



BASE GRAPHITE / TOP PORFIDO

ELVIS WOOD

Design Alberto Danese

Tavolo con base in acciaio inox o verniciato gofrato bianco o graphite. Piano in noce Canaletto, rovere bruciato o rovere naturale.

Versione "S" con bordi irregolari in massello in noce Canaletto, rovere bruciato o rovere naturale spessore 4 cm.

Versione "A": piano con bordi obliqui in noce Canaletto, rovere Heritage o rovere naturale, spessore di 4 cm.

Table with base in white or graphite embossed lacquered steel or in stainless steel. Top in Canaletto walnut, burned oak or natural oak.

4 cm thick top **"S" version** with irregular solid wood edges in Canaletto walnut, burned oak or natural oak.

Version "A": top with angled edges in Canaletto walnut, Heritage oak or natural oak. Wooden top 4 cm.

Table avec base en acier verni blanc mat, graphite mat ou inox. Plateau en noyer Canaletto, rouvre brûlé ou rouvre naturel.

Version "S" avec bord irréguliers en bois massif noyer Canaletto, rouvre brûlé ou rouvre naturel en épaisseur 4 cm.

Version "A": plateau en noyer Canaletto, rouvre Heritage ou rouvre naturel avec bords biseauté, épaisseur 4 cm.

Mesa con base en acero inox o barnizado gofrado blanco o graphite. Sobre en nogal Canaletto, roble ahumado o roble natural.

Grosor sobre de 4 cm en la **versión "S"** en nogal Canaletto, roble ahumado o roble natural con bordes irregulares en maciso.

Versión "A": sobre en nogal Canaletto, roble Heritage o roble natural con bordes obliquos, con grosor 4 cm.

Esstisch mit Basis aus Edelstahl, Stahl lackiert weiß oder graphit gaufriert. Platte in Nussbaum Canaletto "verbrannte Eiche" oder Eiche natur.

Version "S" mit irregelmessigen Kanten in massives Holzes noce Canaletto oder verbrannte Eiche oder Eiche Natur. Dicke den Platten 4 cm.

Version "A": Platte in Nussbaum Canaletto, Eiche Heritage oder Natur Eiche mit schräge Kanten, 4 cm Dicke.

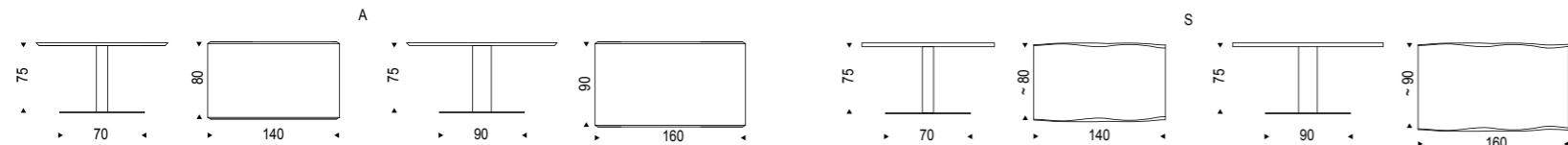

ELVIS WOOD DRIVE → EXTENDABLE TABLE pag. 182

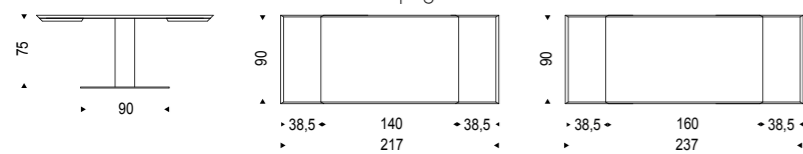

table ELVIS WOOD - A walnut canaletto



table ELVIS WOOD - S (natural oak) - chairs KAORI - lamp ZEPPELIN

ELVIS KERAMIK

Design Alberto Danese

Tavolo con base in acciaio inox o verniciato gofrato bianco o graphite. Piano in ceramica Laminam Fokos nei colori sale o piombo o ceramica Marmi Calacatta, Alabastro o Ardesia.

Table with base in white or graphite embossed lacquered steel or in stainless steel. Laminam Fokos ceramic top in salt or lead colours or in Marmi ceramic Calacatta, Alabastro or Ardesia.

Table avec base en acier laqué gaufré blanc, graphite ou inox brillant. Plateau en céramique Laminam Fokos dans les couleurs sel ou plomb ou céramique Marmi Calacatta, Alabastro ou Ardesia.

Mesa con base en acero inox o barnizado gofrado blanco o graphite. Sobre en cerámica Laminam Fokos colores sal, plomo o cerámica Marmi Calacatta, Alabastro o Ardesia.

Esstisch mit Basis aus Edelstahl oder Stahl lackiert weiß oder graphite gaufriert. Platte in Keramik Laminam Fokos in den Farben Salz oder Blei, oder Keramik Marmi Calacatta, Alabastro oder Ardesia.

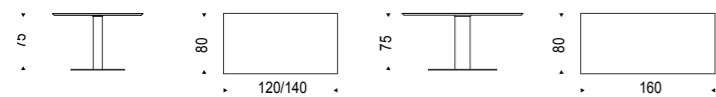

table ELVIS KERAMIK (Calacatta) - chairs PIUMA - lamps DREAM - sideboard LABYRINTH - mirror EXCALIBUR



ELVIS

Design Alberto Danese

Tavolo con base in acciaio inox o verniciato goffrato bianco o graphite. Piano in cristallo trasparente 15mm, in laminato grigio Londra Fenix o castoro Ottawa Fenix. Opzionale: prolunghe in acciaio inox solo per piani in cristallo 80 cm.

Table with base in white, graphite embossed lacquered steel or in stainless steel. Top in 15mm clear glass, grey London Fenix or beaver Ottawa Fenix laminated wood. Opzionale: stainless steel extensions only for glass top 80 cm.

Table avec base en acier laqué gaufré blanc, graphite ou inox brillant. Plateau en verre clair 15mm, en laminé gris Londres Fenix ou castor Ottawa Fenix. Opionnels: rallonges en acier seulement pour le plateau en verre 80 cm.

Mesa con base en acero inox o barnizado gofrado blanco o graphite. Sobre en cristal transparente 15mm, laminado gris Londres Fenix o castor Ottawa Fenix. Opcional: extensiones en acero solo por el sobre en cristal 80 cm.

Esstisch mit Basis aus Edelstahl oder Stahl lackiert weiß oder graphite gaufriert. Platte aus Klarglas transparent 15mm, laminiert grau Fenix London oder Biber Ottawa Fenix Laminat. Opzionale: edelstahl Verlängerungen nur für Glasplatte 80 cm.

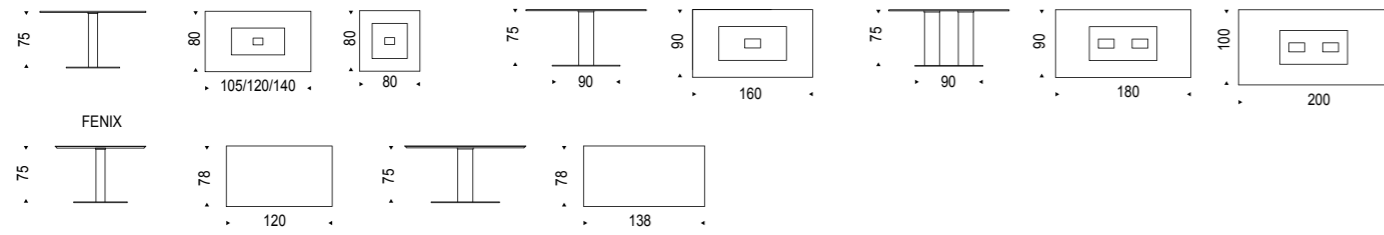

ELVIS DRIVE → EXTENDABLE TABLE pag. 251

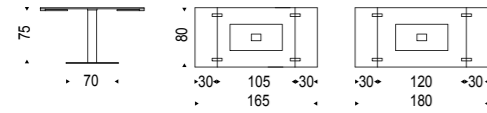

ELVIS WINGS → EXTENDABLE TABLE pag. 250

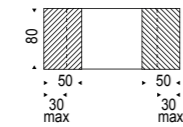

table ELVIS - chairs MULAN - lamps MIDDAY - sideboard DAKOTA - shelves PENDOLA - rug HALIBUT



table ELVIS - chairs KAORI - lamps CALIMERO and HUBLOT - sideboard KAYAK



OBELISCO**Design Oriano Favaretto**

Tavolo con base in acciaio inox o verniciato gofrato graphite. Gamba in cemento verniciato in pasta nei colori bianco o grigio. Piano con piastra in cristallo trasparente 15mm.

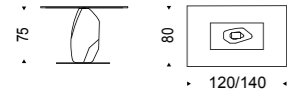

Table with base in stainless steel or graphite embossed lacquered steel. Leg in white or grey colored cement. 15mm clear glass top with plate.

Table avec base en acier inox brillant ou laqué gaufré graphite. Pied en ciment coloré blanc ou gris. Plateau en verre clair 15mm avec plaque.

Mesa con base en acero inox o barnizado gofrado graphite. Pata en cemento pintado blanco o gris. Sobre con placa en cristal transparente 15mm.

Esstisch mit Basis aus Edelstahl oder Stahl lackiert graphite gaufriert. Bein aus Zementleim in den Farben weiß oder grau. Platte mit Metallplättchen in Klarglas 15mm.

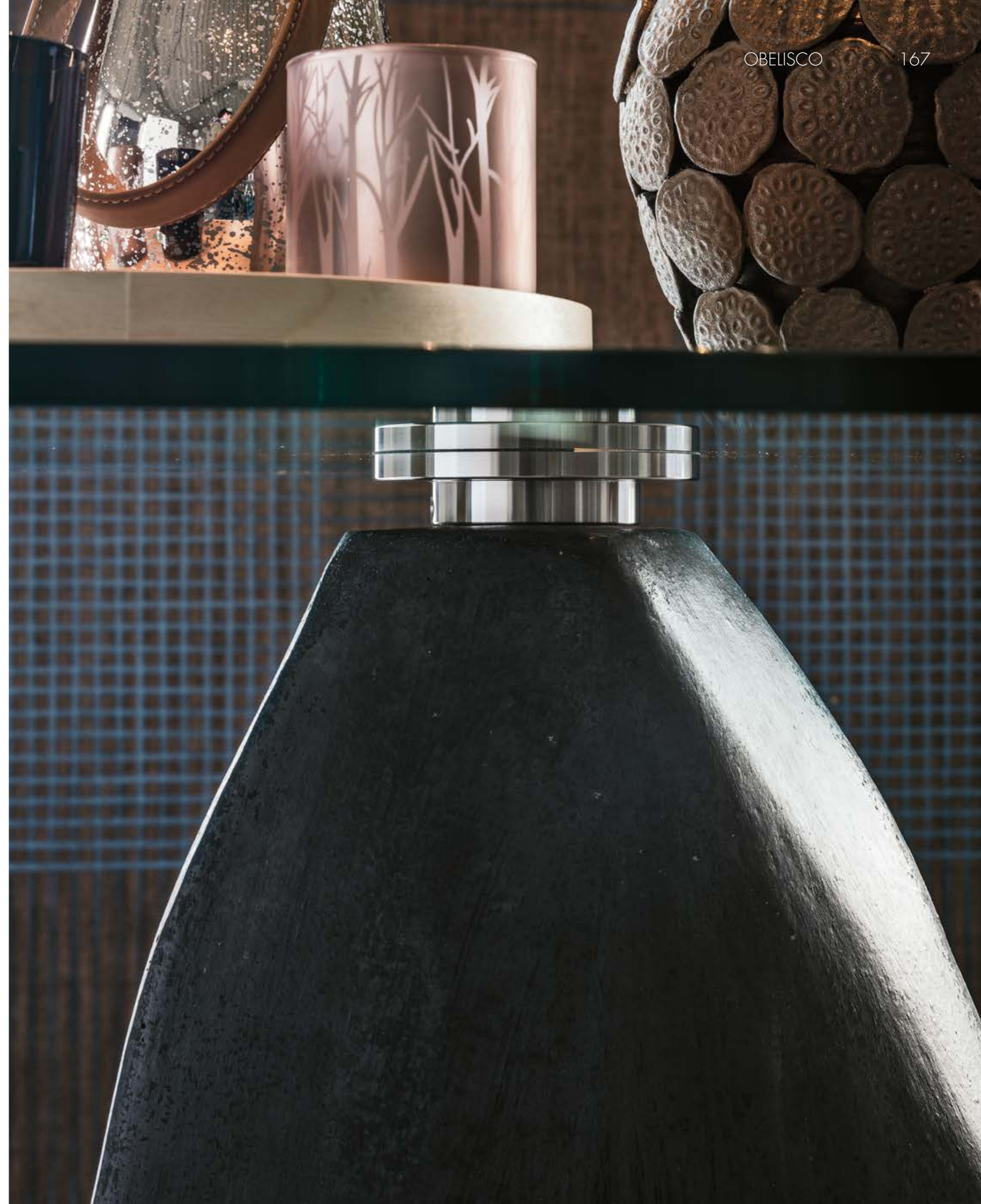



table OBELISCO - chairs KAORI - lamps APOLLO - sideboard DAKOTA

HUGO BISTROT**Design Philip Jackson**

Tavolo bistrot con base in poliuretano verniciato bianco o nero. Piano in cristallo trasparente 12mm o in MDF laccato bianco o nero opaco.

Bistrot table with white or black embossed polyurethane base. Top in 12mm clear glass or white or black lacquered MDF.

Table bistrot avec base en polyuréthane verni blanc ou noir. Plateau en verre clair 12mm ou en MDF laqué blanc ou noir.

Mesa bistrot con base en poliuretano pintado blanco o negro. Sobre en cristal transparente 12mm o MDF pintado blanco o negro.

Bistrot Tisch mit Basis aus lackiertem Polyurethan in den Farben weiß oder schwarz. Platte aus Klarglas 12mm oder aus lackiertem MDF weiß oder schwarz.

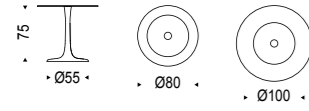

table HUGO BISTROT - chair NINA

HENRY**Design Silver Studio**

Tavolo bistrot con base in acciaio inox, colonna in acciaio cromato e piano in cristallo trasparente.

Bistrot table with base in stainless steel and chromed foot and top in clear glass.

Bistrot avec base en acier inox, pied chromé et top en verre clair.

Mesa bistrot con base en acero inox y pata cromada. Sobre en cristal transparente.

Bistrot Tisch mit Bein aus Edelstahl, Fußteller verchromt. Platte in klarem Glas.

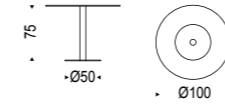

table HENRY - chairs ALESSIA

ROGER**Design Paolo Cattelan**

Tavolo con base in acciaio verniciato trasparente, goffrato bianco o graphite. Piano in legno noce Canaletto, rovere bruciato o in cristallo trasparente temperato 12 mm.

Table with transparent varnished metal base, white or graphite embossed lacquered steel. Top in Canaletto walnut, burned oak or 12 mm tempered clear glass.

Table avec base en acier laqué transparent, gaufré blanc ou graphite. Plateau en bois noyer Canaletto, rovere brûlé ou verre clair trempé 12 mm.

Mesa con base en acero barnizado transparente, gofrado blanco o graphite. Sobre en nogal Canaletto, roble ahumado o en cristal transparente templado 12 mm.

Esstisch mit Basis aus Metall lackiert transparent, weiß oder graphite gaufriert. Platte in Nussbaum Canaletto oder verbrannte Eiche oder transparentem Sicherheitsglas 12 mm.

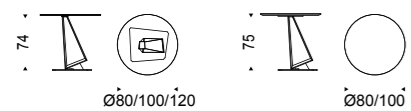

ROGER KERAMIK
Design Paolo Cattelan

Tavolo con base in acciaio verniciato trasparente, gofrato bianco o graphite. Piano in ceramica Marmi Calacatta, Alabastro o Ardesia.

Table with transparent varnished metal base, white or graphite embossed lacquered steel. Top in Marmi ceramic Calacatta, Alabastro or Ardesia.

Table avec base en acier laqué transparent, gaufré blanc ou graphite. Plateau en céramique Marmi Calacatta, Alabastro ou Ardesia.

Mesa con base en acero barnizado transparente, gofrado blanco o graphite. Sobre en cerámica Marmi Calacatta, Alabastro o Ardesia.

Esstisch mit Basis aus Metall lackiert transparent, weiß oder graphite gaufriert. Platte in Keramik Marmi Calacatta, Alabastro oder Ardesia.

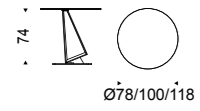

ceramic Alabastro



table ROGER KERAMIK (Alabastro) - chairs NINA - sideboard PRISMA - lamp BOLERO

BORA BORA BISTROT**Design Giorgio Cattelan**

Tavolo con base in alluminio verniciato gofrato bianco o graphite. Piano in MDF verniciato bianco, graphite opaco o impiallacciato con sezione di tronco d'albero di rovere. Le misure del piano in sezione di rovere sono indicative ed ogni pezzo è unico e diverso nella forma e nella misura.

Table with base in white or graphite embossed lacquered aluminium. MDF veneered top in log section of oak tree trunk or matt white or graphite painted MDF. Approximate sizes of the oak top, each piece is unique and different in shape and size.

Table avec base en acier gaufré verni blanc ou graphite. Plateau en MDF verni blanc mat, graphite mat ou plaqué avec une section de rovere. Les mesures du top en section de rovere sont indicatifs et chaque pièce est unique et différent dans la forme et la taille.

Mesa con base en aluminio barnizado gofrado blanco o graphite. Sobre en MDF barnizado blanco mate, graphite mate o contrachapado con sección de roble. Medidas del sobre en sección de roble indicativas, cada pieza es única y distinta en la forma y en las medidas.

Esstisch mit Basis aus Aluminium lackiert weiß gaufré oder graphit. Platte in MDF weiß lackiert, graphit matt oder furniert mit Heichebaumschnitt. Die angegebenen Massen bei der Version in furniert, sind Indikativ, da jeder Platte ist eine Unikat mit eigener Form und Größe.

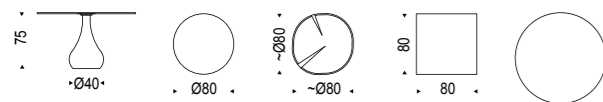

XOM KERAMIK**Design Paolo Cattelan**

Tavolo con base in acciaio verniciato gofrato bianco, nero o graphite oppure con base in acciaio verniciato gofrato bianco, nero o graphite inserti colonna in acciaio inox lucido e base in acciaio inox satinato. Piano in ceramica Marmi Calacatta, Alabastro o Ardesia.

Table with white, black or graphite embossed lacquered steel base or with white, black or graphite central leg and shiny stainless steel inserts, base in satin stainless steel. Top in Marmi ceramic Calacatta, Alabastro or Ardesia.

Table avec base en acier verni gaufré blanc, noir ou graphite ou colonne en acier verni gaufré blanc, noir ou graphite avec inserts colonne en acier inox et base en acier inox satiné. Plateau en céramique Marmi Calacatta, Alabastro ou Ardesia.

Mesa con base en acero barnizado gofrado blanco, negro o graphite o con columna central en acero barnizado gofrado blanco, negro o graphite cubierta parcialmente en acero inox lúcido y base en acero inox satinado. Sobre en cerámica Marmi Calacatta, Alabastro o Ardesia.

Esstisch mit Basis aus Metall lackiert weiß, schwarz oder graphite gaufriert oder mit Basis aus Metall lackiert weiß, schwarz oder graphite gaufriert, Spalte Einsätze aus glänzendem Edelstahl und Basis aus satiniertem Edelstahl. Platte in Keramik Marmi Calacatta, Alabastro oder Ardesia.

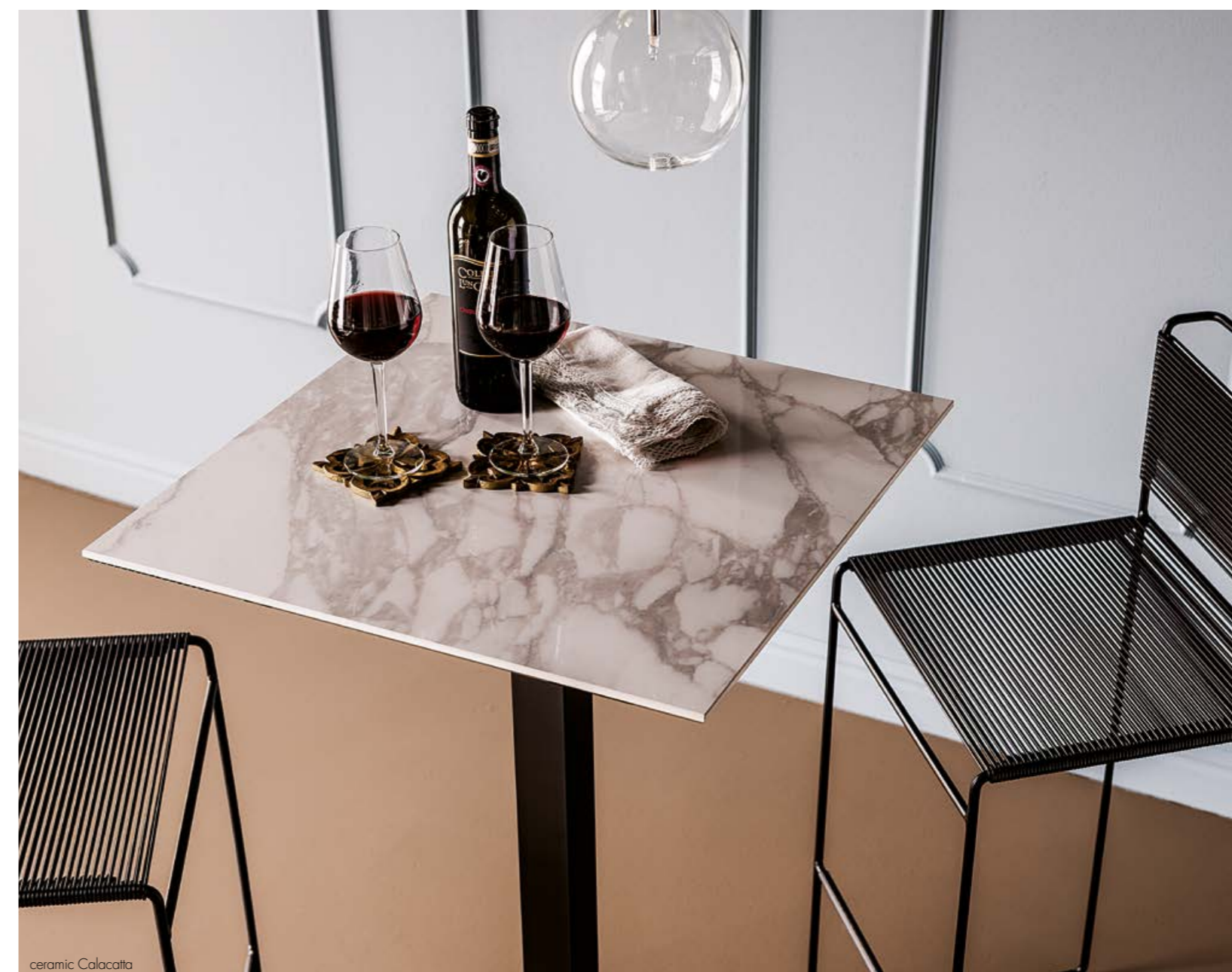
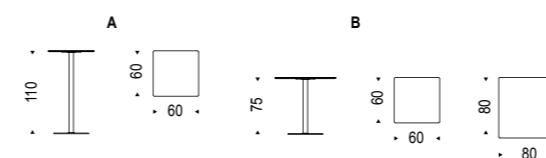

TAVOLI ALLUNGABILI_EXTENDIBLE TABLES



AZIMUT 218



BRERA 230



DAYTONA 222



DAYTONA ALMOND 226



ELAN DRIVE 200



ELIOT DRIVE 190



ELIOT KERAMIK DRIVE 186



ELIOT WOOD DRIVE 182



ELVIS DRIVE 251



ELVIS WINGS 250



ELVIS WOOD DRIVE 238



IKON DRIVE 192



JEREZ DRIVE 206



MONACO DRIVE 198



MONDAY 234



NEMO DRIVE 246



PEDRO DRIVE 242



SIGMA DRIVE 196



ZEUS DRIVE 212



ZEUS DRIVE KERAMIK 216

ELIOT WOOD DRIVE

Design Giorgio Cattelan

Tavolo allungabile con base in acciaio verniciato gofrato bianco, nero, graphite o inox satinato. Piano e prolunghe con bordi obliqui in legno noce Canaletto o rovere bruciato.

Extendible table with base in white, black or graphite embossed lacquered steel or in satin stainless steel. Top and extensions with angled edges in Canaletto walnut or burned oak.

Table à rallonges avec base en acier gaufré verni blanc, noir, graphite ou inox mat. Plateau et rallonges avec bords biseautés en noyer Canaletto ou rouvre brûlé.

Mesa extensible con base en acero barnizado gofrado blanco, negro, graphite o inox satinado. Sobre y extensiones con bordes oblicuos en madera nogal Canaletto o roble ahumado.

Ausziehbarer Esstisch mit Basis in Edelstahl lackiert weiss, schwarz oder graphite gaufriert oder in Edelstahl gebürstet. Platte und Verlängerungen mit schräge Kanten in Nussbaum Canaletto oder "verbrannte Eiche".

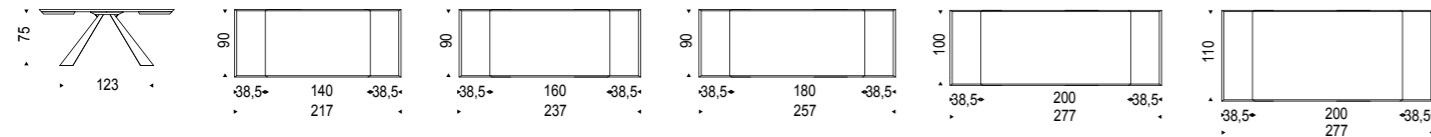

ELIOT WOOD pag. 76

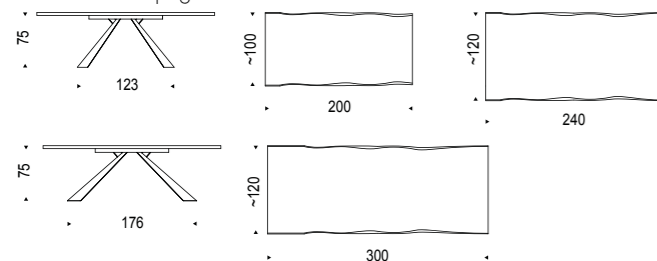



ELIOT KERAMIK DRIVE
Design **Giorgio Cattelan**

Tavolo allungabile con base in acciaio verniciato goffrato bianco, graphite o inox satinato. Piano e prolunghe in ceramica Laminam Fokos nei colori sale o piombo o ceramica Marmi Calacatta, Alabastro o Ardesia.

Extendible table with base in white or graphite embossed lacquered steel or in satin stainless steel. Laminam Fokos ceramic top and extensions in salt or lead colours or in Marmi ceramic Calacatta, Alabastro or Ardesia.

Table à rallonges avec base en acier laqué gaufré blanc, graphite ou inox satiné. Plateau et rallonges en céramique Laminam Fokos dans les couleurs sel ou plomb ou céramique Marmi Calacatta, Alabastro ou Ardesia.

Mesa extensible con base en acero barnizado gofrado blanco, graphite o inox satinado. Sobre y extensiones en cerámica Laminam Fokos colores sal o plomo o cerámica Marmi Calacatta, Alabastro o Ardesia.

Ausziehbarer Esstisch mit Basis in Edelstahl lackiert weiß, graphite gafriert oder in Edelstahl gebürstet. Platte und Verlängerungen in Keramik Laminam Fokos in den Farben Salz oder Blei oder Keramik Marmi Calacatta, Alabastro oder Ardesia.

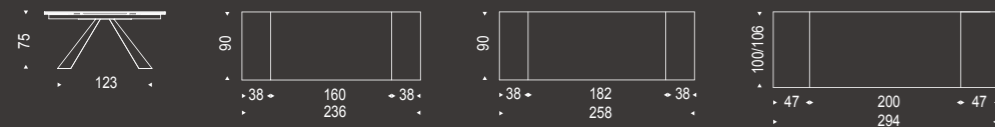

ELIOT KERAMIK pag. 80



table ELIOT KERAMIK DRIVE (ceramic Calacatta) - chairs ISABEL H - lamps BOLERO and ZEPPPELIN



ceramic Fokos piombo



ELIOT DRIVE**Design Giorgio Cattelan**

Tavolo allungabile con base in acciaio verniciato gofrato bianco, graphite o inox satinato. Piano e prolunghe in cristallo 12mm extrachiaro verniciato bianco o graphite o extrachiaro acidato bianco o graphite. Piano in appoggio.

Extendible table with base in white, graphite embossed lacquered steel or in satin stainless steel. Top and extensions in 12mm in white or graphite painted extra clear glass or white or graphite painted frosted extra clear glass.

Table à rallonges avec base en acier gaufré verni blanc, graphite ou inox mat. Plateau et rallonges en verre 12mm extra-clair verni blanc ou graphite ou extra-clair dépoli verni blanc ou graphite. Plateau en appui.

Mesa extensible con base en acero barnizado gofrado blanco, graphite o inox satinado. Sobre y extensiones en cristal 12mm extraclaro barnizado blanco o graphite o extraclaro translúcido barnizado blanco o graphite. Sobre en apoyo.

Ausziehbarer Esstisch mit Basis in Edelstahl lackiert weiss, graphite gaufriert oder in Edelstahl gebürstet. Platte und Verlängerungen in Glas extra hell geätzt und weiss oder graphite lackiert, oder in Glas extra hell geätzt und weiss oder graphite lackiert. Die Platte in 12mm ist auf die Basis gelegt.

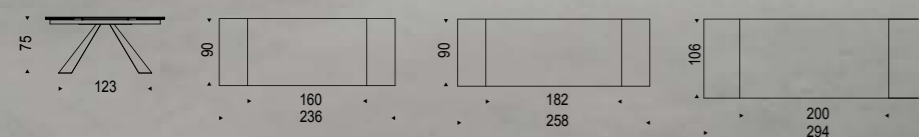
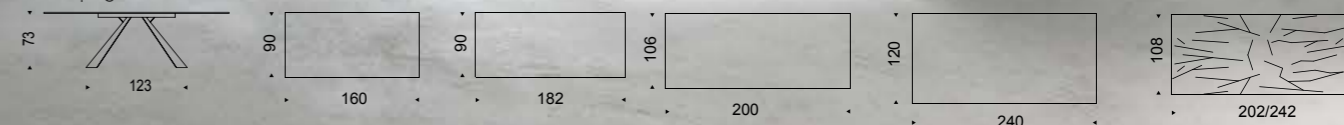

table ELIOT DRIVE - chairs PATRICIA

ELIOT pag. 84



IKON DRIVE

Design Philip Jackson

Tavolo allungabile con base in cristallo temperato extrachiaro trasparente 15mm e trave in graphite. Piano e prolunghe in noce Canaletto, rovere bruciato o rovere naturale con bordi irregolari in massello. Disponibile anche trave in noce Canaletto, rovere bruciato o rovere naturale.

Extendible table with 15mm extra clear tempered glass base and graphite beam. Top and extensions in solid Canaletto walnut, burned oak or natural oak with irregular solid wood edges. Available also Canaletto walnut, burned oak or natural oak beam.

Table à rallonges, piètement en verre trempé extra-clair transparent 15mm et traverse en graphite. Plateau et rallonges en noyer Canaletto, rovere brûlé ou rovere naturel. Bords irréguliers en bois massif. Traverse disponible aussi en noyer Canaletto, rovere brûlé ou rovere naturel.

Mesa extensible con base en cristal templado extraclaro transparente 15mm y viga en graphite. Sobre y extensibles en nogal Canaletto, roble ahumado o roble natural con bordes irregulares en macizo. Disponible también viga en nogal Canaletto, roble ahumado o roble natural.

Ausziehbarer Esstisch mit Basis aus 15mm extra hell transparentem gehärtetem Glas und Holm aus graphite. Platte und Verlängerungen aus Nussbaum Canaletto, "verbrannte Eiche" oder Natur Eiche mit massiven Kanten. Holm aus Nussbaum Canaletto, "verbrannte Eiche" oder Natur Eiche verfügbar.

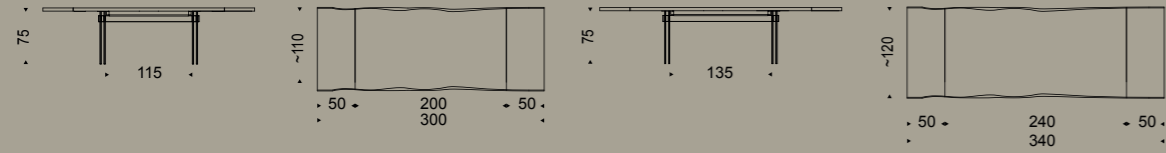

IKON pag. 66

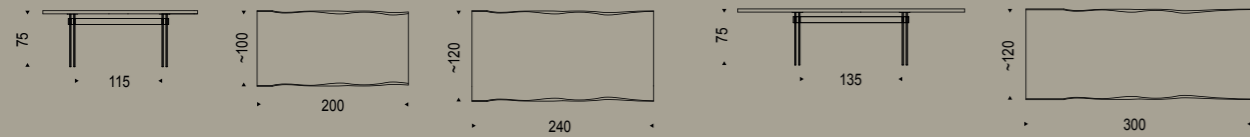



SIGMA DRIVE**Design Philip Jackson**

Tavolo allungabile con base in metallo verniciato trasparente. Piano e prolunghe in noce Canaletto, rovere bruciato o rovere naturale con bordi irregolari in massello.

Extendible table with transparent varnished metal base. Top and extensions in Canaletto walnut, burned oak or natural oak with solid irregular edges.

Table à rallonges avec base en métal verni transparent. Plateau et rallonges en noyer Canaletto, rovere brûlé ou rovere naturel, bords irréguliers.

Mesa extensible con base en metal barnizado transparente. Sobre y extensibles en nogal Canaletto, roble ahumado o roble natural con bordes irregulares en macizo.

Ausziehbarer Tisch mit Basis aus Metall lackiert transparent. Platte und Verlängerungen aus Nussbaum Canaletto, "verbrannte Eiche" oder Natur Eiche mit massiven Kanten.

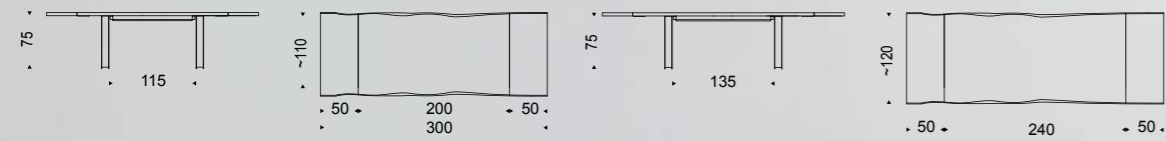

SIGMA pag. 88

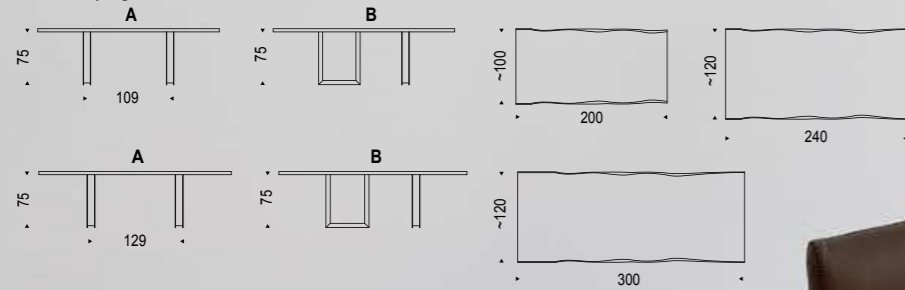

MONACO DRIVE

Design **Giorgio Cattelan**

Tavolo allungabile con base, piano e prolunghe in noce Canaletto, rovere bruciato. Piedi in acciaio inox lucido.

Extendible table with base, top and extensions in Canaletto walnut, burned oak. Feet in polished stainless steel.

Table à rallonges avec base, plateau et rallonges en noyer Canaletto, rouvre brûlé. Pieds en acier inox brillant.

Mesa extensible con base, sobre y extensiones en nogal Canaletto, roble ahumado. Patas en acero inox brillo.

Ausziehbarer Esstisch mit Basis, Platte und Verlängerungen aus Nussbaum Canaletto, "verbrannte Eiche". Füße aus glänzendem Edelstahl.

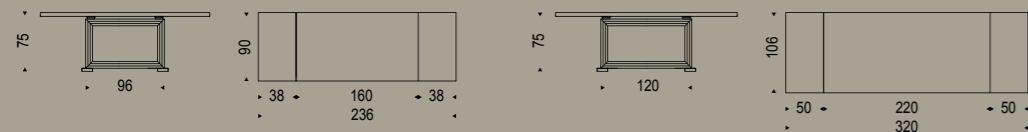

MONACO pag. 92

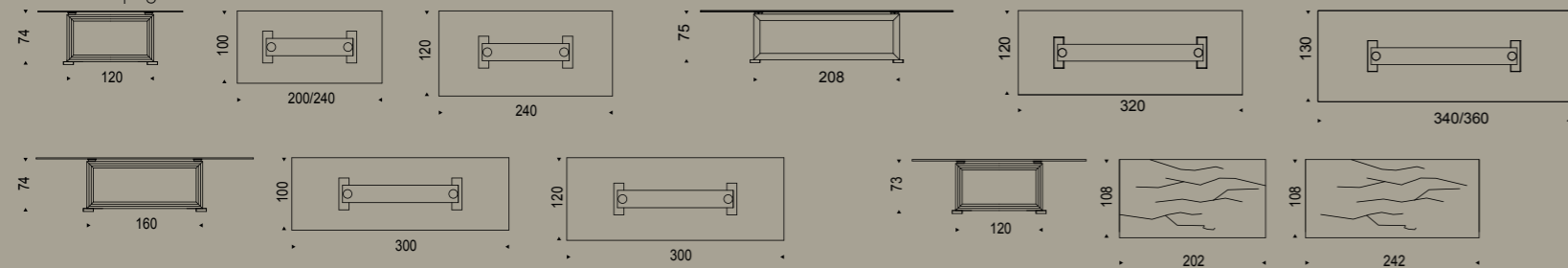

table MONACO DRIVE - chairs BRIGITTA - lamp VENEZIA



table MONACO DRIVE - chairs LADY - lamp VENEZIA

ELAN DRIVE
Design Paolo Cattelan

Tavolo allungabile con gambe in acciaio inox lucido o satinato o verniciato goffrato graphite o bianco. Binari in alluminio verniciato goffrato bianco o graphite o rivestiti in acciaio inox lucido o satinato con particolari verniciato goffrato graphite, bianco o nero. Piani e prolunghe in cristallo 12mm trasparente o trasparente extrachiaro. Piano in appoggio.

Extendible table with legs in shiny or satin stainless steel, graphite or white embossed lacquered steel. White or graphite embossed lacquered aluminum rails or in shiny or satin stainless steel with graphite, white or black embossed lacquered details. 12mm clear or extra clear glass top and extensions. The top is laid on the base.

Table à rallonges avec pieds en acier inox brillant ou satiné ou gaufré verni graphite ou blanc. Mécanisme en aluminium gaufré verni blanc ou graphite ou en acier inox brillant ou satiné avec détails gaufrés verni graphite, blanc ou noir. Top et rallonges en verre 12mm clair ou transparent extra-clair. Plateau d'appui.

Mesa extensible con patas en acero brillo o mate o en acero barnizado gofrado graphite o blanco. Mecanismo en aluminio barnizado gofrado blanco o graphite o en acero brillo o mate con detalles en barnizado gofrado graphite, blanco o negro. Sobre y extensiones en cristal 12mm transparente o transparente extraclaro. Sobre en apoyo.

Ausziehbarer Esstisch mit Beine aus Edelstahl glänzend oder satiniert oder aus Stahl lackiert gaufriert Graphit oder weiß. Schienen aus Aluminium lackiert gaufriert weiß oder Graphit oder in Edelstahl glänzend oder satiniert mit Einsätze lackiert gaufriert Graphit, weiß oder Schwarz. Platte und Verlängerungen in 12 mm Glass transparent oder extra hell transparent. Platte auf dem Basis gelegt.

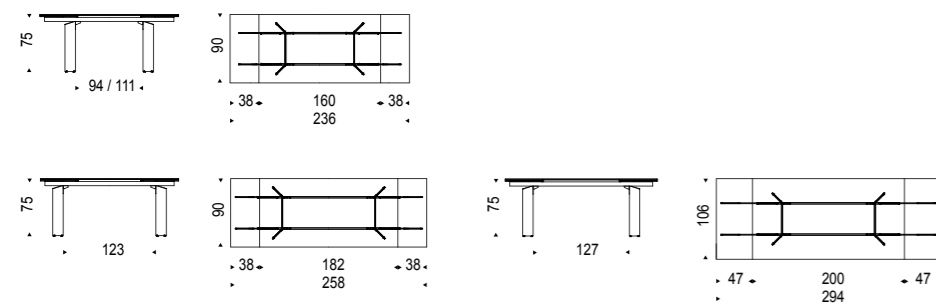





JEREZ DRIVE

Design Alberto Danese

Tavolo allungabile con base in acciaio e binari in alluminio verniciati gofrato bianco, nero o graphite. Trave centrale in massello naturale di noce Canaletto o acciaio verniciato gofrato bianco, nero o graphite. Piano e prolunghe in cristallo 12mm trasparente o trasparente extrachiaro. Piano in appoggio.

Extendible table with steel base and aluminum rails in white, black or graphite embossed lacquered. Central beam in natural solid Canaletto walnut or embossed white, black, graphite lacquered steel. Top and extensions in 12mm clear or extra clear glass. The top is laid on the base.

Table à rallonges avec base en acier et rails en aluminium gaufré verni blanc, noir ou graphite. Poutre centrale en bois de noyer Canaletto massif ou en acier gaufré verni blanc, noir ou graphite. Plateau et rallonges en verre transparent ou extra-clair transparent 12mm. Plateau en appui.

Mesa extensible con base en acero y mecanismo en aluminio barnizado gofrado blanco, negro o graphite. Viga central en macizo natural de nogal Canaletto o acero barnizado gofrado blanco, negro o graphite. Sobre y extensibles en cristal 12mm transparente o transparente extrachiaro. Sobre en apoyo.

Ausziehbarer Esstisch mit Basis aus Edelstahl und Schienen aus Aluminium lackiert weiss, schwarz oder graphite gaufriert. Holm aus massivem natur Nussbaum Canaletto oder gaufriertem Stahl weiß, schwarz oder graphite. Platte und Verlängerungen aus transparentem Glas oder Glas extra hell. Die Platte in 15mm ist auf die Basis gelegt.

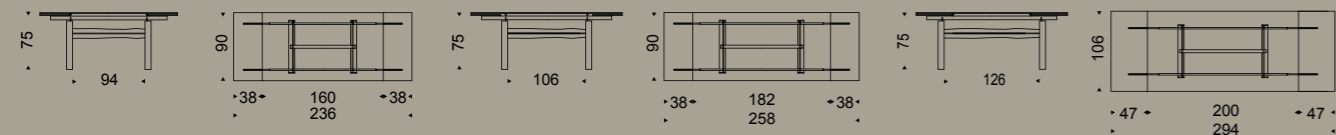

JEREZ pag. 110

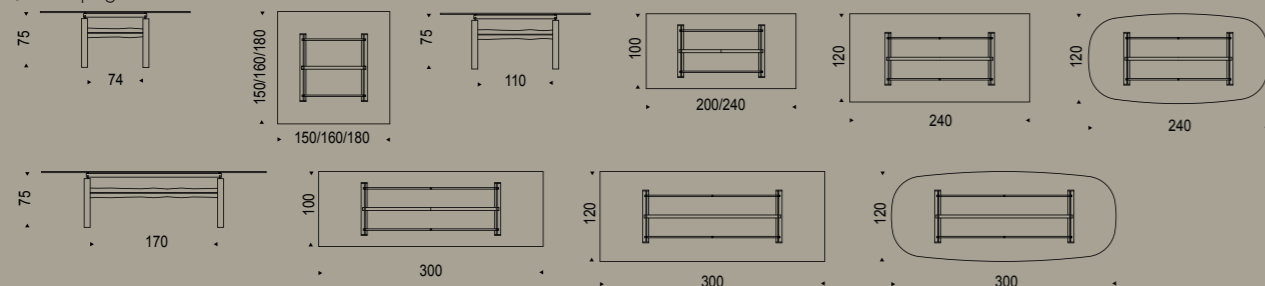





table JEREZ DRIVE - chairs ALESSIA - lamps GALAXY - mirror WISH BOARD

ZEUS DRIVE**Design Gilmo Crosara**

Tavolo allungabile con base e binario in acciaio verniciato gofrato bianco, graphite o nero. Piano e prolunghe in cristallo temperato 12mm trasparente, trasparente extrachiario o fumè.

Extendible table with base and rail in white, graphite or black embossed lacquered steel. Top and extensions in 12mm clear, extra clear or fumè tempered glass.

Table à rallonges avec base et rail en acier laqué gaufré blanc, graphite ou noir. Plateau et rallonges en verre clair, extra-clair ou fumè trempé 12mm.

Mesa extensible con base y mecanismo en acero barnizado gofrado blanco, graphite o negro. Sobre y extensibles en cristal templado 12mm transparente, transparente extraclaro o fumè.

Ausziehbarer Esstisch mit Basis und Schiene aus Edelstahl lackiert weiß, graphite oder schwarz gaufriert. Platte und Verlängerungen in Sicherheit 12 mm Glas transparent, extra hell transparent oder fumè.





ZEUS KERAMIK DRIVE

Design Gilmo Crosara

Extendible table with base and rail in white, graphite or black embossed lacquered steel. Top and extensions in Laminam Fokos ceramic in salt or lead colours or in Marmi ceramic Calacatta, Alabastro or Ardesia.

Table à rallonges avec base et rail en acier laqué gaufré blanc, graphite ou noir. Plateau et rallonges en céramique Laminam Fokos dans les couleurs sel ou plomb ou céramique Marmi Calacatta, Alabastro ou Ardesia.

Mesa extensible con base y mecanismo en acero barnizado gofrado blanco, graphite o negro. Sobre y extensiones en cerámica Laminam Fokos colores sal o plomo o cerámica Marmi Calacatta, Alabastro o Ardesia.

Ausziehbarer Esstisch mit Basis und Schiene aus Edelstahl lackiert weiß, graphite oder schwarz gaufriert. Platte und Verlängerungen in Keramik Laminam Fokos in den Farben Salz, Blei oder Keramik Marmi Calacatta, Alabastro oder Ardesia.



AZIMUT
Design Studio Kronos

Tavolo allungabile con gambe in cristallo curvato trasparente o trasparente extrachiario. Piano e prolunghe in cristallo trasparente o trasparente extrachiario temperato 15mm (prolunghe 12mm). Meccanismo in acciaio inox lucido e alluminio.

Extendible table with clear or extra clear curved glass legs. Top and extensions in 15mm tempered clear or extra clear glass (extensions 12mm). Mechanism in stainless steel and aluminium.

Table à rallonges avec pieds en verre clair ou extra-clair courbé. Plateau et rallonges en verre transparent ou extra-clair trempé 15mm (rallonges 12mm). Mécanisme de extension en acier inox et aluminium.

Mesa extensible con patas en cristal transparente o transparente extrachiario curvado. Sobre y extensiones en cristal transparente o transparente extrachiario templado 15mm (extensiones 12mm). Mecanismo en acero cromo y aluminio.

Ausziehbarer Esstisch mit gebogenen Füßen aus Klarglas oder extra hell Glas. Platte und Verlängerungen aus klarem oder extra hell Glas Sicherheit 15mm (Verlängerungen 12mm). Verlängerbares Gestell aus Edelstahl und Aluminium.

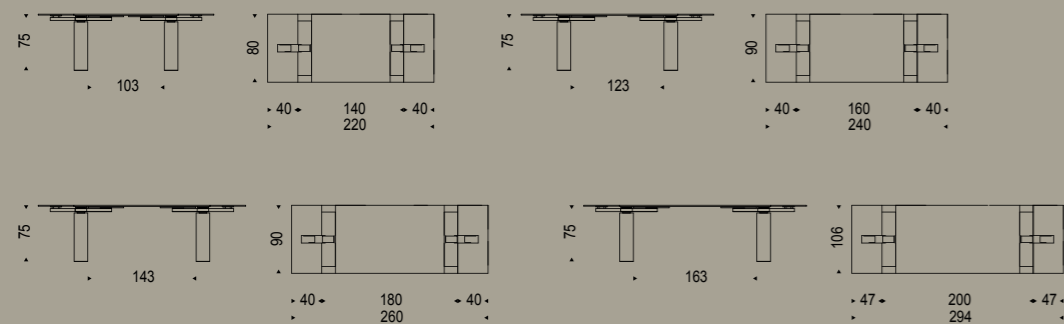



table AZIMUT - chairs MAGDA B - lamps KIDAL - mirror PHOTO - sideboard PRISMA

DAYTONA**Design Studio Kronos**

Tavolo allungabile con gambe in acciaio inox o noce Canaletto. Piano e prolunghe in cristallo temperato trasparente o extrachiaro trasparente (piano 15mm, prolunghe 12mm). Meccanismo in acciaio inox.

Extendible table with legs in stainless steel or Canaletto walnut. Top and extensions in tempered clear glass or extra clear glass (top 15mm, extensions 12mm). Stainless steel mechanism.

Table à rallonges. Piètement en acier inox ou noyer Canaletto. Plateau et allonges en verre trempé transparent ou transparent extra-clair (plateau 15mm, allonges 12mm). Mécanisme en acier inox.

Mesa extensible con patas en acero inox o nogal Canaletto, sobre y extensiones en cristal templado transparente o extraclaro (sobre 15mm, extensiones 12mm). Mecanismo en acero inox.

Ausziehbarer Esstisch mit Beine aus Edelstahl oder Nußbaum Canaletto. Platte und Verlängerungen aus transparentem oder extra hell transparentem Sicherheitsglas (Platte 15mm, Verlängerungen 12mm). Mechanismus aus Edelstahl.

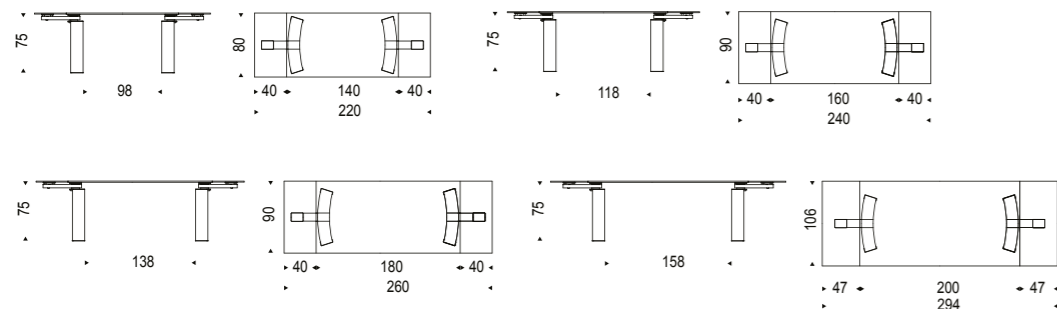



DAYTONA ALMOND

Design Studio Kiranov

Tavolo allungabile con gambe in acciaio inox o noce Canaletto. Piano e prolunghe in cristallo temperato trasparente o extrachiaro trasparente (piano 15mm, prolunghe 12mm). Meccanismo in acciaio inox.

Extendible table with legs in stainless steel or Canaletto walnut. Top and extensions in tempered clear glass or extra clear glass (top 15mm, extensions 12mm). Stainless steel mechanism.

Table à rallonges. Piètement en acier inox ou noyer Canaletto. Plateau et allonges en verre trempé transparent ou transparent extra-clair (plateau 15mm, allonges 12mm). Mécanisme en acier inox.

Mesa extensible con patas en acero inox o nogal Canaletto, sobre y extensiones en cristal templado transparente o extraclaro (sobre 15mm, extensiones 12mm). Mecanismo en acero inox.

Ausziehbarer Esstisch mit Beine aus Edelstahl oder Nußbaum Canaletto. Platte und Verlängerungen aus transparentem oder extra hell transparentem Sicherheitsglas (Platte 15mm, Verlängerungen 12mm). Mechanismus aus Edelstahl.

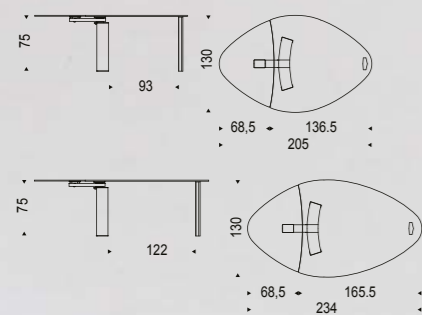



BRERA**Design Andrea Gulisano**

Tavolo allungabile con gambe in acciaio inox, acciaio verniciato bianco lucido o graphite opaco. Piano in appoggio in cristallo 10mm temperato extrachiaro verniciato bianco o graphite. Prolunga in cristallo 10mm temperato in tinta col piano.

Extendible table with base in stainless steel, varnished polished white or matt graphite steel. Top in 10mm extra clear white varnished tempered glass or extra clear graphite varnished glass. The top is laid on the base. Extension in 10mm tempered glass in the same colour of the top.

Table à rallonges, piètement en acier inox, acier verni blanc brillant ou graphite mat. Plateau d'appui en verre 10mm trempé extra-clair verni blanc ou extra-clair verni graphite. Rallonge en verre 10mm trempé même finissage du plateau.

Mesa extensible con patas en acero inox, acero barnizado blanco brillo o graphite mate. Sobre en apoyo en cristal 10mm templado extraclaro pintado blanco o extraclaro pintado graphite.

Ausziehbarer Esstisch, Beine Edelstahl, Edelstahl lackiert weiß oder matt graphite. Gelegte Platte gehärtetem Glas 10mm lackiert weiß oder graphite. Verlängerung 10mm Glas, Ausführung wie Hauptplatte.

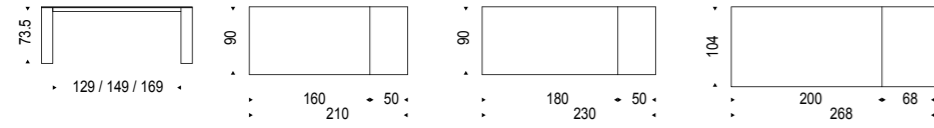



MONDAY

Design Pierluigi Stello

Tavolo allungabile con telaio e gambe in acciaio verniciato bianco o graphite opaco. Top and extensions in polished white postformato bianco lucido o piano in cristallo temperato 10mm extrachiaro verniciato bianco con prolunghe in laminato o piano in cristallo extrachiaro verniciato graphite con prolunghe in MDF formicato in tinta.

Extendible table with frame and base in white or graphite varnished steel. Top and extensions in polished white post-formed laminated finish or in tempered extra clear white varnished 10mm glass with extensions in laminated finish, or in extra clear graphite varnished glass with matching formica MDF extensions.

Table à allonges avec pieds et structure en acier verni blanc ou graphite opaque. Plateau et allonges en laminé postformé blanc brillant ou plateau en verre 10mm tempré extra-clair verni blanc avec allonges en laminé, ou plateau en verre extra-clair verni graphite et allonges en MDF de formica en correspondance.

Mesa extensible con estructura y patas en acero barnizado blanco o graphite mate. Sobre y extensiones en laminado postformado blanco brillo o en cristal templado 10mm extraclaro barnizado blanco con extensiones en laminado, o sobre en cristal extraclaro barnizado graphite con extensiones en MDF de formica en juego.

Ausziehbarer Tisch mit Gestell und FüÙe aus Stahl weiss oder graphite matt lackiert. Platte und Verlängerungen aus weiß glänzendem Postforming Laminat oder aus gehärtetem 10mm Optiwhite-Glas weiß lackiert und Verlängerungen aus Laminat, oder Platte aus graphite lackiert und Verlängerungen aus Formica MDF in Farbton.





ELVIS WOOD DRIVE

Design **Alberto Danese**

Tavolo allungabile con base in acciaio inox o verniciato goffrato bianco o graphite. Piano e prolunghe in acciaio inox o verniciato goffrato bianco o graphite. Piano e prolunghe in legno noce Canaletto o rovere bruciato.

Extendible table with base in white or graphite embossed lacquered steel or in stainless steel. Top and extensions in Canaletto walnut or burned oak.

Table à rallonges avec base en acier gaufré verni blanc, graphite ou inox. Plateau et rallonges en noyer Canaletto ou rouvre brûlé.

Mesa extensible con base en acero inox o barnizado gofrado blanco o graphite. Sobre y extensiones en madera nogal Canaletto o roble ahumado.

Ausziehbarer Esstisch mit Basis aus Edelstahl oder Stahl lackiert weiß oder Graphit gaufriert. Platte und Verlängerungen in Nussbaum Canaletto oder "verbrannte Eiche".

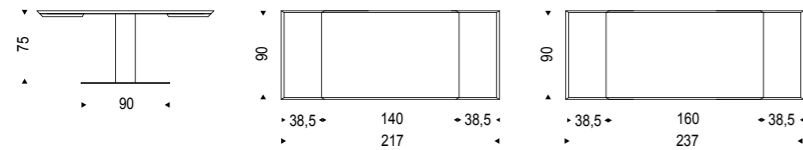

ELVIS WOOD pag. 158

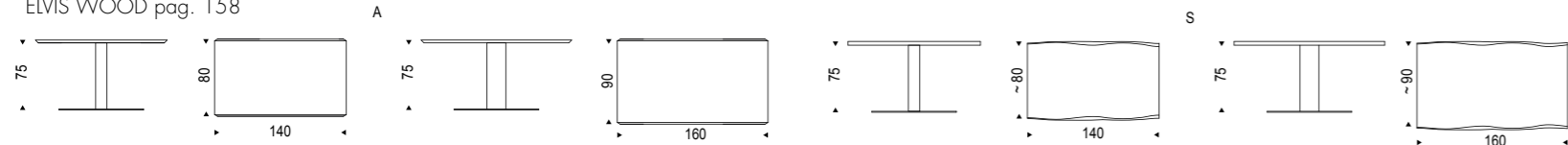



2
 LAND AND
 LANDSCAPE
 THE COMMON
 ENCOUNTER

PEDRO DRIVE**Design Pierluigi Stella**

Tavolo con base in acciaio verniciato bianco o graphite opaco, con o senza profili in acciaio inox. Piano e prolunghe in postformato laminato bianco opaco, laminato porfido grigio, laminato ossido grigio, laminato olmo bianco.

Table with base in matt white or graphite painted steel with or without profile in stainless steel. Top in matt white postformed, grey porphyry, grey oxide, white elm laminated wood.

Table avec base en acier laqué blanc ou graphite mat, avec ou sans profil en acier inox. Plateau postformés en laminé blanc mat, laminé porfido gris, laminé orme blanc.

Mesa con base en acero barnizado blanco o graphite opaco, con o sin perfil en acero inox. Sobre en postformado laminado blanco opaco, laminado pórfido gris, laminado óxido gris, laminado olmo blanco.

Eßtisch mit Basis aus Edelstahl lackiert in matt weiß oder matt graphite, mit oder ohne Profilen aus Edelstahl. Platte aus postforming matt weiß laminat, laminat grau Porphy, laminat grau Oxid oder laminat Ulme weiß.

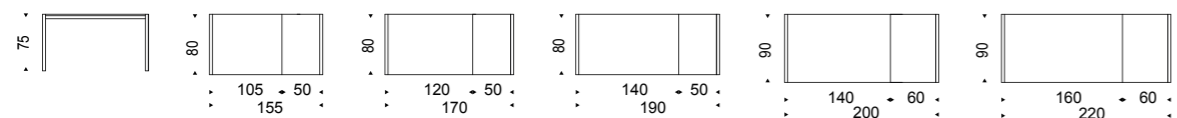

PEDRO pag. 154

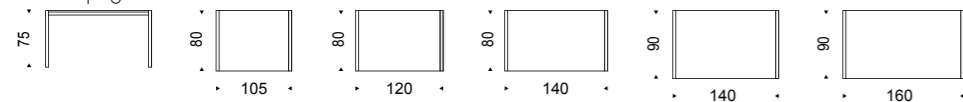



NEMO DRIVE**Design Paolo Cattelan**

Tavolo allargabile con base in acciaio verniciato gofrato bianco o graphite. Piano e prolunghe in laminato bianco climb, ossido grigio, noce, grigio Londra Fenix o castoro Ottawa Fenix. Inclusa borsa porta prolunghe.

Extendible table with base in white or graphite embossed lacquered steel. Top and extensions in white climb, grey oxide, walnut, grey London Fenix or beaver Ottawa Fenix laminated wood. Bag for extension included.

Table à rallonges avec base en acier laqué gaufré blanc ou graphite. Plateau et rallonges en laminé blanc climb, oxyde gris, noyer, gris Londres Fenix ou castor Ottawa Fenix. Porte rallonges inclus.

Mesa extensible con base en acero barnizado gofrado blanco o graphite. Sobre y extensiones en laminado blanco climb, óxido gris, nogal, gris Londres Fenix o castor Ottawa Fenix. Bolsa para extensiones incluida.

Ausziehbarer Esstisch mit Basis in Stahl lackiert weiß oder graphite gaufriert. Platte und Verlängerungen aus Laminat weiß Climb, grau Oxid, Nussbaum, London grau Fenix Laminat oder Biber Ottawa Fenix Laminat. Tasche für Verlängerungen ist enthalten.

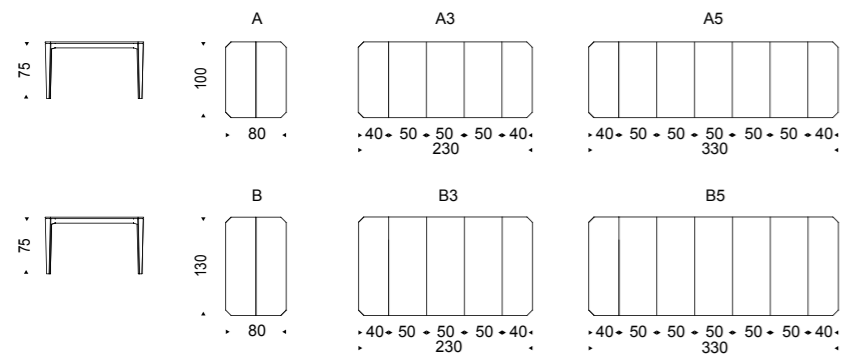



table NEMO DRIVE - chairs SOFIA - lamps GALAXY - floor lamp FLAG - sideboard DAKOTA - rug HALIBUT

ELVIS WINGS**Design Alberto Danese**

Tavolo con base in acciaio inox. Piano in cristallo trasparente 15mm. Opzionale: prolunghe in acciaio inox solo per piani in cristallo.

Table with base in stainless steel. Top in 15mm clear glass. Optional: stainless steel extensions only for glass top.

Table avec base en inox brillant. Plateau en verre clair 15mm. Optionnels: rallonges en acier seulement pour le plateau en verre.

Mesa con base en acero inox. Sobre en cristal transparente 15mm. Opcional: extensiones en acero solo par el sobre en cristal.

Esstisch mit Basis aus Edelstahl. Platte aus Klarglas transparent 15mm. Optional: edelstahl Verlängerungen nur für Glasplatte.

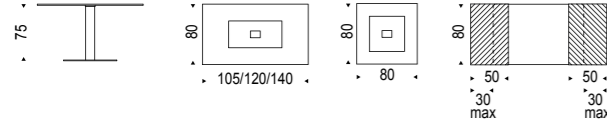

table ELVIS WINGS - chairs KAORI - lamps CALIMERO, HUBLOT - sideboards KAYAK 2

ELVIS DRIVE**Design Alberto Danese**

Tavolo allungabile con base in acciaio inox anti-impronta e colonna in acciaio inox. Piano in cristallo trasparente temperato 15mm e prolunghe in metacrilato trasparente.

Extendible table with stainless steel anti-marks base and stainless steel column. Top in 15mm clear tempered glass with transparent methacrylate extensions.

Table à rallonges avec pieds en acier inox anti-empainte et colonne en acier inox. Top en verre transparent trempé 15mm et rallonges en méthacrylate transparent.

Mesa extensible con base en acero inox antihuella y columna en acero inox. Sobre en cristal transparente templado 15mm y extensiones en metacrilato transparente.

Ausziehbarer Esstisch mit Basis aus "gegen Abdrücke" Edelstahl und Säule aus Edelstahl. Platte aus Sicherheitsglas transparent 15mm und Verlängerungen aus transparentem Methacrylat.

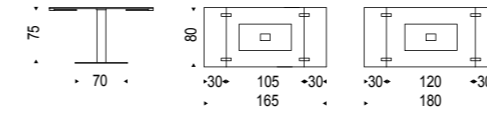

CONSOLE_CONSOLES



DIAPASON CONSOLLE 278



ELVIS CONSOLLE 279



HORIZON 280



MONACO CONSOLLE 268



MONACO CONSOLLE 270



MUSEUM CONSOLLE 276



PORTOFINO 274



RAPA NUI 272

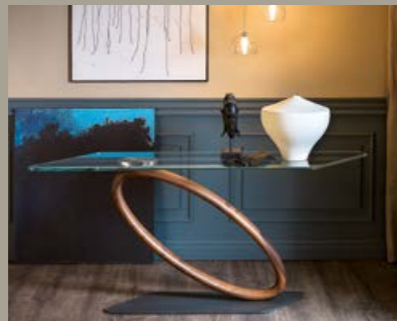

TOUR 264



VALENTINO CONSOLLE 262



VALENTINOX CONSOLLE 260



WESTIN 255



WESTIN WOOD 254



WISH BOARD 282



consolle WESTIN WOOD - lamp MIDDAY - mirror STRIPES

WESTIN**Design Giorgio Cattelan**

Consolle con base in acciaio verniciato gofrato bianco, graphite o mix. Piano in cristallo 12mm trasparente, trasparente extrachiaro o in legno noce Canaletto, rovere bruciato o rovere naturale con bordo irregolare in massello. Fissaggio a parete necessario.

Console with base in white, graphite or mix embossed lacquered steel. 12mm top in clear, extra clear glass or solid Canaletto walnut, burned oak or natural oak with irregular edges. Wall anchorage is required.

Console avec base en acier gaufré, verni blanc, graphite ou mix. Top en verre transparent, transparent extra-clair 12mm ou en bois de noyer Canaletto, roivre brûlé ou roivre naturel avec bord irrégulier en massif. Fixation au mur est nécessaire.

Consola con base en acero barnizado gofrado blanco, graphite o mix. Sobre en cristal 12mm transparente, transparente extraclaro o de madera nogal Canaletto, roble ahumado o roble natural con bordes irregulares en macizo. Ajuste a la pared es necesario.

Konsole mit Basis in Stahl lackiert weiss oder graphite gaufriert oder mix. Platte in transparentem oder extra hell Glas in 12mm oder aus Holz Nussbaum Canaletto, "verbrannte Eiche" oder Natur Eiche mit massiven Kanten. Wandbefestigung ist notwendig.

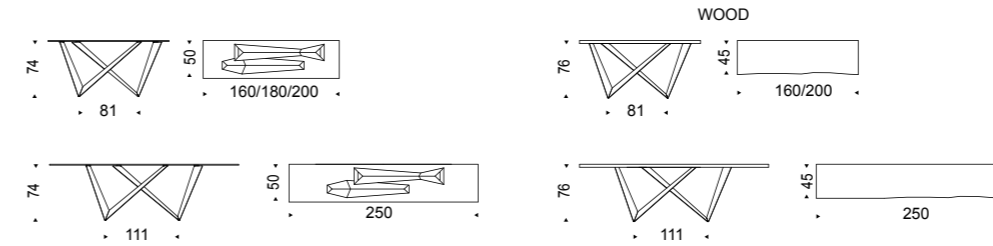





console WESTIN - lamp ZEPPELIN - mirror EMERALD - bookcase JOKER - pouff PINKO

VALENTINOX CONSOLLE

Design Emanuele Zenare

Consolle con base in acciaio inox lucido. Cilindro in Travertino, marmo nero Marquina o bianco Carrara. Piano in cristallo trasparente o fumé 12mm. Piano in appoggio.

Console with polished stainless steel base and cylinder in Travertine, Black Marquina or white Carrara marble. Top in 12mm clear or fumé glass, laid on the base.

Consolle avec base en acier inox brillant et cylindre en Travertin, marbre noir Marquina ou blanc Carrara. Plateau en verre clair ou fumé 12mm en appui.

Consola con base en acero inox brillo. Cilindro en mármol Travertino, negro Marquina o blanco Carrara. Sobre en cristal transparente o fumé 12mm. Sobre en apoyo.

Konsole mit Basis aus glänzendem Edelstahl. Zylinder aus Travertin, schwarzem Marquina oder weißem Carrara Marmor. Platte aus Klar- oder rauchigem Glas 12mm auf dem Basis gelegt.

VALENTINOX CONSOLLE

261



VALENTINO CONSOLE

Design Emanuele Zenere

Console con base in noce Canaletto o rovere bruciato e cilindro in Travertino, marmo nero Marquina o bianco Carrara. Piano in cristallo trasparente o fumè 12mm. Piano in appoggio.

Console in Canaletto walnut or burned oak and cylinder in Travertine, black Marquina or white Carrara marble. Top in 12mm clear or fumè glass, laid on the base.

Console avec base en noyer Canaletto ou rouvre brûlé et cylindre en Travertin, marbre noir Marquina ou blanc Carrara. Plateau en verre clair ou fumè 12mm en appui.

Consola con base en nogal Canaletto o roble ahumado. Cilindro en mármol Travertino, negro Marquina o blanco Carrara. Sobre en cristal transparente o fumè 12mm. Sobre en apoyo.

Konsole mit Fuß aus Nussbaum Canaletto oder "verbrannte Eiche". Zylinder aus Travertin, schwarzem Marquina, weißem Carrara Marmor. Platte aus Klar- oder rauchigem Glas 12mm auf dem Basis gelegt.



TOUR CONSOLE

Design **Giorgio Cattelan**

Console con base in acciaio verniciato gofrato graphite, gamba in noce Canaletto. Piano in cristallo trasparente, trasparente extrachiaro o noce Canaletto. Portata massima 10 kg distribuiti. Fissaggio a parete necessario.

Console with base in graphite embossed lacquered steel and leg in Canaletto walnut. Top in clear glass, extra clear glass or Canaletto walnut. Max capacity 10 kg spread load. Wall anchorage is required.

Console avec base en acier laqué gaufré graphite mat et pied en noyer Canaletto. Plateau un verre clair, extra-clair ou noyer Canaletto. Poids maximum admis 10 kg répartis. La fixation au mur est nécessaire.

Consola con base en acero barnizado gofrado graphite, pata en nogal Canaletto. Sobre en cristal transparente, transparente extrachiaro o nogal Canaletto. Capacidad máxima 10 kg distribuidos. Ajuste a la pared es necesario.

Konsole mit Basis in Stahl lackiert graphite gaufriert und Bein aus Nussbaum Canaletto. Platte in transparentem oder extra hell transparentem Glas oder Nussbaum Canaletto. Maximale Belastbarkeit 10 kg (verteilt). Wandbefestigung ist notwendig.

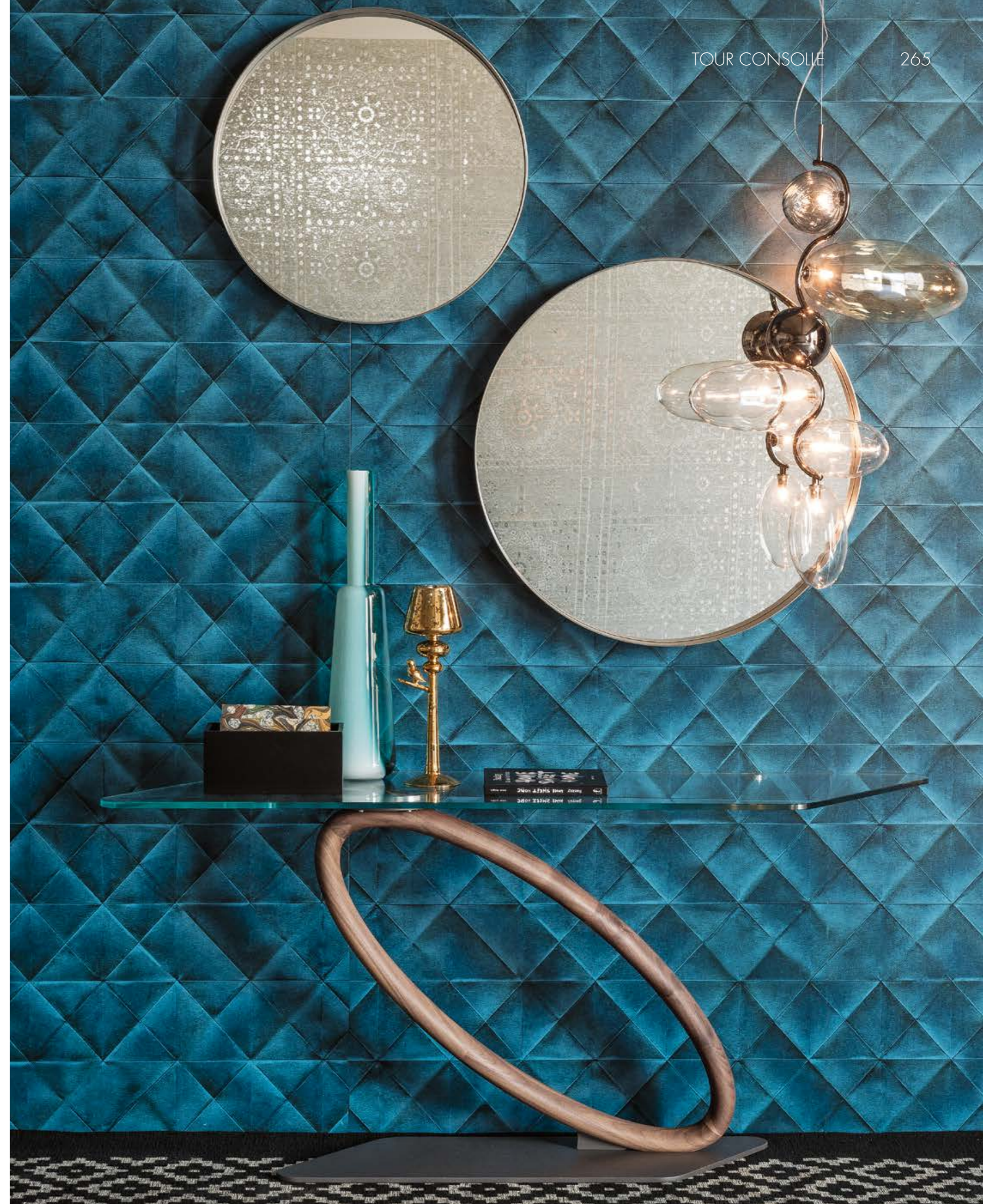
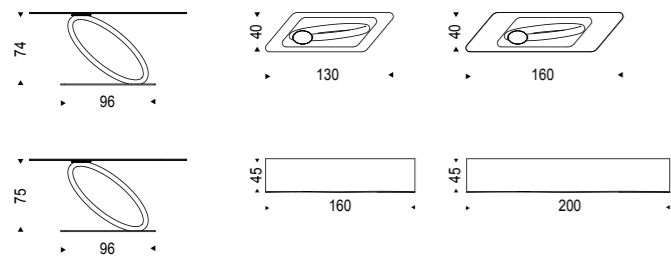



console TOUR - lamp BABAN - mirror DIAMOND - chair MUSA B - rug MAPOON

MONACO CONSOLLE

Design **Giorgio Cattelan**

Consolle con base in noce Canaletto, rovere bruciato, marmo bianco Carrara o inox. Piedi in acciaio lucido. Piano con piastre in cristallo trasparente 15mm. Piccole irregolarità di riflessione sulla base in inox sono dovute alla lavorazione manuale.

Console with base in Canaletto walnut, burned oak, white Carrara marble or stainless steel. Stainless steel feet. Top with plates in 15mm clear glass. Small reflection's irregularities on the stainless steel base are due to manual processing.

Consolle avec base en noyer Canaletto, rouvre brûlé, marbre blanc Carrara ou en inox. Pieds en acier inox. Plateau avec plates en verre clair 15mm. Les petites irrégularités de réflexion sur la base en acier inox sont dues à une fabrication manuelle.

Consola con base en nogal Canaletto, roble ahumado, mármol blanco Carrara o en acero inox. Patas en acero inox brillo. Sobre con pletinas en cristal transparente 15mm. Pequeñas irregularidades de reflexión en la base en acero inox están causadas por la producción manual.

Konsole mit Basis in Nussbaum Canaletto, "verbrannte Eiche", weißem Carrara Marmor oder aus Edelstahl. Füße aus Edelstahl glänzend. Platte mit metalplättchen aus Klarglas 15mm. Kleine Unregelmäßigkeiten der Reflexion auf der Edelstahl Basis sind nicht zu vermeiden, da das Teil per Hand hergestellt wird.

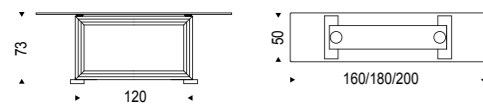



consolle MONACO - lamp BABAN - mirror MOMENT - rug DELHI

RAPA NUI

Design Oriano Favaretto

Consolle con gambe in cemento verniciato in pasta nei colori bianco o grigio. Piano in cristallo 12mm trasparente, trasparente extrachiario o in legno noce Canaletto, rovere bruciato o rovere naturale con bordo irregolare in massello. Fissaggio a parete necessario.

Console with legs in white or grey colored cement. 12mm top in clear, extra clear glass or solid Canaletto walnut, burned oak or natural oak with irregular edges. Wall anchorage is required.

Console avec base en ciment coloré blanc ou gris. Top en verre claire, extra-clair 12mm ou en bois noyer Canaletto, rovere brûlé ou rovere naturel avec bord irrégulier en massif. La fixation au mur est nécessaire.

Consola con base en cemento pintado blanco o gris. Sobre en cristal transparente 12mm, transparente extraclaro o en madera nogal Canaletto, roble ahumado o roble natural con bordes irregulares macizos. Ajuste a la pared es necesario.

Konsole mit Basis aus Zementleim in den Farben weiß oder grau. Platte in transparentem oder extra hell transparentem Glas in 12mm oder in Holz Nussbaum Canaletto, "verbrannte Eiche" oder Natur Eiche mit massiven Kanten. Wandbefestigung ist notwendig.

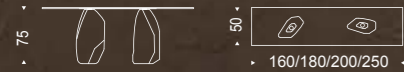

PORTOFINO
Design Paolo Cattelan

Consolle o panca rivestita in
cristallo bisellato specchiato,
specchiato fumé, extrachiaro
verniciato bianco.

Console or bench covered in
bevelled mirrored glass, smoke-
grey mirrored glass, extra clear
white painted glass.

Consolle ou banc en verre
biseauté miroité ou miroité
fumé ou en verre extra-clair
verni blanc.

Consola o banco revestida en
cristal biselado espejo, espejo
fumé o extraclaro barnizado
blanco.

Konsole oder Bank verkleidet
mit abgekantetem Glas
verspiegelt, rauchig-
verspiegelt, extra hell weiß
Glas lackiert.

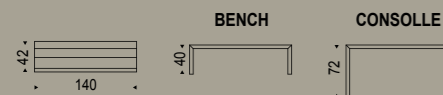

MUSEUM CONSOLLE

Design

G. Cattelan & A. Lucatello

Consolle con base in acciaio verniciato trasparente, ramato, goffrato bianco o graphite. Cilindro in marmo bianco Carrara o Travertino naturale. Piano in cristallo trasparente 15mm.

Consolle with base in transparent varnished steel, copper, embossed white or graphite lacquered steel. Cylinder in natural Travertine or white Carrara marble. 15mm clear glass top.

Consolle avec base en acier laqué transparent, cuivre, gaufré blanc ou graphite et cylindre en marbre Travertin ou blanc Carrara. Plateau en verre clair 15 mm.

Consola con base en acero barnizado transparente, cobre, gofrado blanco o graphite. Cilindro en mármol Travertino o blanco Carrara. Sobre en cristal 15mm transparente.

Konsole mit Basis aus Metall lackiert transparent, ver Kupfert oder weiß oder graphite gaufriert. Zylinder aus Travertin oder weißem Carrara Marmor. Platte 15mm in Glas transparent.

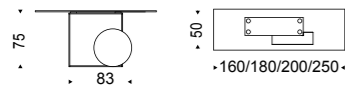

consolle MUSEUM - lamp BOLERO - chair ARIA - rug HALIBUT



consolle MUSEUM - lamps APOLLO - mirror RING

DIAPASON

Design Studio Diapason
 Consolle con base in Travertino o bianco Carrara e piano in cristallo trasparente 12mm. Piano in appoggio.

Console with Travertine or white Carrara marble base. Clear glass 12mm. The top is laid on the base.

Consolle avec base en Travertin ou blanc Carrara. Plateau en verre clair 12mm. Plateau en appui.

Consola con base en mármol Travertino o blanco Carrara. Sobre en cristal transparente 12mm. Sobre en apoyo.

Konsole mit Fuß aus Travertin oder weiß Carrara Marmor. Klarglasplatte 12mm auf dem Basis gelegt.

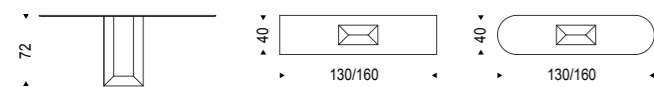

consolle DIAPASON - lamp MIDDAY - mirror MOMENT

ELVIS CONSOLLE

Design Alberto Danese
 Consolle con base in acciaio inox anti-impronta e colonna in acciaio inox. Piano in cristallo trasparente.

Console with stainless steel anti-marks base and stainless steel column. Fixed top in 15mm clear glass or extendible version in polished white laminated.

Consolle avec base en acier inox anti empreinte et colonne en inox. Plateau en verre transparent.

Consola con base en acero inox anti huellas y columna en acero inoxidable. Sobre fijo en cristal transparente.

Konsole mit Unterbau aus Anti finger Edelstahl und Standrohr aus Edelstahl. Platte aus Klarglas transparent.

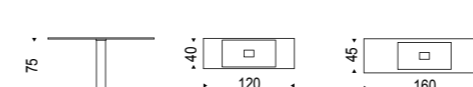

ELVIS CONSOLLE DRIVE pag. 300

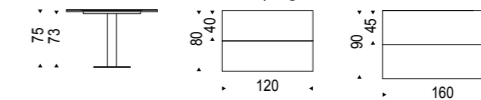

consolle ELVIS CONSOLLE - chair SAMANTHA - mirror WISH

HORIZON

Design **Alessio Bassan**

Madia/consolle/porta TV a 2 cassetti in noce Canaletto o rovere bruciato. Top in cristallo extrachiaro acidato verniciato graphite. Base in acciaio verniciato gofrato graphite. Versione A1 e A2 con ripiano inferiore in noce Canaletto o rovere bruciato.

Sideboard/console/ TV stand with 2 drawers in Canaletto walnut or burned oak. Top in graphite painted frosted extra clear glass. Graphite embossed laquered steel base. A1 and A2 versions with lower shelf in Canaletto walnut or burned oak.

Bahut/consolle avec 2 tiroirs en noyer Canaletto ou rovre broulé. Plateau en verre extra-clair dèpoli laqué graphite. Pieds en acier laqué gaufré graphite mat. Version A1 et A2 avec étagère inférieur en noyer Canaletto ou rovre brulé.

Aparador/consola con 2 cajones en nogal Canaletto o roble ahumado. Sobre en cristal extraclaro translúcido barnizado graphite. Patas en acero barnizado gofrado graphite. Versiones A1 y A2 con estante bajo en nogal Canaletto o roble ahumado.

Anrichte mit 2 Schubladen aus Nussbaum Canaletto oder "verbrannte Eiche". Platte aus Glas extra hell geätzt graphite lackiert. Füße aus Stahl lackiert graphite gaufriert. Version A1 und A2 mit niedrigem Regal aus Nussbaum Canaletto oder "verbrannte Eiche".

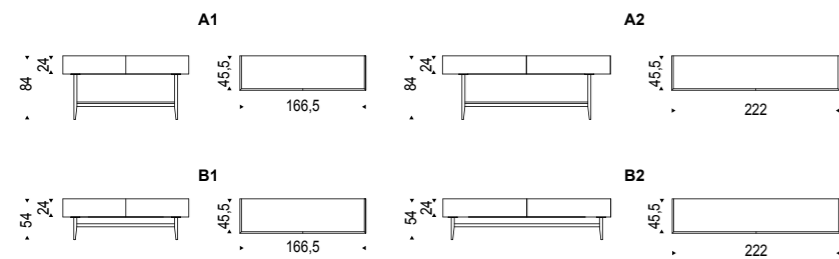

WISH BOARD**Design Paolo Cattelan**

Specchio da parete in cristallo specchiato. Cornice in acciaio verniciato trasparente, gofrato graphite o nero. Mensola in noce Canaletto o rovere Heritage.

Wall mirror in mirrored glass. Frame in transparent varnished steel, graphite or black embossed lacquered steel. Shelf in Canaletto walnut or Heritage oak.

Miroir mural avec cadre en acier laqué transparent, gaufré graphite ou noir. Étagère en noyer Canaletto ou rovere Heritage.

Espejo de pared en cristal reflejado. Marco en acero barnizado transparente, gofrado graphite o negro. Repisa en nogal Canaletto o roble Heritage.

Wandspiegel in Glas verspiegelt. Rahmen in Metall lackiert transparent, graphite oder schwarz gaufriert. Boden in Nussbaum Canaletto oder Eiche Heritage.

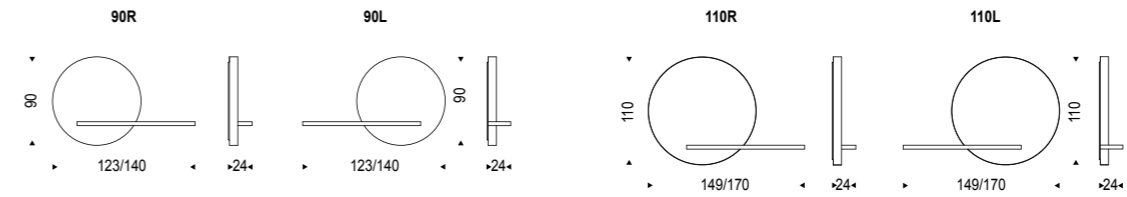

console WISH BOARD - coat hanger VALDO - rug HALIBUT

CONSOLLE ALLUNGABILI_EXTENDABLE CONSOLES



CONVIVIUM



287



ELVIS CONSOLLE DRIVE



300



NEMO CONSOLLE



296



PARTY



292

CONVIVIUM

Design **Giorgio Cattelan**

Consolle allungabile con base in acciaio verniciato gofrato bianco, graphite o inox satinato. Piano e prolunghe in laminato bianco climb, ossido grigio, noce, grigio Londra Fenix o beaver Ottawa Fenix. Inclusa borsa porta prolunghe.

Extendible console with base in white or graphite embossed lacquered steel or in satin stainless steel. Top and extensions in white climb, grey oxide, walnut, grey London Fenix or beaver Ottawa Fenix laminated wood. Bag for extensions included.

Console à rallonges avec base en acier laqué gaufré blanc, graphite ou inox satiné. Plateau et rallonges en laminé blanc climb, oxyde gris, noyer, gris Londres Fenix ou castor Ottawa Fenix. Porte rallonges compris.

Consola extensible con base en acero barnizado gofrado blanco, graphite o acero inox satinado. Sobre y extensiones en laminado blanco climb, óxido gris, nogal, gris Londres Fenix o castor Ottawa Fenix. Bolsa para extensiones incluida.

Konsole mit Verlängerungen, Basis in Stahl lackiert weiß oder graphite gaufriert oder in Edelstahl gebürstet. Platte und Verlängerungen aus Laminat in den Farben: weiß Climb, grau Oxid, Nussbaum, London grau Fenix oder Biber Ottawa Fenix. Tasche für Verlängerungen ist enthalten.

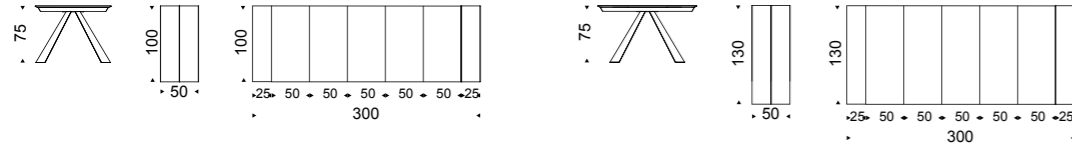

consolle extensible CONVIVIUM - chairs ISABEL, MAGDA B, BEVERLY, PATRICIA, BRIGITTA, PIUMA B - pouf BOB - lamp DREAM - bookcases SWING







console extensible CONVIVIUM - chair MAGDA B - lamp VENEZIA - rug JAIPUR

PARTY**Design Giorgio Cattelan**

Consolle allungabile con base in acciaio verniciato gofrato bianco o graphite. Piano e prolunghe in laminato bianco climb, ossido grigio, noce, grigio Londra Fenix o castoro Ottawa Fenix. Inclusa borsa porta prolunghe.

Extensible console with base in white or graphite embossed lacquered steel. Top and extensions in white climb, grey oxide, walnut, grey London climb, or beaver Ottawa Fenix laminated wood. Bag for extension included.

Console à rallonges avec base en acier laqué gaufré blanc ou graphite. Plateau et rallonges en laminé blanc climb, oxyde gris, noyer, gris Londres Fenix ou castor Ottawa Fenix. Porte rallonges inclus.

Consola extensible con base en acero barnizado gofrado blanco o graphite. Sobre y extensiones en laminado blanco climb, óxido gris, nogal, gris Londres Fenix o castor Ottawa Fenix. Bolsa para extensiones incluida.

Konsole mit Verlängerungen, Basis in Stahl lackiert weiß oder graphite gaufriert. Platte und Verlängerungen aus Laminat weiß Climb, grau Oxid, Nussbaum, London grau Fenix Laminat oder Biber Ottawa Fenix Laminat. Tasche für Verlängerungen ist enthalten.

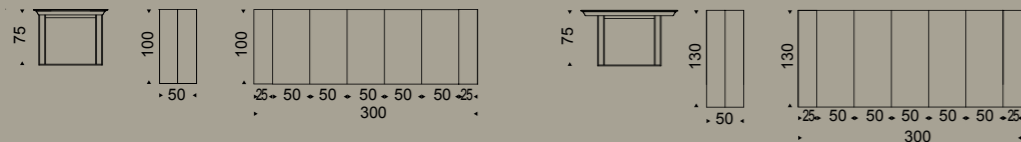



console extensible PARTY - chairs AMY - lamps MEDUSA

NEMO CONSOLLE

Design Paolo Cattelan

Consolle allungabile con base in acciaio verniciato gofrato bianco o graphite. Piano e prolunghe in laminato bianco climb, ossido grigio, noce, grigio Londra Fenix o castoro Ottawa Fenix. Inclusa borsa porta prolunghe.

Extendible console with base in white or graphite embossed lacquered steel. Top and extensions in white climb, grey oxide, walnut, grey London climb, ossido grigio, noce, grigio Londra Fenix or beaver Ottawa Fenix laminated wood. Bag for extension included.

Console à rallonges avec base en acier laqué gaufré blanc ou graphite. Plateau et rallonges en laminé blanc climb, oxyde gris, noyer, gris Londres Fenix ou castor Ottawa Fenix. Porte rallonges inclus.

Consola extensible con base en acero barnizado gofrado blanco o graphite. Sobre y extensiones en laminado blanco climb, óxido gris, nogal, gris Londres Fenix o castor Ottawa Fenix. Bolsa para extensiones incluida.

Konsole mit Verlängerungen, Basis in Stahl lackiert weiß oder graphite gaufriert. Platte und Verlängerungen aus Laminat weiß Climb, grau Oxid, Nussbaum, London grau Fenix Laminat oder Biber Ottawa Fenix Laminat. Tasche für Verlängerungen ist enthalten.

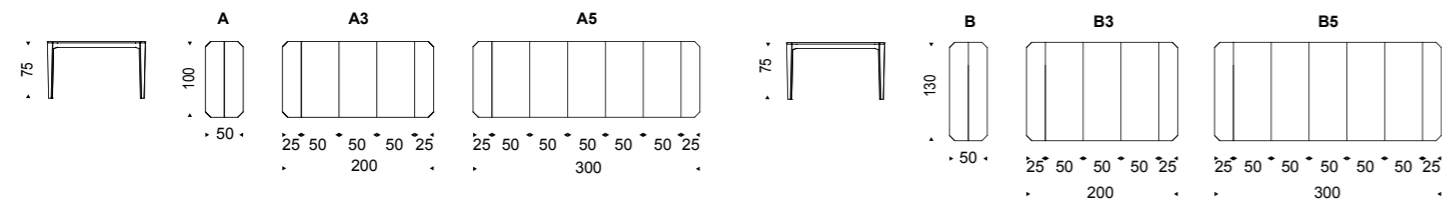



ELVIS CONSOLLE

Design **Alberto Danese**

Tavolo/consolle con base in acciaio inox anti-impronta e colonna in acciaio inox. Piano in cristallo trasparente o piano e prolunga in laminato bianco.

Table/console with stainless steel anti-marks base and stainless steel column. Fixed top in 15mm clear glass or extendible version in polished white laminated.

Table/console avec base en acier inox anti empreinte et colonne en inox. Plateau en verre transparent ou laminé brillant blanc.

Mesa/Consola con base en acero inox anti huellas y columna en acero inoxidable. Sobre fijo en cristal transparente o sobre extensible en laminado blanco brillo.

Tisch/Konsole mit Unterbau aus Anti finger Edelstahl und Standrohr aus Edelstahl. Platte aus Klarglas transparent oder Laminat weiß.

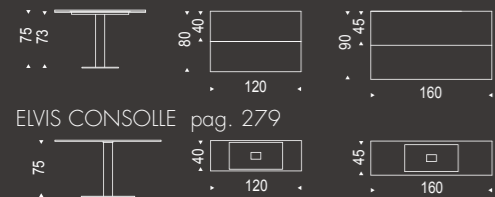

SCRIVANIE_DESKS



BATIK

320



DAVINCI

328



DYNO DESK

324



ISLAND

330



LAP

327



NASDAQ

304



QWERTY

316



STORM

322



VEGA

310



VEGA

312

NASDAQ**Design Paolo Cattelan**

Scrivania con cassetiera in legno noce Canaletto o rovere Heritage. Gamba in acciaio verniciato groffrato graphite.

Desk with drawers in Canaletto walnut or Heritage oak. Leg in graphite embossed lacquered steel.

Bureau avec tiroirs en noyer Canaletto ou rouvre Heritage. Pied en acier gaufré verni graphite.

Escritorio con cajones en madera nogal Canaletto o roble Heritage. Pata en acero barnizado gofrado graphite.

Schreibtisch mit Schubladen aus Nussbaum Canaletto oder Eiche Heritage. Bein aus Stahl lackiert graphit gaufriert.

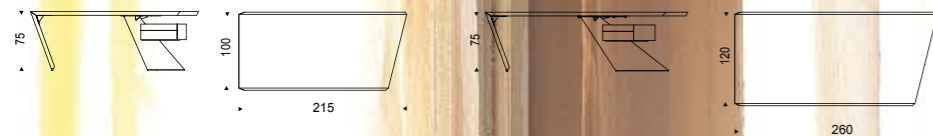



desk NASDAQ heritage oak





VEGA**Design Giorgio Cattelan**

Scrivania in acciaio inox lucido o rivestita in noce Canaletto o rovere bruciato con interno verniciato graphite opaco. Accessori disponibili: dattilo nella stessa finitura della scrivania (deve essere sorretto da cassettera), cassettera su ruote a due cassette con struttura verniciata argento o graphite e frontale in cuoio come da campionario, pad in cuoio come da campionario.

Desk in polished stainless steel or covered in Canaletto walnut or burned oak with inner sides painted in matt graphite. Optional accessories: peninsula in the same finish as the desk (to be supported by drawer-unit), two-drawer-unit on wheels with silver or graphite lacquered structure and front part of the drawers in leather as per sample card.

Bureau en acier inox brillant ou revêtu en noyer Canaletto ou rovre brûlé et intérieur verni graphite mat. Accessoires disponibles: retour dans la même finition du bureau (doit être soutenu par le meuble à tiroirs), meuble à deux tiroirs sur roulettes avec structure argent ou graphite et front des tiroirs en cuir selon échantillons.

Escritorio en acero inox brillo o revestido en nogal Canaletto o roble ahumado con interior barnizado graphite mate. Accesorios disponibles: dático en el mismo acabado del escritorio (debe ser sostenido de cajonera), cajonera sobre ruedas a dos cajones con estructura pintada plata o graphite y frontales en cuero según muestrario. Pad en cuero según muestrario.

Schreibtisch aus Edelstahl glänzend oder bezogen mit Nussbaum Canaletto oder "verbrannte Eiche", innen lackiert graphite matt. Verfügbarer Wohnzubehören: Daktylus in den Ausführung der Schreibtisch, (unbedingt auf das Schubladenelement zu befestigen), Schubladenelement auf Rollen mit zwei Schubladen, Korpus lackiert silber oder graphite und Fronten aus Kernleder laut Musterkarte, PAD aus Kernleder laut Musterkarte.

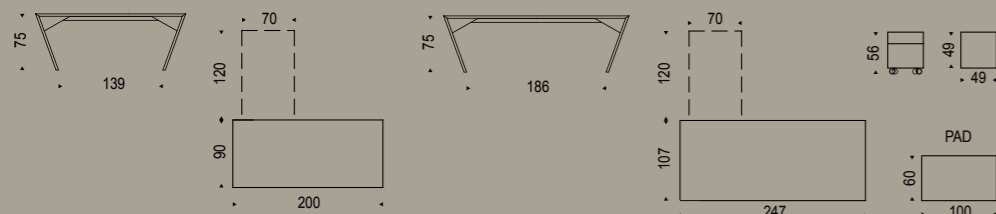





QWERTY**Design Andrea Lucatello**

Scrivitoio con struttura in acciaio verniciato bianco o graphite opaco e profili in acciaio inox. Piano in MDF laccato bianco o graphite gofrato fine. PAD in cuoio nei colori come da campionario.

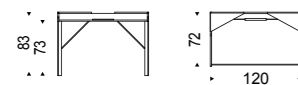

Desk with matt white or graphite painted frame and profile in stainless steel. Top in lacquered white or graphite embossed MDF. Leather pad as per sample card.

Bureau, structure en acier laqué blanc ou graphite mat et profil en acier inox. Plateau en mdf laqué blanc ou graphite gaufré. Sous-main en cuir selon échantillons.

Escritorio con estructura en acero barnizado blanco o graphite opaco y perfil en acero inox. Sobre en mdf lacado blanco o graphite gofrado fine. Pad en cuero de color según muestrario.

Schreibtisch mit Struktur aus lackiertem Stahl matt weiss oder matt graphite. Profil aus Edelstahl. Platte aus MDF weiss oder graphite lackiert gaufriert. PAD in Kernleder, Farbe laut Musterkarte.





BATIK**Design Andrea Lucatello**

Scrivania con gambe in acciaio verniciato gofrato bianco o graphite con inserti in noce Canaletto. Piano in legno verniciato gofrato bianco o graphite con contenitore in noce Canaletto.

Desk with base in white or graphite embossed lacquered steel with profiles in Canaletto walnut. Top in white or graphite embossed lacquered wood with container in Canaletto walnut.

Bureau avec structure en acier laqué gaufré blanc ou graphite et profils en noyer Canaletto. Plateau en bois laqué gaufré blanc ou graphite avec conteneur en noyer Canaletto

Escritorio con estructura en acero barnizado gofrado blanco o graphite con detalles en nogal Canaletto. Sobre en madera barnizado gofrado blanco o graphite y contenedor en nogal Canaletto.

Schreibtisch mit Struktur in Stahl lackiert weiß oder graphite gaufriert und Profil aus Nussbaum Canaletto. Platte in Holz lackiert weiß oder graphite gaufriert und Raum in Nussbaum Canaletto.



STORM**Design Andrea Lucatello**

Scrivania con struttura e piano in acciaio verniciato gofrato bianco o graphite. Leather pad in cuoio nei colori come da campionario.



Desk with frame and top in white or graphite embossed lacquered steel. Leather pad as per sample card.

Bureau avec structure et plateau en acier laqué gaufré blanc ou graphite. Sous-main en cuir selon échantillons.

Escritorio con estructura en acero barnizado gofrado blanco o graphite. Pad en cuero de color según muestrario.

Schreibtisch mit Basis und Platte aus Edelstahl lackiert weiß oder graphite gaufriert. Pad in Kernleder, Farbe laut Musterkarte.



DYNO DESK**Design Paolo Cattelan**

Piano scrittoio in legno laccato bianco opaco con sostegno laterale in acciaio verniciato bianco opaco. Da aggiungersi agli elementi Dyno a 4 o 8 cassetti.

Desk in matt white lacquered wood with lateral support in matt white lacquered steel. To be laid on the top of Dyno 4 or 8 drawers.

Bureau en bois laqué blanc matt avec support lateral en acier verni blanc matt. À appuyer sur le Dyno 4 ou 8 tiroirs.

Escritorio en madera lacada blanco mate con soporte lateral en acero barnizado blanco mate. A poner sobre de los articulos Dyno 4 o 8 cajones.

Schreiben Oberfläche in matt weiß lackiertem Holz mit Seitenhalt in matt weiß lackiertem Stahl. Zu den Elementen Dyno bis 4 oder 8 Schubladen zugesetzt.



LAP**Design Giorgio Cattelan**

Tavolino fianco divano o porta notebook regolabile in altezza. Piano in cristallo trasparente 12mm rettangolare o sagomato. Base in acciaio inox con gamba cromata o rivestita in cuoio come da campionario.

Side table or lap-top unit adjustable in height. Top in rectangular or shaped 12mm clear glass. Stainless steel base with chromed leg or covered in leather as per sample card.

Table coté/canapé ou porte-ordinateur réglable en hauteur. Top en verre transparent 12mm rectangulaire ou façonné. Base en acier inox avec pied chromé ou revêtu en cuir selon échantillons.

Mesita o porta-ordenador regulable en altura. Sobre en cristal transparente 12mm rectangular o sagomado. Base en acero inox con pata cromada o revestida en cuero según muestrario.

Couchtisch oder Computertisch mit höhenverstellbarem Gestell. Platte aus rechteckigem oder nierenförmigem Klarglas 12mm. Bodenplatte aus Edelstahl und Bein aus verchromtem Stahl oder mit Lederbezug laut Musterkarte.

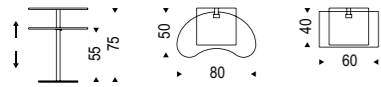

DAVINCI

Design G. Plazzogna

Scrivania in noce Canaletto e laccato opaco grey con due cassetti.

Desk in Canaletto walnut and grey lacquered wood with two drawers.

Bureau en noyer Canaletto et laqué grey avec 2 tiroirs.

Escritorio en nogal Canaletto y lacado grey con 2 cajones.

Schreibtisch in Holz grey lackiert und Nußbaumholz Canaletto mit zwei Schubladen.

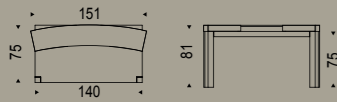

**ISLAND****Design Paolo Cattelan**

Scrivitoio con base in acciaio inox. Piano in cristallo temperato extrachiaro verniciato bianco 12mm oppure in noce Canaletto.

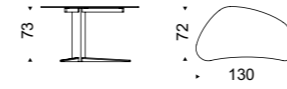

Desk with stainless steel base. Top in extra clear white painted glass (12mm tempered) or Canaletto walnut.

Bureau avec base en acier inox. Plateau en verre trempé 12mm extra-clair verni blanc ou noyer Canaletto.

Escritorio con base en acero inox. Sobre en cristal templado 12mm extraclaro barnizado blanco o nogal Canaletto.

Schreibtisch mit Basis aus Edelstahl. Platte aus Sicherheitglas 12mm extra hell weiss oder Nussbaum Canaletto.



BOOK 2 INDEX

SEDIE

Chairs_Chaises
Sillas_Stühle_Стулья

PAGE		PAGE	
46	AGATHA FLEX	37	SOFIA
50	AGATHA FLEX SLIM	41	SOFIA H
154	ALESSIA	64	TOSCA
94	AMY	65	TOSCA H
138	ANGEL	75	TYLER
83	ANNA	78	TYLER WHEELS
86	ANNA H	111	VITA
22	ARCADIA	113	VITA C
26	ARCADIA H	110	VITA H
158	ARIA	112	VITA HC
42	AURELIA	96	VITTORIA
162	BELUGA		
52	BETTY		
134	BEVERLY		
140	BRIGITTA		
100	CAROL		
120	CINDY		
92	DAISY		
160	EASY		
102	ELEONOIRE		
117	HELENA		
12	ISABEL		
14	ISABEL H		
18	ISABEL ML		
20	ISABEL ML H		
150	KAORI		
104	KATE		
142	LADY		
136	LARA		
118	LINDA		
58	LIZ		
63	LIZ H		
115	LULÙ		
30	MAGDA		
122	MARGOT		
126	MARGOT H		
129	MARGOT XL		
81	MAYA FLEX		
80	MAYA FLEX ML		
72	MULAN		
68	MUSA		
144	NINA		
146	NINA XL		
54	PATRICIA		
130	PIUMA		
90	SALLY		

SEDIE CON BRACCIOLI

Chairs with arms
Chaises avec accoudoirs
Sillas con brazos
Stühle mit Armlehne
Стулья с подлокотниками

PAGE	
82	ANNA B
87	ANNA HB
116	HELENA B
12	ISABEL B
16	ISABEL HB
19	ISABEL ML B
19	ISABEL ML HB
106	KATE B
119	LINDA B
58	LIZ B
62	LIZ HB
114	LULÙ B
32	MAGDA B
128	MARGOT XLB
73	MULAN B
70	MUSA B
132	PIUMA B
108	SAMANTHA
36	SOFIA B
41	SOFIA HB
74	TYLER B
79	TYLER WHEELS
66	TOSCA B
66	TOSCA HB

SGABELLI

Bar Stools_Tabourets_Taburetes
Barhocker_Барные Стулья

PAGE	
176	ALESSIO
182	ANNA SGABELLO
190	ARIA SGABELLO
178	BOSS
180	CINDY SGABELLO
181	CLIFF
184	COCO
186	KATE SGABELLO
183	KISS
174	MAGDA SGABELLO
187	PENNY
188	PEPE
166	TOTO
170	VITO
172	VITO X

POLTRONCINE

Easy Chairs_Petits Fauteuils
Butacas_Sessel_Кресла

PAGE	
196	ALASKA
198	CORNELIA

POUFF

Pouf_Poufs_Pouf_Puff_Пуф

PAGE	
194	BOB
192	KUBO
193	PINKO

CHAISE LONGUE

Chaise Longue_Chaises Longues
Chaise Longue_Chaise Lounge
Шезлонги

PAGE	
204	CASANOVA
208	DONOVAN
200	SYLVESTER

LIBRERIE

Bookcases_Bibliothèques
Estanterías_Bücherregale
Библиотеки

PAGE	
8	AIRPORT
50	DNA
314	DROP
44	ESTORIL
36	FIFTY
24	GIOTTO
46	JOKER
32	LOFT
28	PIQUANT
40	SWING
18	WALLY

MENSOLE

Shelves_Etagères
Estantes_Einlegeboden_Полки

PAGE	
54	CROSS
52	PENDOLA
202	WISH BOARD

MADIE

Sideboards_Crédences
Aparadores_Sideboards_Буфеты

PAGE	
118	ARABESQUE
100	CONTINENTAL
122	CHELSEA
126	DAKOTA
58	EUROPA
78	FUTURA
92	HILTON
130	HORIZON
64	KAYAK
70	LABYRINTH
104	NEBRASKA
108	OXFORD
312	PORTOS
86	PRISMA
136	SENECA
82	TORINO
74	TROPEZ
116	WEBBER

PORTA TV

Tv Units_Porte-Tv_Muebles Tv
Tv-Träger_Подставка Для ТВ

PAGE	
16	AIRPORT
144	BOXER
130	HORIZON B
140	LINK
149	PANORAMA
150	PLAY
136	SENECA
148	VISION

VETRINE

Showcases_Vitrines_Vitrinas
Vitrinen_Витрины

PAGE	
156	CHANTAL
154	CHARME
164	CONCERTO
168	MINI DECOR
161	OPEN WIND
162	SABA
166	SHIELD
160	WIND

SPECCHI

Mirrors_Miroirs_Espejos
Spiegel_Зеркала

PAGE	
184	DIAMOND
190	EGYPT
176	EMERALD
186	EXCALIBUR
210	JERSEY
208	KENYA
214	MOMENT ☺
206	PASHÀ
196	PHOTO
204	REBUS
172	REGAL
212	RING
180	STRIPES
192	TAXEDO
216	TIMES ☺
198	WISH
202	WISH BOARD

APPENDIABITI

Coats Hanger Stands_Porte Manteaux
Percheros_Kleiderständer_Вешалки

PAGE	
322	AIR
333	BAUM
330	BOTTONE
326	OSCAR
332	SIPARIO
324	VALDO
328	YANNIK

TAPPETI

Rugs_Tapis_Alfombras
Teppiche_Ковры

PAGE	
337	CHENNAI
	DARWIN
	DELHI
	HALIBUT
	JAIPUR
	MAPOON
	RUBIK

TAVOLINI

Coffee Tables_Tables Basses
Mesitas Couchtische_Журнальные Столики

PAGE	
258	ALIEN
275	ARENA
254	ATLAS
276	ATOLLO
305	AXO
236	BILLY
238	BILLY KERAMIK
240	BILLY WOOD
234	COBRA INOX
248	DADOX
256	DIELLE
288	FALCO
302	GLISS
226	GLOBE
252	HELIX
308	HUGO TAVOLINO
282	JOLLY
246	KADIR
284	KAOS
306	LAP
290	LASER
250	LEVANTE
270	LINGOTTO
292	LITRO
266	LOTHAR
296	OTTO
264	PANAMA
272	PARSIFAL
294	PAT
268	PENTA
298	PEYOTE
278	RIO
224	SAMBA
260	SCACCO
262	STONE
300	THEO
304	UP
220	VIETATO BAGNARSI
228	VIPER
244	YO-YO
280	ZEN

CARRELLI

Trolleys_Chariots_Carritos
Servierwagen_Сервировочные Столики

PAGE	
316	BRANDY
318	MOJITO
319	MOJITO WOOD
320	PROFIL BAR

COMPLEMENTI

Complements_Compléments
Complementos_Wohnzubehör
Мебельные Аксессуары

PAGE	
322	AIR
330	BOTTONE
314	DROP
334	JERRY
296	OTTO
312	PORTOS
328	YANNIK

BOOK 4 INDEX

LAMPADE A SOSPENSIONE

Pendant Lamps
Lustre_Lámparas de techo
Hängelampen_Люстры

PAGE	
48	APOLLO
80	ASTRA
72	BABAN
30	BOLERO
64	CALIMERO
20	CRISTAL
78	CUPOLONE
82	DREAM
68	ECLIPSE
16	GALAXY
40	HUBLLOT
26	KIDAL
44	LIM
46	LIM Z
54	MEDUSA
74	MIDDAY
58	OKTOPUS
62	TOPAZ
10	VENEZIA
36	ZEPPELIN

LAMPADE DA TAVOLO

Table Lamps_Lampes de table
Lámparas de sobremesa
Tischlampen_Настольные Лампы

PAGE	
98	BOLERO
134	CALIMERO
88	MAMBA
144	MEDUSA
146	MIDDAY
94	ORION
136	PLUTO
90	SEVEN
128	VENEZIA
140	ZEPPELIN

LAMPADE DA TERRA

Floor Lamps_Lampes de sol
Lámparas_Stehlampen
Напольные Лампы

PAGE	
118	ASTRA ARC
100	BOLERO
132	CALIMERO
108	COMPASS
122	FLAG
116	LITTLE FLAG
114	KARIBÙ
142	MEDUSA
120	MIDDAY ARC
96	ORION
92	SEVEN
126	SIPARIO LIGHT
110	THRILLER
130	VENEZIA
104	ZED

BOOK 5 INDEX

LETTI

Beds_Lits_Camas_Betten_Кровати

PAGE	
34	ADAM
66	ALEXANDER
86	BJORN
8	DYLAN
80	FRANKLYN
76	LOGAN
30	LUKAS
70	MARSHALL
42	MATISSE
16	NELSON
50	PATRICK
24	WILLIAM

COMÒ COMODINI

Chests Of Drawers, Nightstands
Chevets, Commodes
Cómodas, Mesitas de noche
Kommoden, Nachttische
Тумбочки, Комоды

PAGE	
64	CLUB
84	DANDY
48	DORIAN
56	DYNO
62	DYNO DESK
90	NIGEL

1
TABLES

cattelan
italia

CATTELANITALIA.COM



CATTELAN ITALIA SPA - via pilastri 19 - 36010 Carrè / Vicenza - Italy
phone +39 0445 318711 - fax +39 0445 314289 - email: info@cattelanitalia.com