

Arki Sofa

PEDRALI®

AS0010 - AS0111 - AS0012 - AS0020 - AS0121
AS0022 - AS0030 - AS0031 - AS0040

**100%
MADE IN
ITALY**

DESIGN
Pedrali R&D



EN: Sofa with polyurethane foam cushions with water-repellent fabric-covered cover. Extruded aluminium frame with elastic straps and stainless steel legs. S/steel tube and teak Ø40 mm backrest and armrests

IT: Divano con cuscini in schiumato poliuretano con fodera idrorepellente rivestita in tessuto. Struttura in estruso di alluminio con cinghie elastiche e gambe in acciaio inox. Schienale e braccioli in tubo in acciaio inox e teak Ø40 mm

DE: Sofa mit Polyurethanschaum-Kissen mit wasserabweisendem Stoffbezug. Gestell aus stranggepresstem Aluminium mit elastischen Bändern und Beinen aus rostfreiem Stahl. Rückenlehne und Armlehnen aus Stahlrohr und Teakholz Ø40 mm

FR: Canapé avec coussins en mousse de polyuréthane avec revêtement en tissu hydrofuge. Structure en aluminium extrudé avec sangles élastiques et pieds en acier inoxydable. Dossier et accoudoirs en tube d'acier inoxydable et teck Ø40 mm

ES: Sofá con cojines de espuma de poliuretano con funda de tela repelente al agua. Marco de aluminio extruido con correas elásticas y patas de acero inoxidable. Respaldo y reposabrazos de tubo de acero inoxidable y teca de Ø40 mm

mm - in

• AS0010

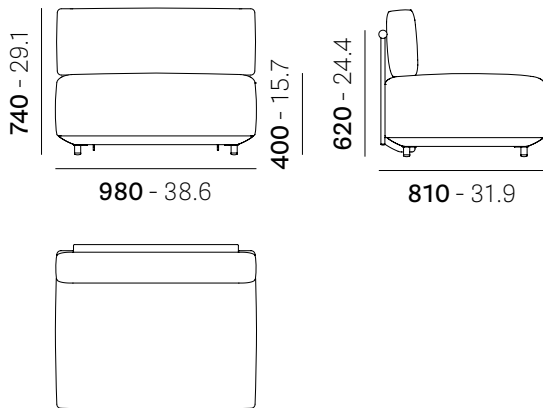

Disassembled
Da assemblare

mc 0,6
ft³ 21.1

20,5 kg
lb 45.1

• AS0111

EN: Possibility of mounting the armrest on either the right or left side
IT: Possibilità montaggio bracciolo sia a destra che a sinistra

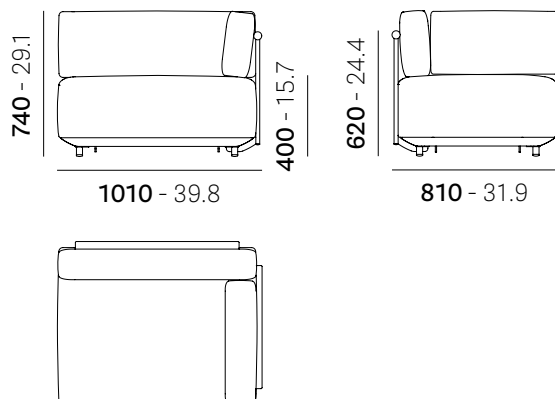

Disassembled
Da assemblare

mc 0,64
ft³ 22.6

24 kg
lb 53

Pedrali SpA Domestic Sales Dept. +39 035 835 88 10 Export Dept. +39 035 835 88 40 www.pedrali.it - info@pedrali.it



UNI EN ISO 14001:2015
Nr.50 100 13921 Rev.004
Environmental management system
Sistema di gestione ambientale



UNI EN ISO 9001:2015
Nr.50 100 13442 Rev.004
Quality management system
Sistema di gestione della qualità



UNI ISO 45001:2018
Nr.50 100 16933 Rev.001
Occupational health and safety management system
Sistema di gestione sicurezza e salute dei lavoratori



UNI EN ISO 14064-1:2019
Verification Statement nr. 79879
Corporate carbon footprint
Misura delle emissioni di gas serra

Reproduction of this document is strictly prohibited without prior written authorisation from Pedrali SpA. Sizes, weights and finishes may change without previous notice. È vietata la riproduzione del seguente documento senza previa autorizzazione scritta da parte di Pedrali SpA. Dimensioni, pesi e finiture possono variare senza alcun preavviso.

ST_ARKI-SOFA_AS_2024-0

Arki Sofa

PEDRALI®

AS0010 - AS0111 - AS0012 - AS0020 - AS0121
AS0022 - AS0030 - AS0031 - AS0040

DESIGN
Pedrali R&D

• AS0012

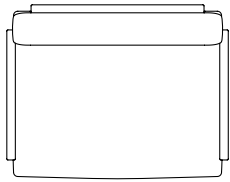
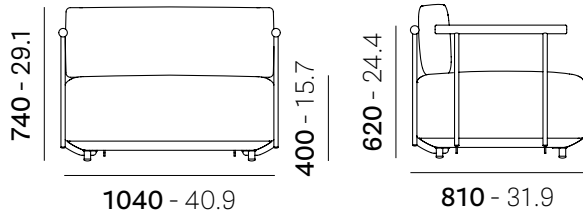

Disassembled
Da assemblare

mc 0,6
ft³ 21.1

25 kg
lb 55.1

• AS0020

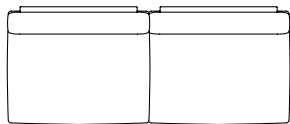
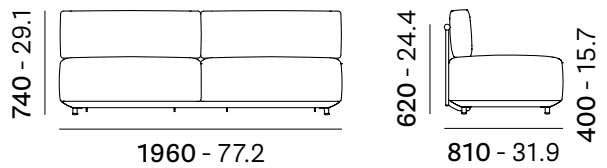

Disassembled
Da assemblare

mc 1,17
ft³ 41.3

44 kg
lb 97

• AS0121

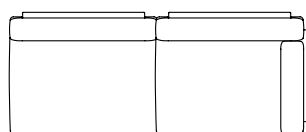
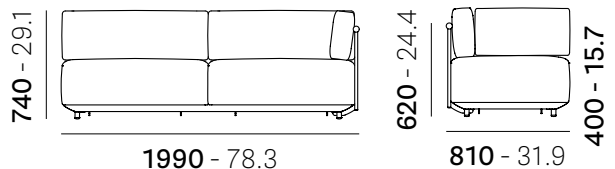

Disassembled
Da assemblare

mc 1,21
ft³ 42.7

47,5kg
lb 104.7

EN: Possibility of mounting the armrest on either the right or left side
IT: Possibilità montaggio bracciolo sia a destra che a sinistra



Arki Sofa

PEDRALI®

AS0010 - AS0111 - AS0012 - AS0020 - AS0121
AS0022 - AS0030 - AS0031 - AS0040

DESIGN
Pedrali R&D

• AS0022

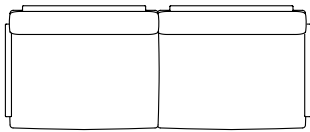
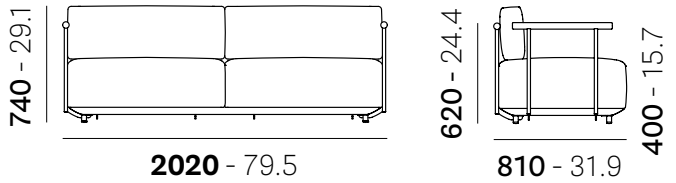

Disassembled
Da assemblare

mc 1,17
ft³ 41.3

48,5 kg
lb 107

• AS0030

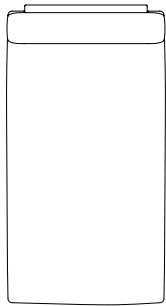
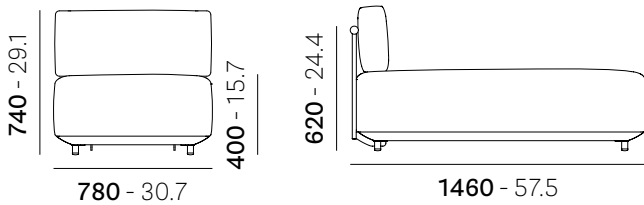

Disassembled
Da assemblare

mc 0,85
ft³ 30

30,5 kg
lb 67.2

• AS0031

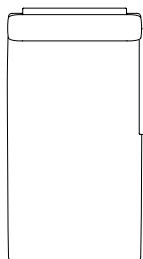
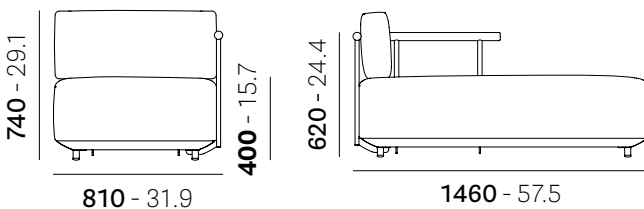

EN: Possibility of mounting the armrest on either the right or left side
IT: Possibilità montaggio bracciolo sia a destra che a sinistra



Disassembled
Da assemblare

mc 0,85
ft³ 30

33 kg
lb 72.7



AS0010 - AS0111 - AS0012 - AS0020 - AS0121
AS0022 - AS0030 - AS0031 - AS0040

DESIGN
Pedrali R&D

• AS0040

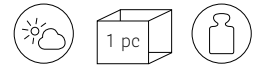
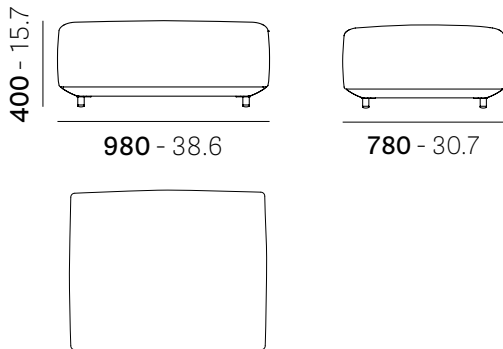

Disassembled **mc 0,6** **16,5 kg**
Da assemblare ft³ 21.1 lb 36.3

MATERIALS

Materiali
Materialien
Matériaux
Materiales

• SEAT CUSHION - CUSCINO SEDUTA - SITZKISSEN - COUSSIN DE ASSISE - COJÍN DEL ASIENTO

EN: Seat cushions padded with expanded flexible polyurethane (density 40 kg/m³), fire-retardant (certified 11M, Crib 5) with a water-repellent lining and covered with fabric

IT: Cuscini sedile, imbottiti con poliuretano espanso (densità 40 kg/m³), ignifugo (classe 1 IM, Crib 5) con fodera idrorepellente per esterno e rivestito in tessuto

DE: Sitzkissen gepolstert mit flexiblem Polyurethan (Dichte 40 kg/m³), feuerfest (Klasse 1 IM, Crib 5) mit wasserdichtem Futter für den Außenbereich und mit Stoff bezogen

FR: Coussins de assise rembourrée en polyuréthane expansé flexible (densité 40 kg/m³), ignifuge (classe 1 IM, Crib 5) avec doublure déperlante pour l'extérieur et recouverte d'un tissu

ES: Cojines asiento tapizado de espuma de poliuretano flexible (densidad 40 kg/m³), ignífugo (clase 11M, Crib 5) con funda repelente al agua para exterior y tapizados con tejido

• BACKREST CUSHION - CUSCINO SCHIENALE - RÜCKENLEHNENPOLSTER - COUSSIN DU DOSSIER - COJÍN DEL RESPALDO

EN: Back cushions padded with expanded flexible polyurethane (density 30 kg/m³) with a water-repellent lining and covered with fabric

IT: Cuscini schienale, imbottiti con poliuretano espanso (densità 30 kg/m³), ignifugo (classe 1 IM, Crib 5) con fodera idrorepellente per esterno e rivestito in tessuto

DE: Rückenkissen mit flexiblem Polyurethan (Dichte 30 kg/m³), feuerfest (Klasse 1 IM, Crib 5) mit wasserdichtem Futter für den Außenbereich und mit Stoff bezogen

FR: Coussins de dossier rembourrée en polyuréthane expansé flexible (densité 30 kg/m³), ignifuge (classe 1 IM, Crib 5) avec un doublure déperlante pour l'extérieur et recouverte d'un tissu

ES: Espuma de respaldo tapizado de espuma de poliuretano flexible (densidad 30 kg/m³), ignífugo (clase 11M, Crib 5) con funda repelente al agua para exterior y tapizados con tejido

FABRIC - TESSUTO - STOFF - TISSU - TEJIDO

Cat. D22÷D26 - D80÷D89 - D100÷D105 - D110÷D115 - D130÷D133 - D140÷D144

EN: For more information see finishing legend on the website

IT: Per maggiori informazioni vedere legenda finiture sul sito web

• BACKREST SUPPORT - SUPPORTO SCHIENALE - RÜCKENSTÜTZE - SUPPORT DOSSIER - SOPORTE RESPALDO

EN: Stainless steel frame, Ø20 mm tube and Ø40 mm Teak wood bar

IT: Struttura in acciaio inox, tubo Ø20 mm e parte superiore in legno Teak Ø40 mm

DE: Gestell aus rostfreiem Stahl, Ø20 mm Rohr und Ø40 mm Teakholzstange

FR: Cadre en acier inoxydable, tube de Ø20 mm et barre de teck de Ø40 mm

ES: Marco de acero inoxidable, tubo de Ø20 mm y barra de madera de teca de Ø40 mm

• FRAME - TELAIO - GESTELL - STRUCTURE - ESTRUCTURA

EN: Aluminium extrusion with elastic belts

IT: Alluminio estruso con cinghie elastiche

DE: Aluminium extrudiert mit elastischen Gurten

FR: Aluminium extrusion avec sangles élastiques

ES: Aluminio extrusión con cinchas elásticas

Reproduction of this document is strictly prohibited without prior written authorisation from Pedrali Spa. Sizes, weights and finishes may change without previous notice. È vietata la riproduzione del seguente documento senza previa autorizzazione scritta da parte di Pedrali Spa. Dimensioni, pesi e finiture possono variare senza alcun preavviso.

AS0010 - AS0111 - AS0012 - AS0020 - AS0121
AS0022 - AS0030 - AS0031 - AS0040

DESIGN
Pedrali R&D

• LEGS - GAMBE - FÜßE - PIEDS - PATAS

EN: Stainless steel, tube Ø30 mm
IT: Acciaio inox, tubo Ø30 mm
DE: Rostfreier Stahl, Rohr Ø30 mm
FR: Acier inoxydable, tube Ø30 mm
ES: Acero inoxidable, tubo Ø30 mm

LEGS FINISH - FINITURA GAMBE - FÜßE AUSFÜHRUNG - PIEDS FINITION - ACABADO DE LAS PATAS

EN: Powder coating
IT: Verniciato con polvere
DE: Pulverbeschichtet
FR: Époxy à poudre
ES: Barnizado con polvo



EN: For full range of color available see finishing legend on the website
IT: Per tutta la gamma di colori disponibili vedere legenda finiture sul sito web

• FEET - PIEDINI - GLEITER - PATINS - TACOS

EN: Technopolymer feet, black
IT: Piedino in tecnopolimero, nero
DE: Gleiter Technopolymer, Schwarz
FR: Patis en technopolymère, noir
ES: Tacos en tecnopolimero, negro

ACCESSORIES

Accessori
Zubehör
Accessoires
Accesorios

EN: Optional outdoor cushions can be inserted
IT: Possibilità di inserire cuscini opzionali per esterno
DE: Optionale Outdoor-Kissen können eingelegt werden
FR: Des coussins d'extérieur peuvent être insérés en option
ES: Se pueden insertar cojines de exterior opcionales

COVER001 - COVER003 - COVER005

EN: Protective cover
IT: Copertura protettiva
DE: Schutzhülle
FR: Couverture protectrice
ES: Cubierta protectora

AS_LINK

EN: Connecting hook
IT: Gancio di collegamento
DE: Verbindungshaken
FR: Crochet de connexion
ES: Gancho de conexión

Reproduction of this document is strictly prohibited without prior written authorisation from Pedrali SpA. Sizes, weights and finishes may change without previous notice.
 È vietata la riproduzione del seguente documento senza previa autorizzazione scritta da parte di Pedrali SpA. Dimensioni, pesi e finiture possono variare senza alcun preavviso.

AS0010 - AS0111 - AS0012 - AS0020 - AS0121
AS0022 - AS0030 - AS0031 - AS0040

DESIGN
Pedrali R&D

REGULATIONS AND CERTIFICATES

Normative e Certificazioni
Bestimmungen und Zertifikat
Normatives et certifications
Normativas y certificados

• PRODUCT CERTIFICATIONS - CERTIFICAZIONI DI PRODOTTO - PRODUKTZERTIFIZIERUNGEN - CERTIFICATIONS DE PRODUITS - CERTIFICACIONES DE PRODUCTO

EN: FSC® certified product
IT: Prodotto certificato FSC®
DE: Zertifiziertes Produkt FSC®
FR: Produit certifié FSC®
ES: Producto certificado FSC®



• ENVIRONMENTAL IMPACT - IMPATTO AMBIENTALE - UMWELTBELASTUNG - IMPACT DUR L'ENVIRONNEMENT - IMPACTO AMBIENTAL

| MATERIAL Materiale | WEIGHT (Kg) Peso (Kg) | % TOTAL ITEM % totale articolo | MATERIAL RECYCLABILITY Riciclabilità del materiale | % RECYCLED AT ORIGIN % riciclato all'origine | % RECYCLABLE END OF PRODUCT LIFE % riciclabile fine vita prodotto |
|------------------------------------------|--------------------------|-----------------------------------|-------------------------------------------------------|-------------------------------------------------|----------------------------------------------------------------------|
| Steel Acciaio | 8,8 | 18,2 | YES | 33,2 | 100 |
| Extruded aluminium Alluminio estruso | 11,2 | 23,1 | YES | 100 | 100 |
| Zamak Zama | 0,3 | 0,6 | YES | 50 | 100 |
| Technopolymer Tecnopolimero | 0,04 | 0,1 | YES | 40 | 100 |
| Polyethylene Polietilene | 2,8 | 5,8 | YES | 0 | 100 |
| Polyurethane foam Poliuretano espanso | 21,5 | 44,3 | NO | 0 | 0 |
| Teak Teak | 2,27 | 4,7 | YES | 0 | 100 |
| Fabric Tessuto | 1,58 | 3,2 | NO | 0 | 0 |
| TOTAL TOTALE | 48,5 Kg | -- | -- | 29,5 % | 52,4 % |

EN: Percentages referred to AS0022
IT: Percentuali riferite a AS0022

Reproduction of this document is strictly prohibited without prior written authorisation from Pedrali SpA. Sizes, weights and finishes may change without previous notice.
 È vietata la riproduzione del seguente documento senza previa autorizzazione scritta da parte di Pedrali SpA. Dimensioni, pesi e finiture possono variare senza alcun preavviso.

