

MODULOR

Design Pio e Tito Toso

MODULOR PL 3



MODULOR PL 3

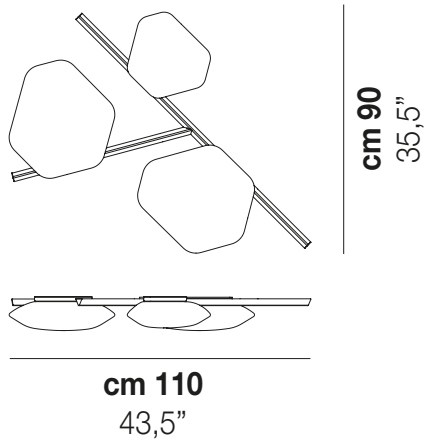

DATOS TÉCNICOS:



LED 2700K DIM2	1x12W+2x39W	220-240 V 50/60 Hz
LED 2700K DIM3	1x12W+2x39W	220-240 V 50/60 Hz
LED 3000K DIM2	1x12W+2x39W	220-240 V 50/60 Hz
LED 3000K DIM3	1x12W+2x39W	220-240 V 50/60 Hz

CERTIFICATIONS:



Led 2700 K 12W+2x19W 24+39+39 V 7400 lm DIM2 Phase Cut
Led 2700 K 12W+2x19W 24+39+39 V 7400 lm DIM3 0-10V, Push
Led 3000 K 12W+2x19W 24+39+39 V 7400 lm DIM2 Phase Cut
Led 3000 K 12W+2x19W 24+39+39 V 7400 lm DIM3 0-10V, Push

VOLUME	Mc 0,56
PESO BRUTO	Kg 17
PESO NETO	Kg 12

download



ACABADO DEL DIFUSOR



BCST

ACABADO PARTES METÁLICAS

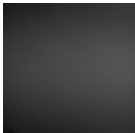

NEO



OTV

OTRAS VERSIONES DISPONIBLES

Haga clic en la versión para ir a la versión web del producto

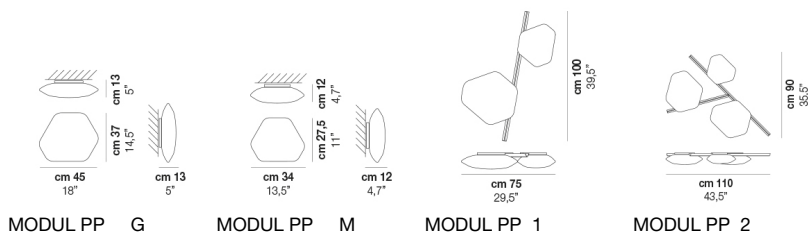

MODULOR PP G

MODULOR PP M

MODULOR PP 1

MODULOR PP 2