

Discover our collection of seats,
tables, complements and shelving.

2021-2022

Mobles114

01	Seats	p. 06
02	Tables	p. 49
03	Complements	p. 83
04	Tria Shelving	p. 115

Seats

08



Gràcia

11

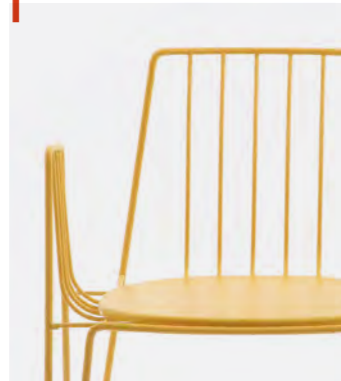

Rambla

13

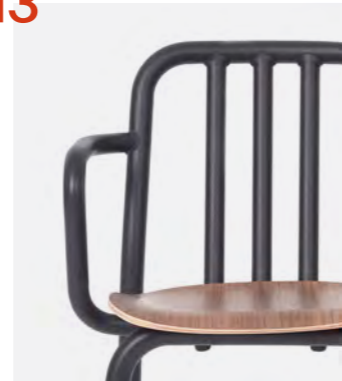

Tube

16

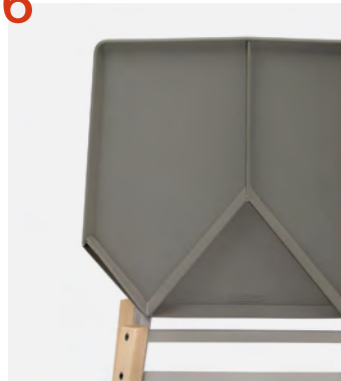

Green eco

18



Green colors

21

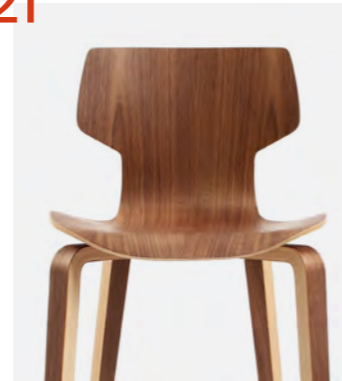

Gràcia stool

23



Tube stool

25

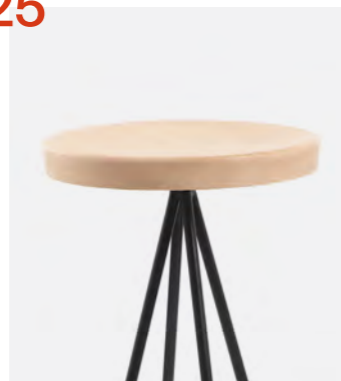

Nuta

27

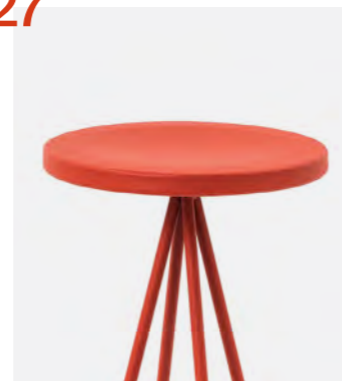

Nuta Colors

29

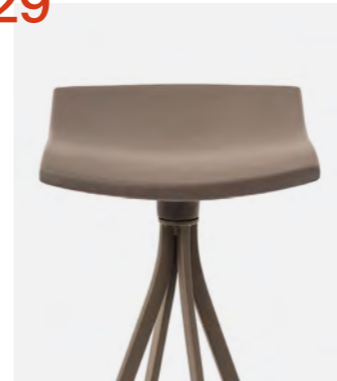

Gimlet stool

31

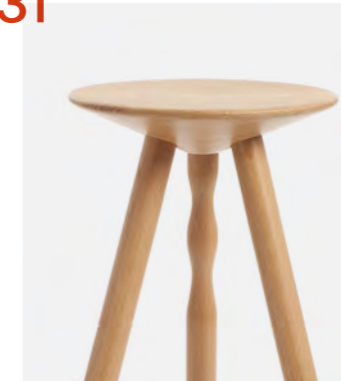

Luco

33



Flod

36



Om

39

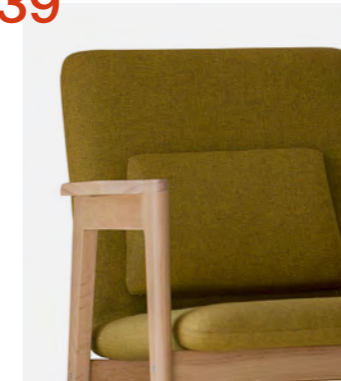

Danesa

41

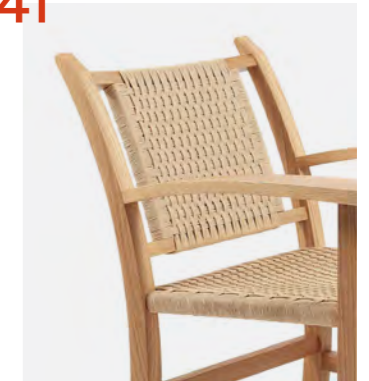

Torres Clavé 1934

45



Catalana 1942

Tables



Gràcia



Rambla

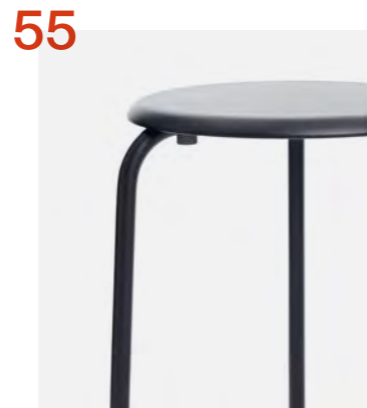

Tube



MMS 1963

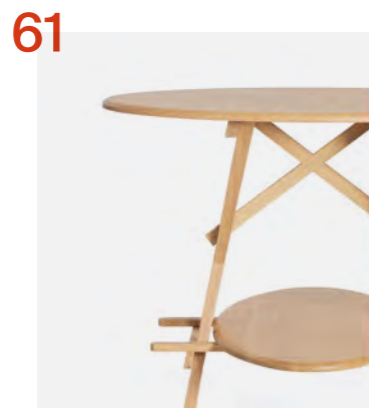

Jujol 1920

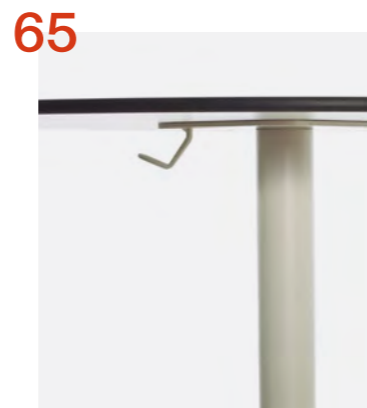

Oxi bistrot



Pey central



Pey table system

Complements

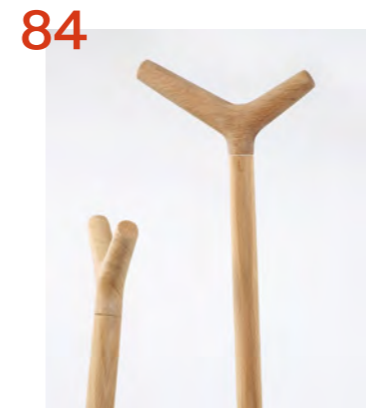

Forc

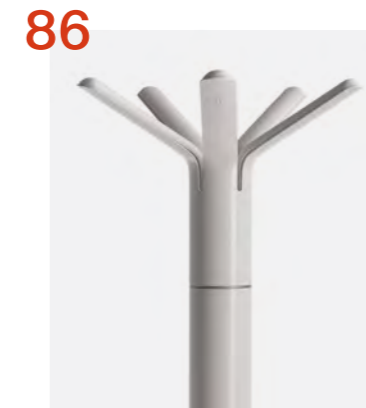

Hulot



Taiga



Mirac

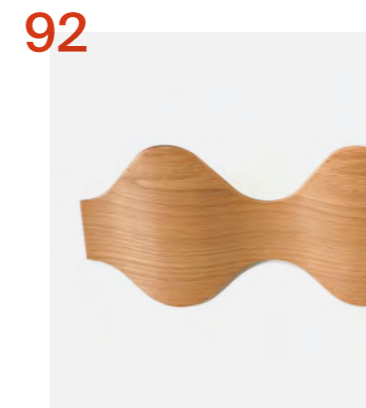

Ona



Bambú



Riga



Tombal



Platea

Complements



Fil 1991



Copenhaguen 1966



Tong 1964

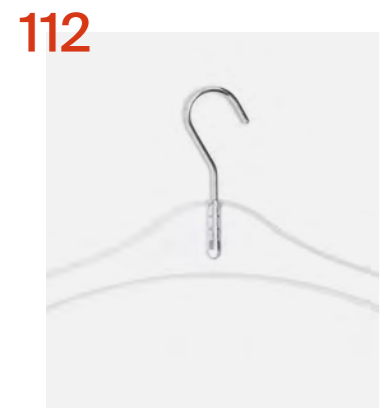

Frac



Circus

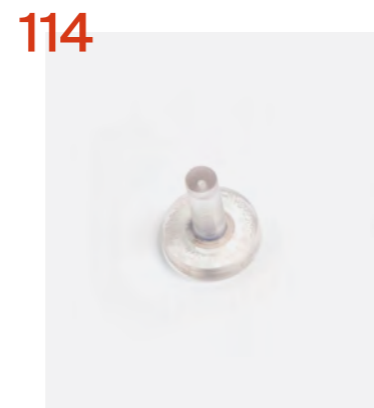

Clac

Tria Shelving

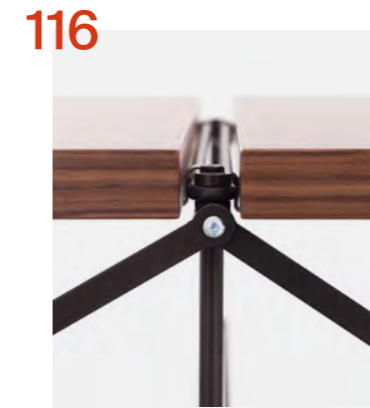

Tria shelving System



SEATS



CHAIRS

Gràcia



08

Design by Massana - Tremoleda



Chairs, tables and stools

ENG The Gràcia family is made up of chairs, tables and stools in their different versions. The collection is produced using top quality plywood and noble woods, its finishes and solid materials making it particularly hardwearing, long-lasting and suitable for intensive use.

Sillas, mesas y taburetes

ESP La familia Gràcia está formada por sillas, mesas y taburetes en diferentes versiones. Es una colección fabricada con contrachapado y maderas nobles de primera calidad. Los acabados y solidez del material hacen que la colección sea especialmente resistente, perdurable y adecuada para un uso intenso.



A wide range of select fabrics allows the chairs to be upholstered, adding comfort and colour to the collection.



ENG All the details have been especially designed: felt glides for the feet to minimise noise, a curved back for additional comfort and a polyurethane foam cushion easy to clean and ideal for public areas. A wide range of select fabrics allows the chairs to be upholstered, adding comfort and colour to the collection.

ESP Todos los detalles han sido especialmente pensados: tacos de fieltro en las patas para amortiguar el ruido, una curva en el respaldo que aporta un gran confort o un cojín de espuma de poliuretano ideal para sitios de uso público ya que es fácil de limpiar. Una amplia gama de telas seleccionadas permiten tapizar las sillas para añadir confort y color a la colección.

Rambla





ENG The Rambla chair takes its conceptual inspiration from the seats used in one of the most emblematic streets in the city of Barcelona: The Rambla. A street that runs from the very heart of the city to the waters of the port. A road that used to have seats you could hire for a while, to have a rest or a chat, very often turning into an improvised agora.

ESP La silla Rambla se inspira conceptualmente en las sillas que albergaba antiguamente uno de los paseos más emblemáticos de la ciudad de Barcelona: la Rambla. Un paseo que discurre desde el centro neurálgico de la ciudad hasta las aguas del puerto; una calle en la que había sillas de alquiler, donde sentarse para descansar o conversar, y que a menudo se convertía en ágora improvisada.

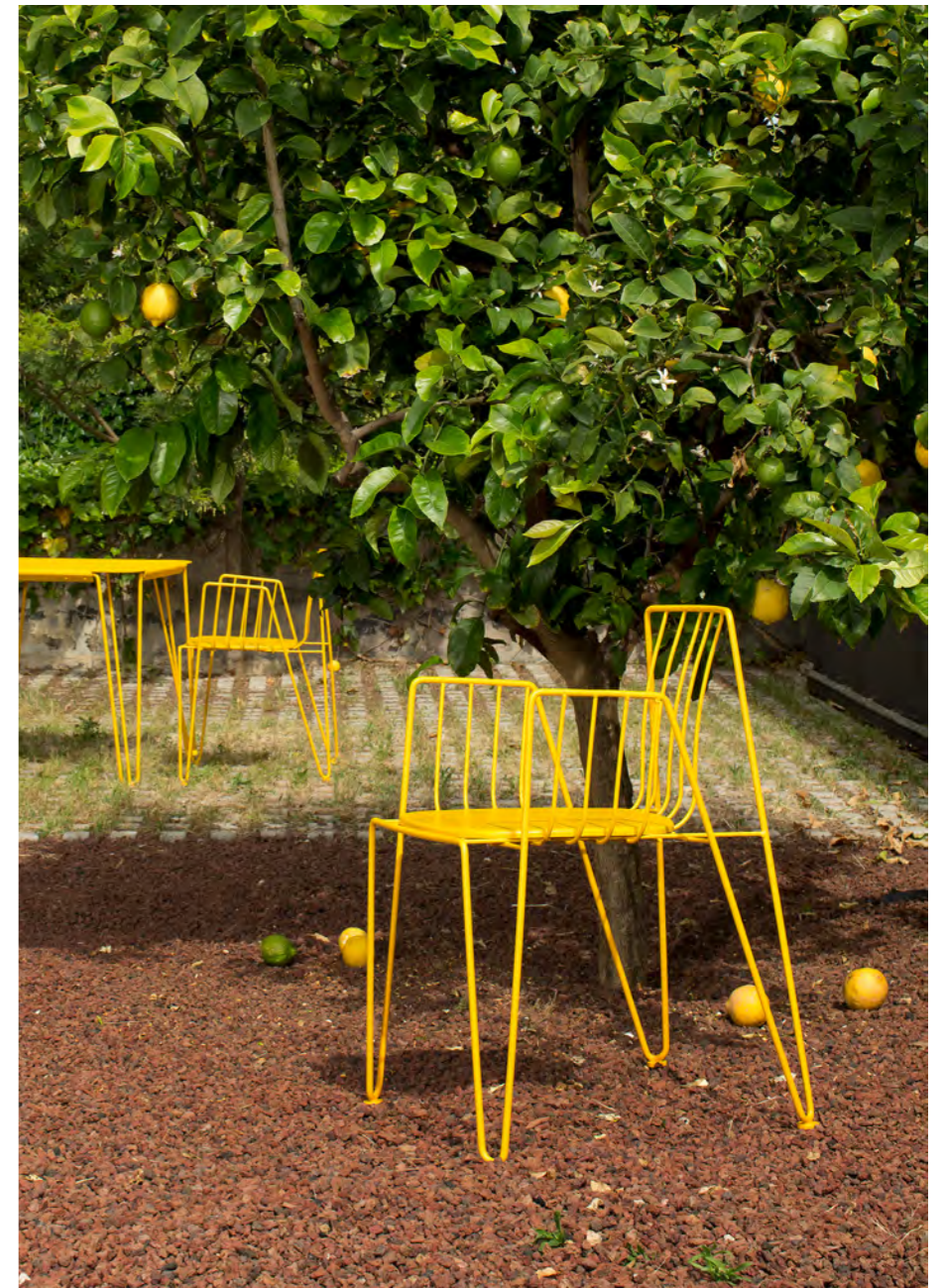

**Color finishes available
in yellow, green, white or black.**

Check technical information (pag. 139)

Tube



Design by Eugeni Quitllet





**Wood finishes available
in oak or walnut**
Check technical information (pag. 139)

Green eco



ENG The Green eco chair is a project born with the commitment to improve people's quality of life and the environment. Aware of this value, Mobles 114 and Javier Mariscal have interpreted and added originality to a propylene chair produced with 100% recycled and recyclable materials: polypropylene coming from industrial waste.

ESP La silla Green eco es un proyecto que nace con el compromiso de mejorar la calidad de vida y el medio ambiente. Sensibles a este valor, Mobles 114 y Javier Mariscal han interpretado y aportado originalidad a una silla de polipropileno producida con material 100% reciclado y 100% reciclable, procedente de residuos industriales.

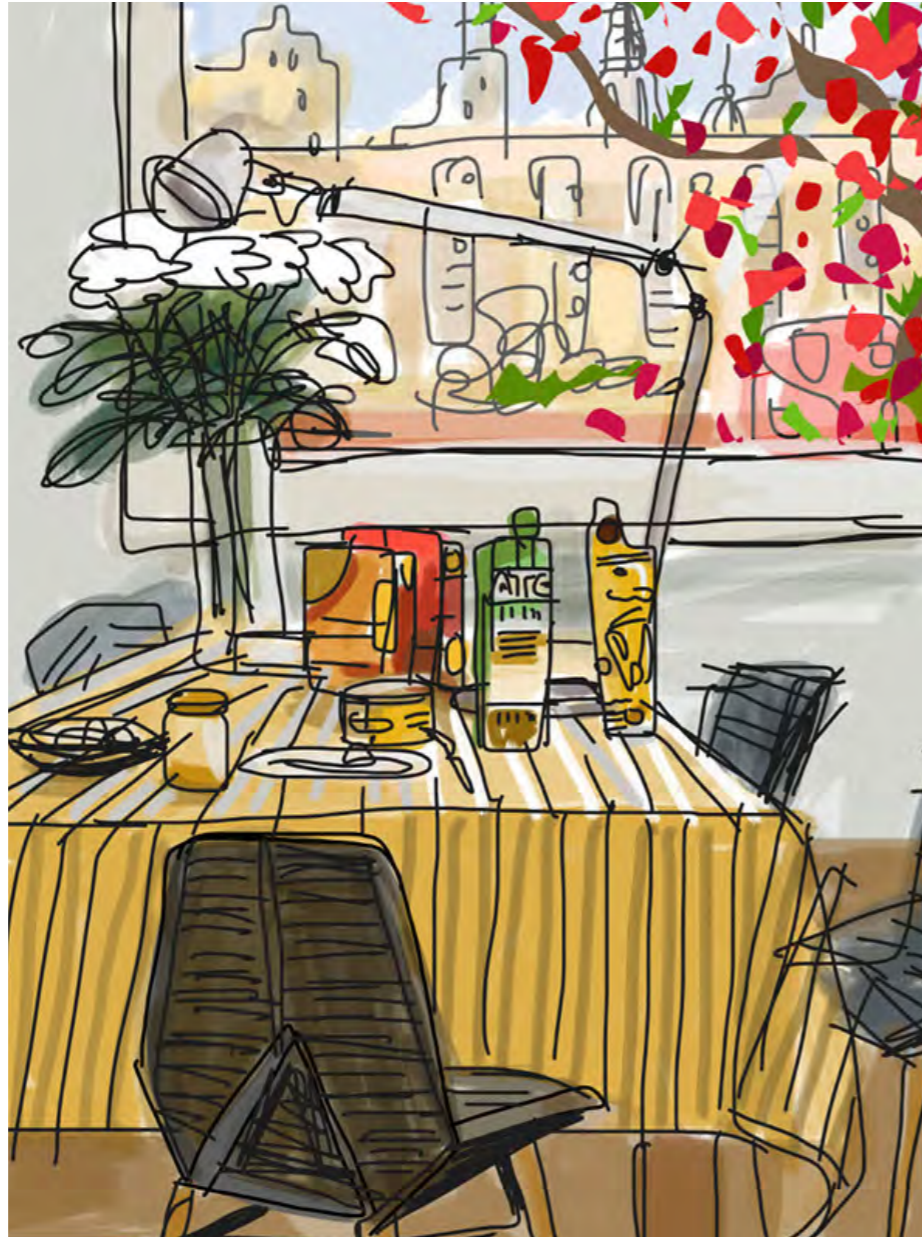

Sketches by Javier Mariscal



100% recycled and 100% recyclable materials.
polypropylene from industrial waste.

Green colors



18

Design by Javier Mariscal



ENG The seat of this polypropylene chair is available in a range of tones that soften and transform its appearance, adapting to different decors. It's ideal for livening up as bar or restaurant chair or also as living room or kitchen chair. The Green wooden chair is available in four colours.

ESP El asiento de esta silla de polipropileno está disponible en diversos tonos que suavizan y transforman su apariencia, adaptándose a diferentes estilos de decoración. Es ideal para dar dinamismo como silla de bar o restaurante y también como silla de comedor o cocina.



Finishes available in white,
orange, ochre and green
Check technical information (pag. 139)



STOOLS

Gràcia



21

Design by Massana - Tremoleda



**Wood finishes available
in oak or walnut**
Check technical information (pag. 140)

Tube

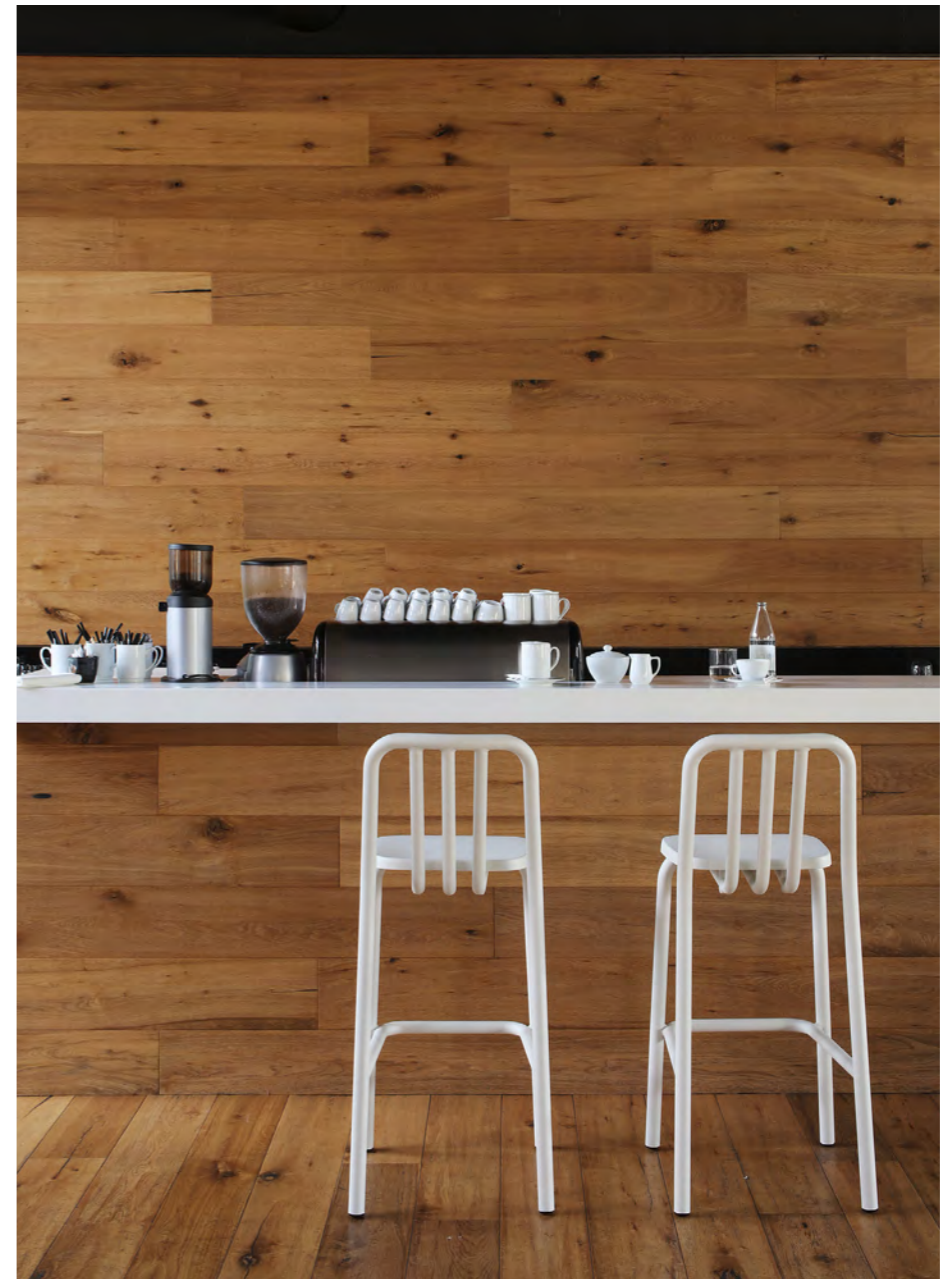

23

Design by Eugeni Quitllet

Tube is a comfortable, large-sized stool, stable and hardwearing, that adapts well to all kinds of spaces.

ENG Tube is a comfortable, large-sized stool, stable and hardwearing, that adapts well to all kinds of spaces. It is perfect for restaurants, bars, cafeterias and also for homes. Ideal for tables in domestic kitchens that are used for both cooking and eating. Its polypropylene seat ensures great comfort and the frame, light but strong, also makes the Tube a suitable aluminium stool for outdoor use.

ESP Tube es un taburete de medidas amplias y confortable, estable y resistente que se adapta a todos los ámbitos. Óptimo para restaurantes, bares, cafeterías o para el hogar. Ideal para los mostradores de las cocinas domésticas donde cocinar y comer comparten el mismo espacio. El asiento de polipropileno garantiza un gran confort y la estructura, ligera y robusta, hace también que Tube se convierta en un taburete de aluminio apto para el exterior.





Nuta

25



ENG Nuta is a stool collection that stands out for its essential shape and lightness, as well as its adaptability to different interior designs. Nuta stools are especially suitable as catering stools, furnishing bars and cafeterías. It can also be used at home as a kitchen stool. It's very stable in spite of its light shape and can perfectly withstand intensive use.

ESP Nuta es una colección de taburetes que destacan por su forma esencial y ligereza y por adaptarse a diferentes diseños de interiores. Están especialmente indicados para la hostelería, ya que se integran en el equipamiento como taburetes de bares y cafeterías. También pueden formar parte del mobiliario del hogar como taburetes de cocina. Su ligereza formal no le resta en absoluto estabilidad.



Finishes available in a wide range of options
Check technical information (pag. 140)



Nuta Colors





Its monochromatic structure and seat are specially treated and painted to withstand outdoor use.



Color finishes available in 4 colors.
Check technical information (pag. 140)

Gimlet



29

Design by Jorge Pensi



Gimlet stool with swivel seat

ENG The Gimlet swivel stool is made up of a polyurethane foam swivel seat and a painted steel structure with a chrome foot rest. Adapts to a range of spaces, architectural and interior styles. This light, comfortable stool is available in four colours.

Taburete Gimlet con asiento giratorio

ESP El taburete giratorio Gimlet está formado por un asiento de espuma de poliuretano y una estructura de acero pintada con reposapiés cromado. Por sus líneas, se adapta a múltiples espacios y estilos arquitectónicos y de interiorismo. Es un taburete ligero y cómodo y, como su versión silla, está disponible en cuatro colores.





Luco



31

Design by Martín Azúa



"I am very interested in working with local resources and claim materials and technologies diversity, including both innovation and tradition. I do not like the idea of a uniform world where products have an unclear origin and are made of materials that we do not recognize".

"Estoy muy interesado por trabajar con recursos locales y reivindicar una diversidad material y tecnológica. En la que evidentemente entra lo nuevo pero sin perder lo tradicional. No me gusta la idea de un mundo uniformizado, donde los productos tienen una procedencia poco clara y están hechos de materiales que no reconocemos."

Martín Azúa



Flod

33

Design by Martín Azúa & Gerard Moliné



ENG Flod is a design stool created by Azúa-Moliné for Mobles 114, made from polyethylene and designed for both indoor and outdoor use. An unmistakably original, colourful and ergonomic stool, light but hardwearing and designed to withstand intensive use and all kinds of weather. It is perfect for bars, cafeterias, catering areas, hotels, terraces, gardens and other special locations.

ESP Flod es un taburete de diseño creado por Azúa-Moliné para Mobles 114, realizado en polietileno y pensado indistintamente para uso interior y exterior. Su diseño contundente, original, el colorido y la ergonomía, la ligereza y la resistencia al uso intensivo y la climatología, lo convierten en un taburete especialmente indicado para el equipamiento de bares, cafeterías, espacios de restauración, hostelería, terrazas, jardines y otros espacios singulares.



Color finishes available in three different colours

Check technical information (pag. 141)



ARMCHAIRS



Om

36

Design by Martín Azúa



**Its designer, Martín Azúa,
has explored ergonomic
possibilities in a sculptural,
single-block armchair that
also has smooth, light lines.**

ENG The Om armchair is extremely light, comfortable and easy to transport. This is a remarkable, clever lounge chair that adjusts its fine, smooth lines to the volume of a large armchair. Designed for a range of uses, it's perfect for receptions and hotel lobbies as well as for placing around tables at restaurants or in meeting rooms and also for several areas in the home.

ESP La butaca Om basic es extremadamente ligera, cómoda y fácil de transportar. De líneas finas y suaves, su volumen ajustado a las dimensiones de una silla grande la convierte en una butaca singular e inteligente. Pensada para múltiples usos, es idónea para salas de recepción y vestíbulos de hotel, y adecuada para colocar alrededor de las mesas en un restaurante o en salas de reuniones y, también, para diversas áreas del hogar.



Danesa



39

Design by Massana - Tremoleda



ENG Danesa is a very comfortable armchair. Inspired in the nordic design, it has a clearly contemporanean style following the tradition and mediterranean shapes.

ESP Danesa es una butaca de gran confort. Un diseño que, inspirado en los diseños nórdicos, tiene un estilo claramente contemporáneo, siguiendo la tradición y formas mediterráneas.

Torres Clavé 1934



ENG The Torres Clavé armchair takes its inspiration from the traditional chairs of Ibiza. It is made of an open oak frame, and a seat and backrest hand-woven with twisted paper cord.

ESP La butaca Torres Clavé se inspira en la tradicional sillería ibicenca. De estructura de madera de roble y asiento y respaldo tejidos con cuerda de papel de manufactura artesanal.



Back upholstered in traditionally made paper cord.

Check technical information (pag. 141)



Classic Collection

Josep Torres Clavé

Barcelona 1906 - Els Omellons 1939

ENG Architect, urban developer, designer and pedagogue, he was a founding member of GATPAC (Group of Spanish Artists and Technicians for the Progress of Contemporary Architecture) and a leading introducer of rationalist architecture in our country.

Torres Clavé started his career in architecture together with Josep Lluís Sert and Antoni Bonet Castellana. In fact, with Josep Lluís Sert and Joan Baptista Subirana he constructed some of the most important buildings in Catalan rationalism, such as the Ciutat de Repós i Vacances in Castelldefels (1932) and the Dispensari General Antituberculós in Barcelona (1936).

He ran the magazine AC (A. C. Documents of Contemporary Activity), helping to introduce artists such as Le Corbusier, Walter Gropius, Mies van der Rohe, Erich Mendelsohn, Van Doesburg, Neutra, Lubetkin, Joan Miró and Pablo Picasso; working to spread architecture, design and contemporary art in a society wanting to modernise, in competition with a supremely contemporary Europe. He left behind a brief but important legacy in his short career as a designer.

He designed chairs, tables and lights, among other items of furniture, including the Torres Clavé armchair, released by Mobles 114.

Josep Torres Clavé died aged 33 during the Spanish Civil War.

ESP Arquitecto, urbanista diseñador y pedagogo. Miembro fundador del GATCPAC (Grupo de Artistas y Técnicos Catalanes para el Progreso de la Arquitectura Contemporánea) e introductor destacado de la arquitectura racionalista en nuestro país.

Inició su trayectoria como arquitecto junto a Josep Lluís Sert y Antoni Bonet Castellana. Precisamente con Sert y Joan Baptista Subirana proyectó algunas de las obras más importantes del racionalismo catalán, como la Ciudad de Reposo y Vacaciones de Castelldefels (1932) o el Dispensario General Antituberculoso en la ciudad de Barcelona (1936).

Dirigió la revista AC (AC. Documentos de Actividad Contemporánea), desde la que introdujo a artistas como Le Corbusier, Walter Gropius, Mies van der Rohe, Erich Mendelsohn, Van Doesburg, Neutra, Lubetkin, Joan Miró o Pablo Picasso; una labor de difusión sobre arquitectura, diseño y arte contemporáneo en una sociedad que buscaba modernizarse y que competía con una contemporaneidad europea de primer orden. En su corta carrera como diseñador dejó una impronta, sin embargo, contundente.

Diseñó sillas, mesas y lámparas, entre otras piezas de mobiliario, entre las que destaca la butaca Torres Clavé, reeditada por Mobles 114.

Josep Torres Clavé murió a los 33 años de edad, durante la Guerra Civil española



Self-portrait (Josep Torres Clavé)

Torres Clavé armchair was exhibited at the International Exhibition in Paris in 1937 along with other world-renowned artworks such as Picasso's Guernica.



Pavilion of the Spanish Republic, International Exhibition in Paris 1937. Photo by François Kollar

ENG The architect Josep Torres Clavé designed this armchair in 1934 to furnish the Pavilion of the Spanish Republic at the 1937 International Exhibition in Paris, next to works such as Guernica by Pablo Picasso others by Alexander Calder and Joan Miró.

The Torres Clavé armchair takes its inspiration from the traditional chairs of Ibiza.

With an oak frame and its seat and back upholstered in traditionally made string, its traditional appearance adds a touch of elegance to spaces in hotels, receptions and waiting rooms, as well as reading areas in libraries and other special areas. A noble, minimalist Mediterranean wooden armchair that adds personality to the home.

It has formed part of the Permanent Collection at Barcelona's Design Museum since 1994. It's traditionally made and is one of the iconic pieces in the classics of international design.

ESP En 1934, el arquitecto Josep Torres Clavé diseñó este sillón de madera como parte del mobiliario que debía acoger el Pabellón de la República Española en la Exposición Internacional de París de 1937, junto al Guernica de Pablo Picasso y otras obras de Alexander Calder o Joan Miró.

La butaca Torres Clavé se inspira en la tradicional sillería ibicenca.

De estructura de madera de roble y asiento y respaldo tejidos con cuerda de manufactura artesanal, por su carácter formal es especialmente adecuada para ámbitos de hotelería, recepción o salas de estar y zonas de lectura en bibliotecas y otros espacios singulares. Es, además, una butaca particularmente cálida y natural para la decoración de interiores del hogar.

Forma parte de la Colección permanente del Museu del Disseny de Barcelona desde 1994. De producción artesanal, es una pieza emblemática e icónica que Mobles 114 fabrica desde que la reeditó en 1987.



Catalana 1942



45

Design by Germán Rodríguez Arias





Classic Collection

Germán Rodríguez Arias

Barcelona 1902 - 1987

ENG Catalan architect and designer, together with Josep Lluís Sert, Josep Torres Clavé, Sixte Illescas and Ricardo de Churruga, among others, he introduced architectural rationalism to Catalonia and was a founding member of GATCPAC. The buildings he designed in the city of Barcelona form part of the heritage of universal rationalist architecture.

During his exile in Mexico and subsequently in Chile, he focused his work on designing interiors and furniture; as a result of his very close relationship with the Chilean poet Pablo Neruda, Rodríguez Arias was the architect behind the various homes Neruda had built in Chile during his lifetime. Together with Cristián Aguadé and Claudi Tarragó he founded Muebles Sur, which would become one of the country's leading furniture makers. In 1957 he returned to his homeland and settled on Ibiza, once again getting together with his companions Sert, Prats and Illescas. He worked as a municipal architect on the island, combining this with projects as a private architect and principally designing hotels and homes, including his own house at Portinatx.



Germán Rodríguez Arias and his wife

ESP Arquitecto y diseñador catalán, introductor, con Josep Lluís Sert, Josep Torres Clavé, Sixt Illescas y Ricardo de Churruga, entre otros, del racionalismo arquitectónico en Cataluña y socio fundador del GATCPAC. Los edificios que proyectó en la ciudad de Barcelona forman parte del patrimonio de la arquitectura racionalista universal.

En su exilio en México y posteriormente en Chile centró su actividad en el diseño de interiores y de mobiliario.

En Chile forjó una estrecha relación con el poeta Pablo Neruda, que le llevó a proyectar sus sucesivas viviendas a lo largo de su vida. También en Chile, funda, junto con Cristián Aguadé y Claudi Tarragó, la empresa Muebles Sur, que se convertirá en una de las fábricas de muebles más importantes del país.

En 1957 regresa a su país natal y se instala en Ibiza, donde se reencuentra con Sert, Prats e Illescas. En Ibiza compaginará el cargo de arquitecto municipal con la actividad privada, proyectando principalmente hoteles y viviendas, entre las que destaca la suya, en Portinatx.

Rodríguez Arias design, among others, the extension of Isla Negra, Pablo Neruda's house in Chile, and part of the furniture such as the Catalan armchair.



Pablo Neruda's house in Chile. Photo by Diaz Wichmann

ENG During his time in Chile, German Rodríguez Arias met Pablo Neruda and struck up a long-lasting friendship with him. The poet asked him to design some of the houses he had built while he was in Chile. Among others, Rodríguez Arias designed the house at Chascona and the extension of Isla Negra, two of the poet's homes.

This Catalan armchair formed part of the series of furniture placed by the architect and designer in the Isla Negra house. The armchair was made with local wood from Chile and rushes, taking its inspiration from traditional Catalan armchairs.

Mobles 114 has revived the Catalan armchair by Rodríguez Arias made of oak with its seat upholstered in traditionally made natural fibre, respecting as scrupulously as possible the original design by German Rodríguez Arias. A wooden chair with a markedly Mediterranean character that is particularly notable for having six legs, a high back and a slant reinforced by the back legs, giving the piece a contemporary, modern feel.

ESP Durante su etapa chilena, Germán Rodríguez Arias conoció a Pablo Neruda, con quien mantendría una larga amistad. El poeta le encargaría la construcción de las diversas casas que edificó a lo largo de sus estancias en Chile.

Rodríguez Arias proyectó, entre otras, la casa La Chascona y la ampliación de Isla Negra, dos de las viviendas del poeta. La butaca Catalana formó parte del mobiliario que el arquitecto y diseñador proyectó para Isla Negra. La fabricó con madera autóctona de Chile y boga, inspirándose en las butacas tradicionales catalanas.

Mobles 114 ha reeditado la butaca Catalana de Rodríguez Arias con madera de roble y asiento tejido de fibra natural de manufactura artesanal, respetando lo más escrupulosamente posible el diseño original. Una sillón de madera de naturaleza marcadamente mediterránea que destaca por sus seis patas, su alto respaldo y una inclinación reforzada por las patas posteriores, factores que le confieren un carácter actual y moderno.





TABLES

Gràcia



50

Design by Massana - Tremoleda





Up to 60 different dimensions to fit every space.

Rectangular formats

	120	130	140	150	160	170	180	190	200	220
80	●	●	●	●	●	●	●	●	●	●
85	●	●	●	●	●	●	●	●	●	●
90	●	●	●	●	●	●	●	●	●	●
100	●	●	●	●	●	●	●	●	●	●

Square formats

	80	90	100	110	120
80	●				
90		●			
100			●		
110				●	
120					●

Circular formats

	80	90	100	110	120
80	●				
90		●			
100			●		
110				●	
120					●

Round, square and rectangular table tops with power connection.



Rambla

53

Design by Martín Azúa



ENG This metallic coffee table completes the Rambla collection; made from the same materials as the chair, it's perfect for terraces, porches and gardens as patio table. Its square shape and light lines, with four formally elegant legs, identify it naturally with the Mediterranean culture in which sharing a meal or conversation and coffee around such a table forms an essential part of the way of life.

ESP Esta mesa metálica completa la colección Rambla; está fabricada con los mismos materiales que la silla y es ideal para terrazas, porches y como mesa de jardín. Las mesas cuadradas Rambla, de líneas ligeras, con cuatro patas formalmente elegantes, se identifican naturalmente con una cultura, la mediterránea, en la que compartir una comida o una conversación y un café en torno a una mesa es parte del saber vivir y una manera de relacionarse.



Tube



55

Design by Eugeni Quitllet



MMS 1963



57

Design by Miguel Milá





Classic Collection

Miguel Milá
Barcelona, 1931

ENG Miguel Milá, who started his career in the late 1950s, sees himself as a pre-industrial designer. Together with André Ricard, Antoni de Moragas, Oriol Bohigas and Rafael Marquina, among others, he was the co-founder of the ADI FAD association, set up to promote and disseminate industrial design both nationally and internationally.

His work as an interior designer for the studio of Federico Correa and Alfonso Milá stands out, remarkably, for its ability to impart comfort and elegance to the spaces he creates.

His designs are the result of painstaking but seemingly simple work which has led to many of his products being recognised as icons of our country's industrial design. He won the very first National Design Award in 1987, Compasso d'Oro and Gold Medal for Fine Arts 2016.



ESP Miguel Milá, que inició su carrera a finales de los años 50, se considera a sí mismo un diseñador preindustrial. Junto con André Ricard, Antoni de Moragas, Oriol Bohigas o Rafael Marquina, entre otros, fue cofundador de la asociación ADI-FAD, creada para promover y difundir el diseño industrial a nivel nacional e internacional.

Su labor como diseñador de interiores en el despacho de Federico Correa y Alfonso Milá destaca especialmente por la capacidad de transmitir confort y elegancia a los espacios que crea.

Sus diseños son el resultado de un trabajo cuidado y aparentemente sencillo por el que muchos de sus productos han sido reconocidos como iconos del diseño industrial de nuestro país. Fue galardonado con la primera edición del Premio Nacional de Diseño, en 1987, Compasso d'Oro y Medalla de Oro al Mérito en las Bellas Artes 2016.

MMS table was part of the furniture of 'Casa Pairal' in Espolla, reformed by the architect José Antonio Coderch.



Casa Pairal, Espolla (1964)

ENG MMS is a light, small, stackable side table. Its shape and variety of potential compositions make it the ideal table for anywhere in the home, either at the bedside, as an auxiliary or coffee table in the living room or in other rooms.

An oak table finished in natural varnish, pleasant to the touch, which adds comfort to a home's interior design, blessed with the discretion and elegance typical of the work by Miguel Milá.

This piece of furniture has been re-released to underline the fact that the MMS 1963 table is one of our country's design classics.

ESP MMS es una mesa auxiliar ligera, pequeña y apilable, idónea, por su forma y por sus diversas composiciones posibles, para cualquier lugar de la casa, como mesita de noche, como auxiliar o para el café en el salón o en otros espacios.

Una mesa de madera de roble, barnizada al natural, de tacto agradable, que proporciona confort al interiorismo del hogar, con la discreción y la elegancia que caracterizan la obra de Miguel Milá.

Esta reedición quiere evidenciar que la mesa MMS 1963 de Miguel Milá forma parte de los clásicos del diseño de nuestro país.



Jujol 1920



61

Design by Josep Maria Jujol





Classic Collection

Josep Maria Jujol

Tarragona 1906 - Barcelona 1939

ENG Josep Maria Jujol (1879-1949) was a Catalan Modernista architect, draughtsman, designer and painter. A follower of Antoni Maria Gallissà and Lluís Domènech i Muntaner, he completed his architecture studies in 1906 and was also a professor at the Higher School of Architecture in Barcelona.

He collaborated with Antoni Gaudí, adding his own personality to the work. In fact, the architect Gaudí trusted him to design parts of his projects, giving him total creative freedom. As from 1904 he worked with Gaudí on the design of the main façade of the Casa Batlló, as well as the wrought iron railings and some of the plaster ceilings at the Casa Milà (popularly known as 'La Pedrera'), among other projects.

Jujol's work cannot be categorised. He participated in artistic movements such as Surrealism and Dadaism, as well as using abstract and informalist approaches. Some of Jujol's most notable architectural works are the Teatre Metropol (1908) in Tarragona; the reform of Casa Bofarull (1913 - 1931) in Els Pallaresos, Tarragona; the Torre de la Creu (1913 - 1916) in Sant Joan Despí, Barcelona and the Vistabella Church (1918) in La Secuita, Tarragona.

Of his collaboration with Gaudí, there is notably the Casa Batlló (1904 - 1906) in Barcelona, with its main façade and furniture; the Casa Milà (La Pedrera) (1906 - 1910) in Barcelona, its balcony railings and plaster ceilings; the Park Güell (1900 - 1914) in Barcelona, with the "trencadís" technique bench and ceilings in the hypostyle room as well as Mallorca Cathedral (1909 - 1910) in Palma de Mallorca, with paintings for the Gothic masonry for the choir and facings on the apse walls.

ESP Josep Maria Jujol (1879 - 1949) fue arquitecto, dibujante, diseñador y pintor modernista catalán. Discípulo de Antoni Maria Gallissà y Lluís Domènech i Montaner acaba sus estudios de arquitectura en el año 1906. Fue un catedrático en la Escuela Superior de Arquitectura de Barcelona.

Colaborador de Antoni Gaudí, participó en su obra con personalidad propia. El arquitecto Gaudí le confió la proyección de parte de sus obras con absoluta libertad creativa. A partir de 1904 colabora con Gaudí en el diseño de la fachada principal de la casa Batlló y en las barandas de forja y algunos de los techos de la Casa Milà (conocida popularmente como 'La Pedrera'), entre otras obras.

La obra de Jujol es inclasificable; Participó en movimientos artísticos como el surrealismo o el dadaísmo y en la utilización de de lenguajes abstractos o informalistas. De las obras arquitectónicas de Jujol destacamos el Teatro Metropol (1908), Tarragona; la reforma de la Casa Bofarull (1913-1931), Els Pallaresos, Tarragona; la Torre de la Creu (1913-1916), Sant Joan Despí, Barcelona o la iglesia de Vistabella (1918), La Secuita, Tarragona.

De la colaboración con Gaudí destacamos la Casa Batlló (1904-1906), Barcelona, la fachada principal y mobiliario; la Casa Milà (La Pedrera) (1906-1910), Barcelona, las barandas de los balcones y los techos; el Park Güell (1900-1904), Barcelona, el banco de "trencadís" y los techos de la sala hipóstila o la Catedral de Mallorca (1909-1910), Palma de Mallorca, las pinturas de la sillería gótica para el coro y el revestimiento de los muros del ábside.

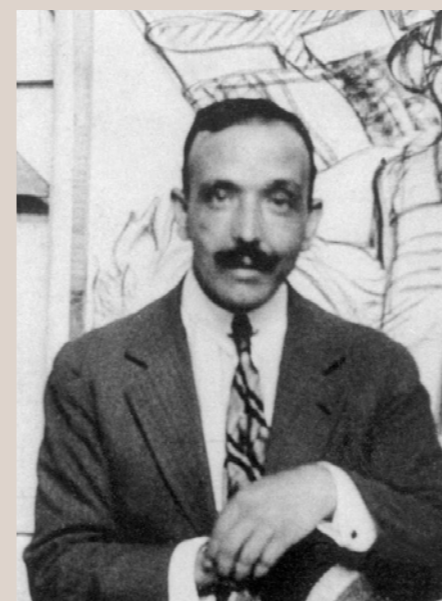

The Jujol table is a reproduction of the one exhibited permanently at the MNAC (National Art Museum of Catalonia).



Permanent exhibition in MNAC (National Art Museum of Catalonia)

ENG The Jujol table was designed between 1920 and 1927 by the architect Josep Maria Jujol. This is a reproduction of the table exhibited at the MNAC (National Art Museum of Catalonia).

It comes from the house where JM Jujol lived, on the Rambla de Catalunya in Barcelona and, given how it was constructed, we can conclude that it's a prototype, a unique model which we have reproduced and now forms part of the Mobles 114 Classics catalogue.

Jujol 1920 is a side table that warrants being admired as a work of art; a practical, versatile table that adds dignity, gravity and elegance to any interior design.

Made from oak, the two oval tops have been placed at different heights, giving the table a unique character and personality. Far removed from the Catalan Modernista style, Jujol went beyond fashion and designed a table that doesn't look out of place in the 21st century.

ESP La mesa Jujol fue diseñada entre los años 1920 y 1927 por el arquitecto Josep Maria Jujol. Es una reedición de la mesa expuesta en el MNAC (Museo Nacional de Arte de Cataluña).

Proviene del domicilio donde vivió Jujol en la Rambla de Cataluña de Barcelona y, por la manera que está construida, podríamos decir que se trata de un prototipo, un ejemplar único que reeditamos y que forma parte del catálogo de Classic de Mobles 114.

Jujol 1920 es una mesa auxiliar que invita a admirarla como una obra de arte. Una mesa práctica y versátil que acompaña la decoración de espacios de interior aportando nobleza, obriedad y elegancia.

Construida con madera de roble, los dos sobres ovalados dispuesta en dos niveles le otorgan un carácter y personalidad únicos. Lejos del estilo modernista, Jujol traspasa estilos y diseña una mesa que en pleno siglo XXI tiene una vigencia indiscutible.



Oxi bistrot



65

Design by Massana - Tremoleda



HPL Top finishes available in white, black, oak or walnut.
Check technical information (pag. 143)



Pey central

67

Design by Massana - Tremoleda



PEY table system

69



Design by Massana - Tremoleda

**A place to work. A place to
converse and think. A place
to build and share ideas.**

Multiple options to design your table

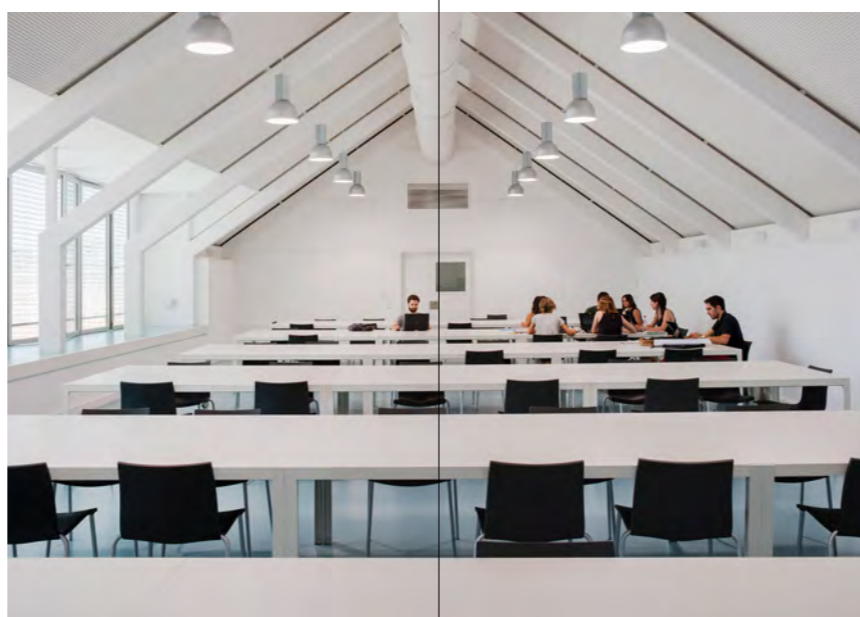

**Home
Meeting
Office
Storage
Education
Libraries
Outdoor**



Few legs on big sizes
Largest table with four legs:
280 X 180cm.

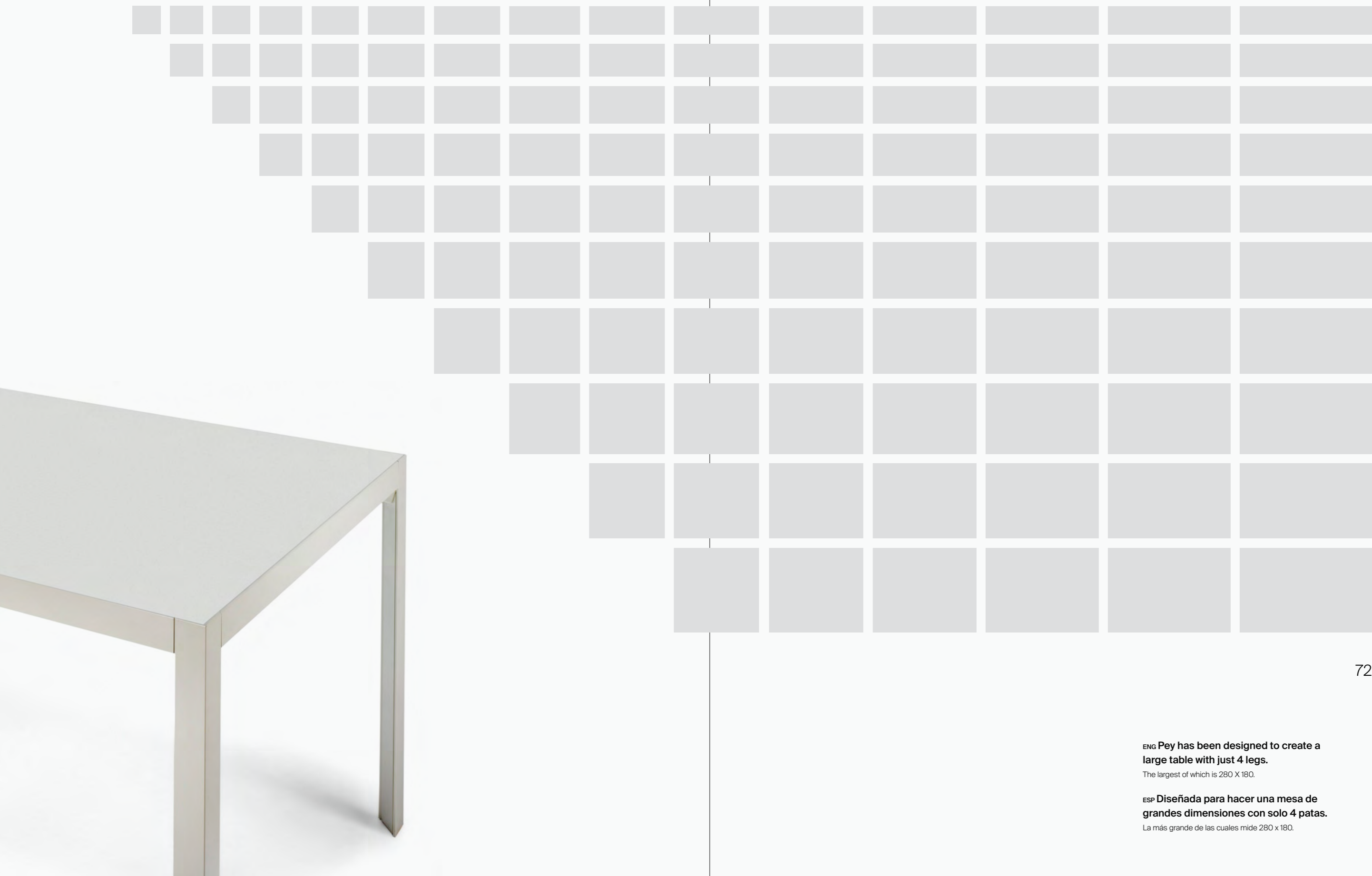

ENG **Pey has been designed to create a large table with just 4 legs.**
The largest of which is 280 X 180.

ESP **Diseñada para hacer una mesa de grandes dimensiones con solo 4 patas.**
La más grande de las cuales mide 280 x 180.



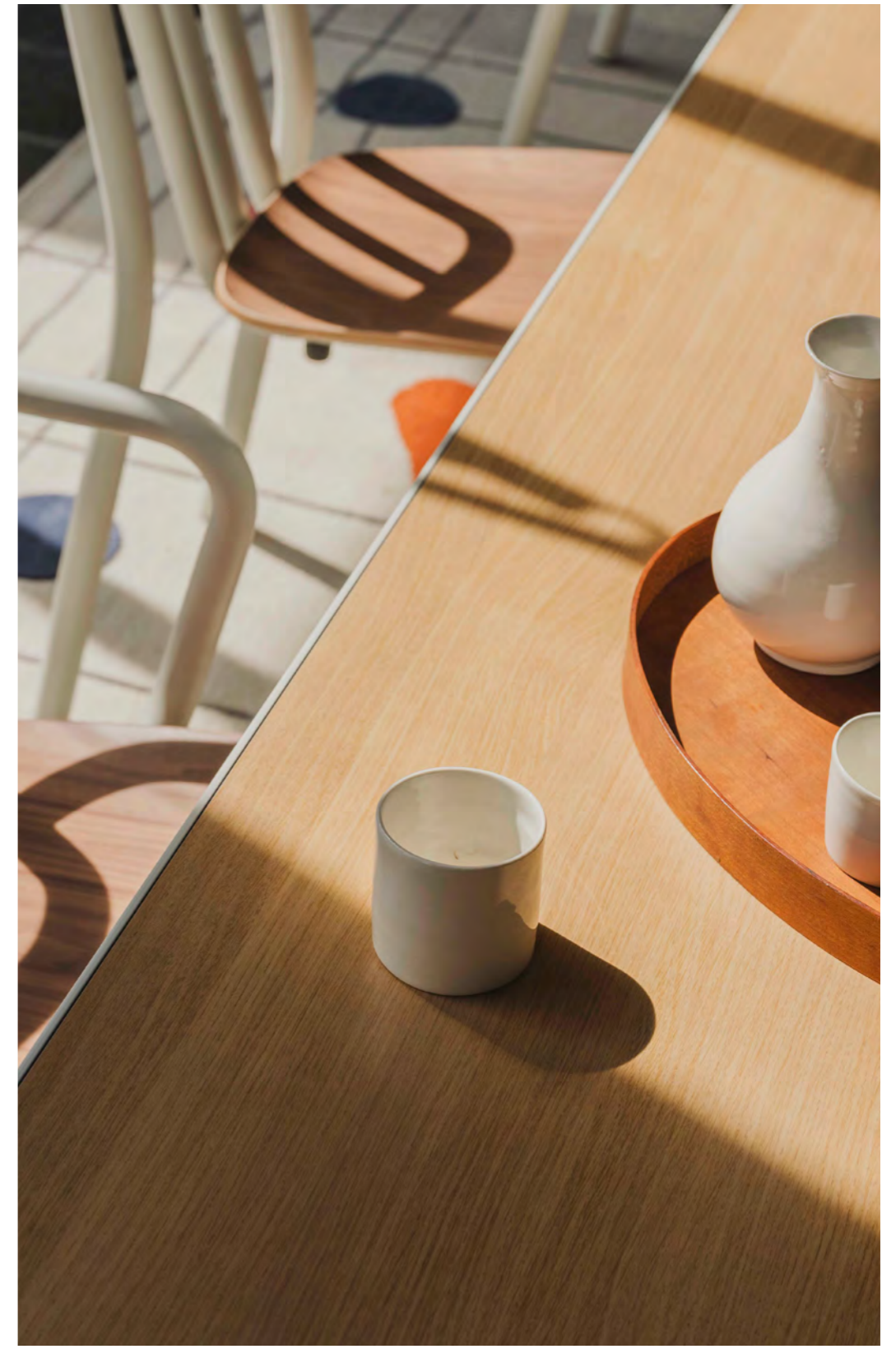









Choose the best table composition for your space with PEY table.



Multiple electrification options for variety of locations with high demands regarding services.



HPL top



Single Top

Finishes



Oak Walnut



RAL 9002 RAL 9004

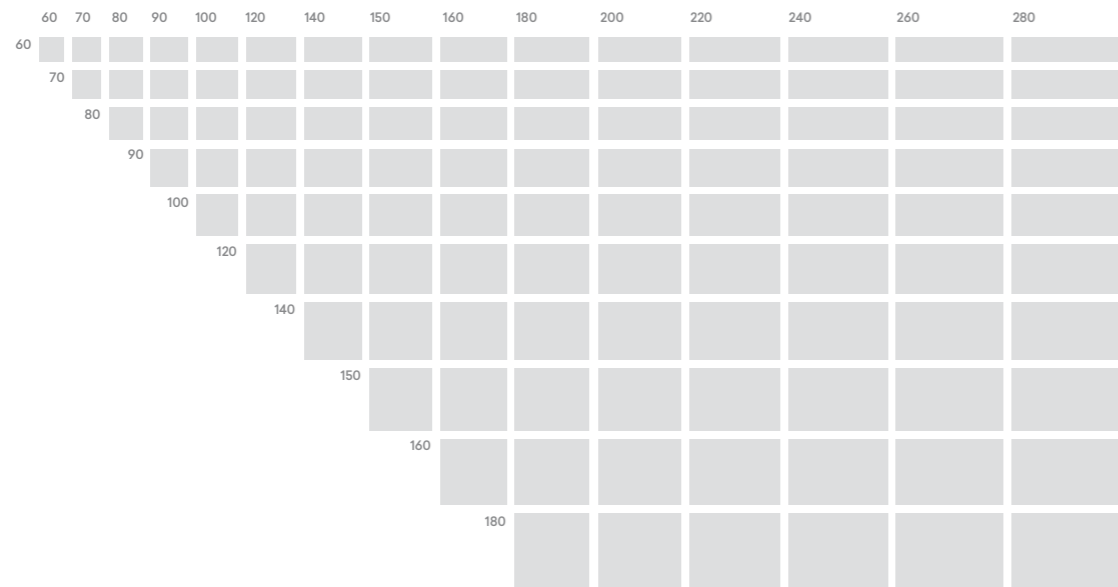

Electrification

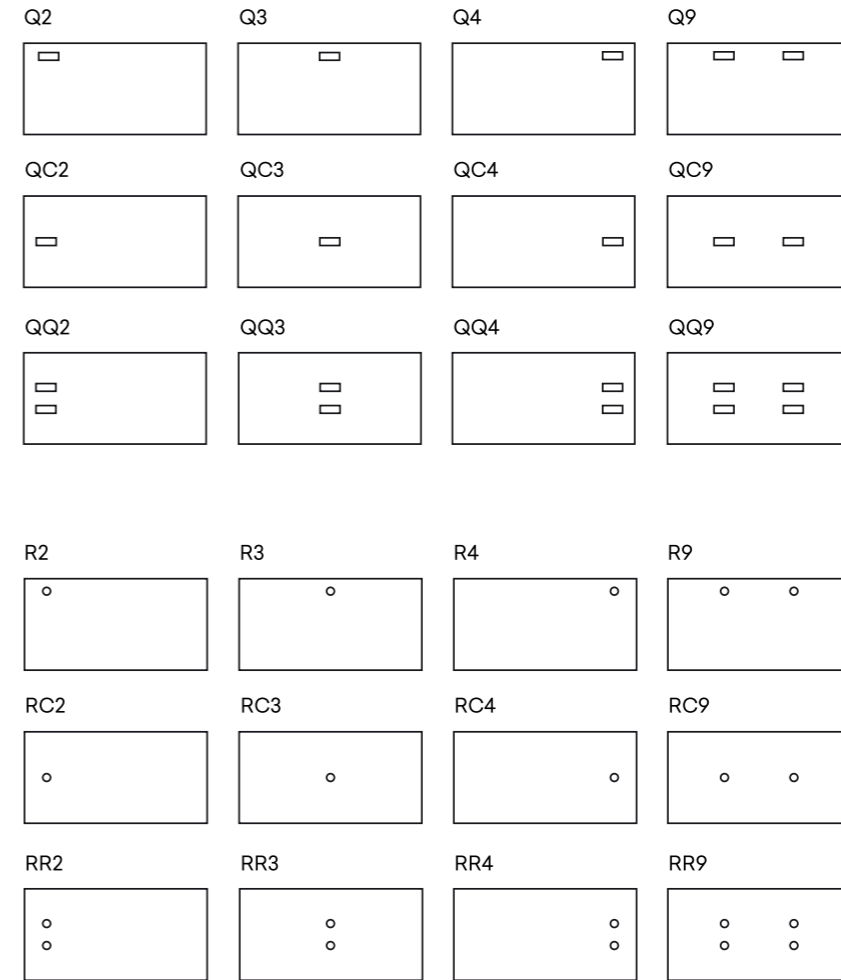

Structure

Pey with 4 legs

76 and 90 cms



Finishes



RAL 9002 RAL 9004

Accessories for desk leg

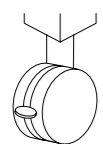

Casters with brakes

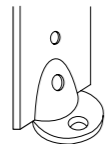

Subjection to the floor

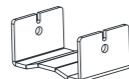
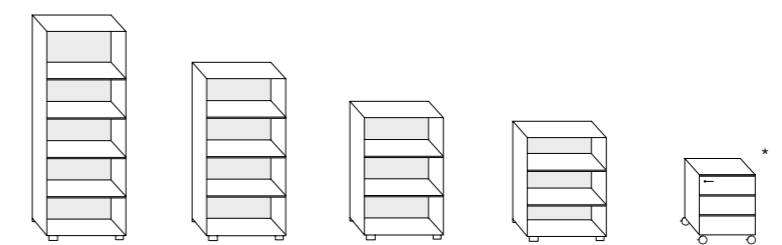
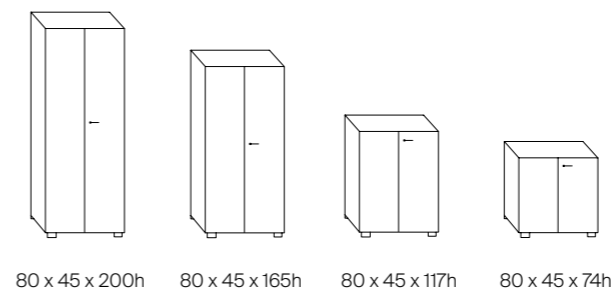

Table Union

Storage



Finishes

Cabinets



RAL 9010

* Pedestal with drawers



RAL 9002 RAL 9004

Electrification

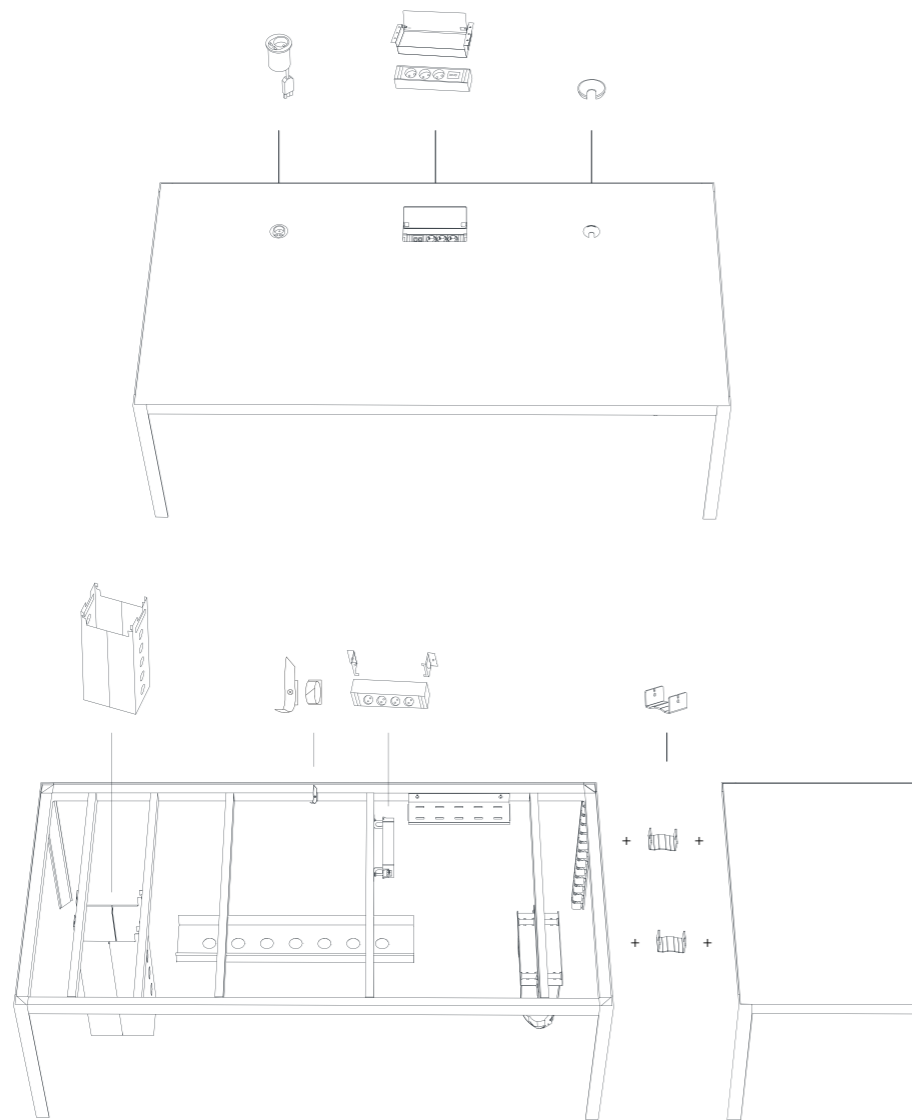

Normatives

Table

UNE-EN 527-1:2001
Dimensions

UNE-EN 527-2:2003
Mechanical safety

UNE-EN 527-3:2003
Mechanical strenght and
stability of the structure

EN-61340 (parts 2-1, 2-3, and 5/1)
Protection against electrostatic
phenomena (lipoatrophy preven-
tion)

UNE EN 15372:2008
Strength, durability and safety
for non-domestic tables.

Top

High pressure laminated
(HPL)

EN 432-2 item 21
High resistance to impacts

EN 438-2 item 25
High superficial resistance

EN ISO 178
Resistance to flexion, level 6-8

EN 438-2 item 27
lightfastness

EN 13501-1
Euroclass D-s2, d0
fire resistance
(M1 upon request).

Structure

Extruded aluminium

SGS DIN 10204
Metallic products certificate

1999/45/EC Paint:
Directive (dangerous preparations)

67/548/EEC
Directive (dangerous substances
forthe environment).





COMPLEMENTS

Forc



84

Design by Lagranja design





Hulot



86

Design by Joan Gaspar

Joan Gaspar's passion for design and extensive knowledge of production techniques form an essential part of his approach.

ENG This design with its organic forms was born out of a combination between observations from nature and industrial technology, creating an elegant, simple but unique coat stand. Eminently practical and unobtrusive, the Hulot coat stand is designed to fulfil its function to perfection.

ESP De la combinación de la observación de la naturaleza y la tecnología industrial nace un diseño de carácter formal orgánico que nos propone un perchero de pie, noble, sencillo y único. El perchero Hulot está pensado para cumplir su función de manera práctica y discreta.



Taiga



88

Design by Antoni Arola



ENG Taiga coat stand takes its inspiration from the organic shapes of Siberia's conifer forest shown in the film Dersu Uzala by the Japanese film director Akira Kurosawa, where the forest is also called Taiga. The collection also includes a version with an incorporated umbrella stand.

ESP El perchero de pie Taiga está inspirado en las formas orgánicas de los bosques de coníferas de Siberia que aparecen en la película Derzu Uzala, del cineasta japonés Akira Kurosawa, también llama al bosque con el nombre de Taiga. Completan la colección la versión con paraguero incorporado y el paraguero individual.



**Color finishes available
in black or white**
Check technical information (pag. 143)



Mirac

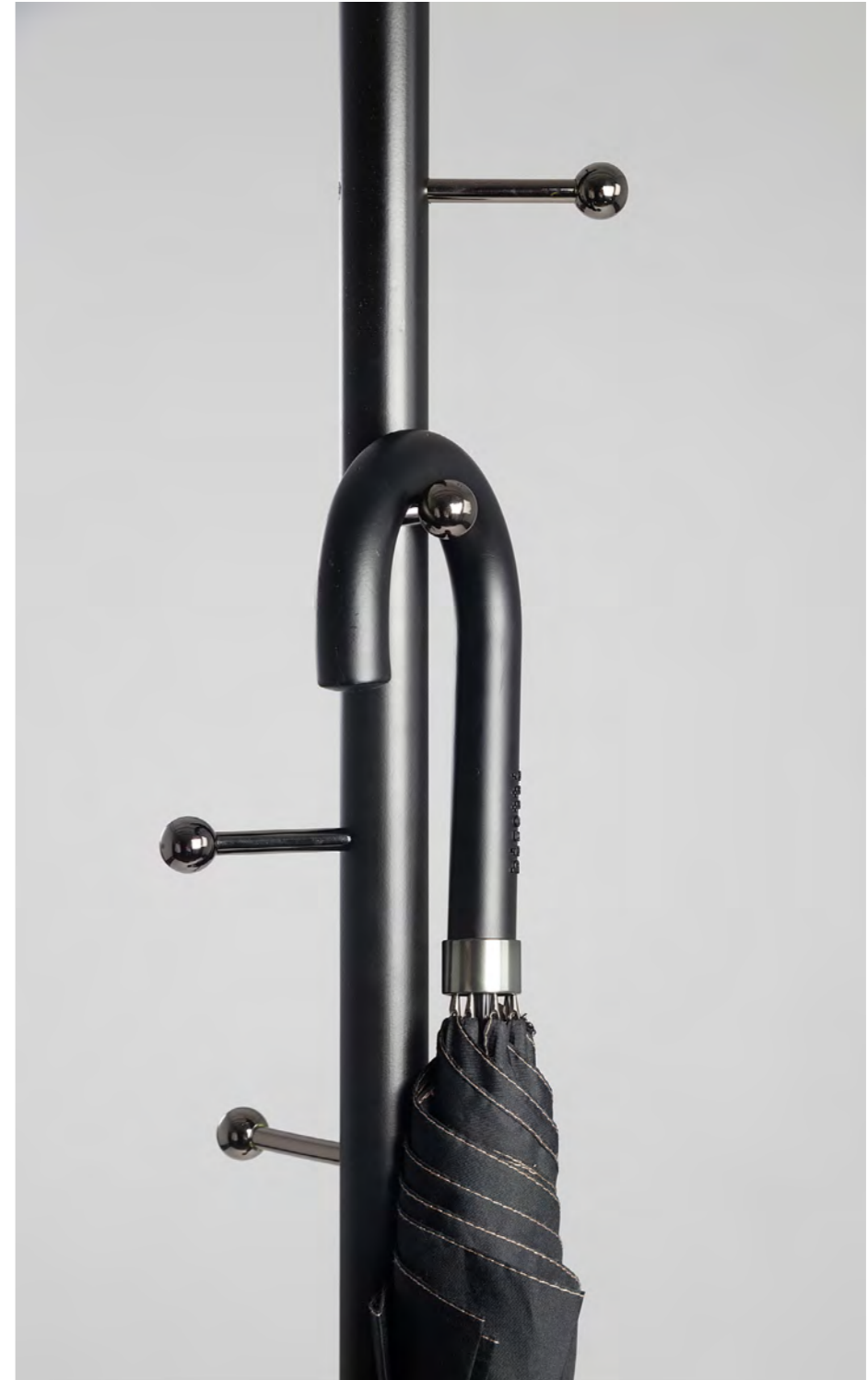

90

Design by Massana - Tremoleda





Ona



92

Design by Montse Padrós - Carles Riart



ENG The Ona coat rack was designed by Montse Padrós and Carles Riart to furnish Pedreño's house in Barcelona.

ESP Montse Padrós y Carles Riart crearon el perchero Ona para amueblar la casa Pedreño de Vallvidrera, Barcelona.



Bambú



94

Design by Massana - Tremoleda



Natural elegance

ENG The separation of the pegs along the aluminium tube is reminiscent of circuits separating the elastic and static segments of bamboo canes. The natural elegance of the plant creates a dialogue with this unpretentious design that conveys naturalness.

Elegancia natural

ESP La separación de las perchas en el tubo de aluminio nos recuerda a los círculos que separan los segmentos de los tallos elásticos y firmes del bambú. La elegancia natural de la planta dialoga con un diseño sin pretensiones que transmite naturalidad.



Riga



97

Design by Massana - Tremoleda



ENG A formal design that conceals an ingenious. A combination of technology and design resulting from studying the material and optimising production resources, giving the Riga bin the best features and attributes with the minimal materials possible: a sustainable proposal.

ESP Un diseño formal que esconde el ingenio de los pliegues de una chapa; una combinación de tecnología y diseño, resultado del estudio del material y la optimización de los recursos productivos, que hacen de la papelera Riga un producto que ofrece las mejores prestaciones y atributos con el mínimo material posible: una propuesta sostenible.



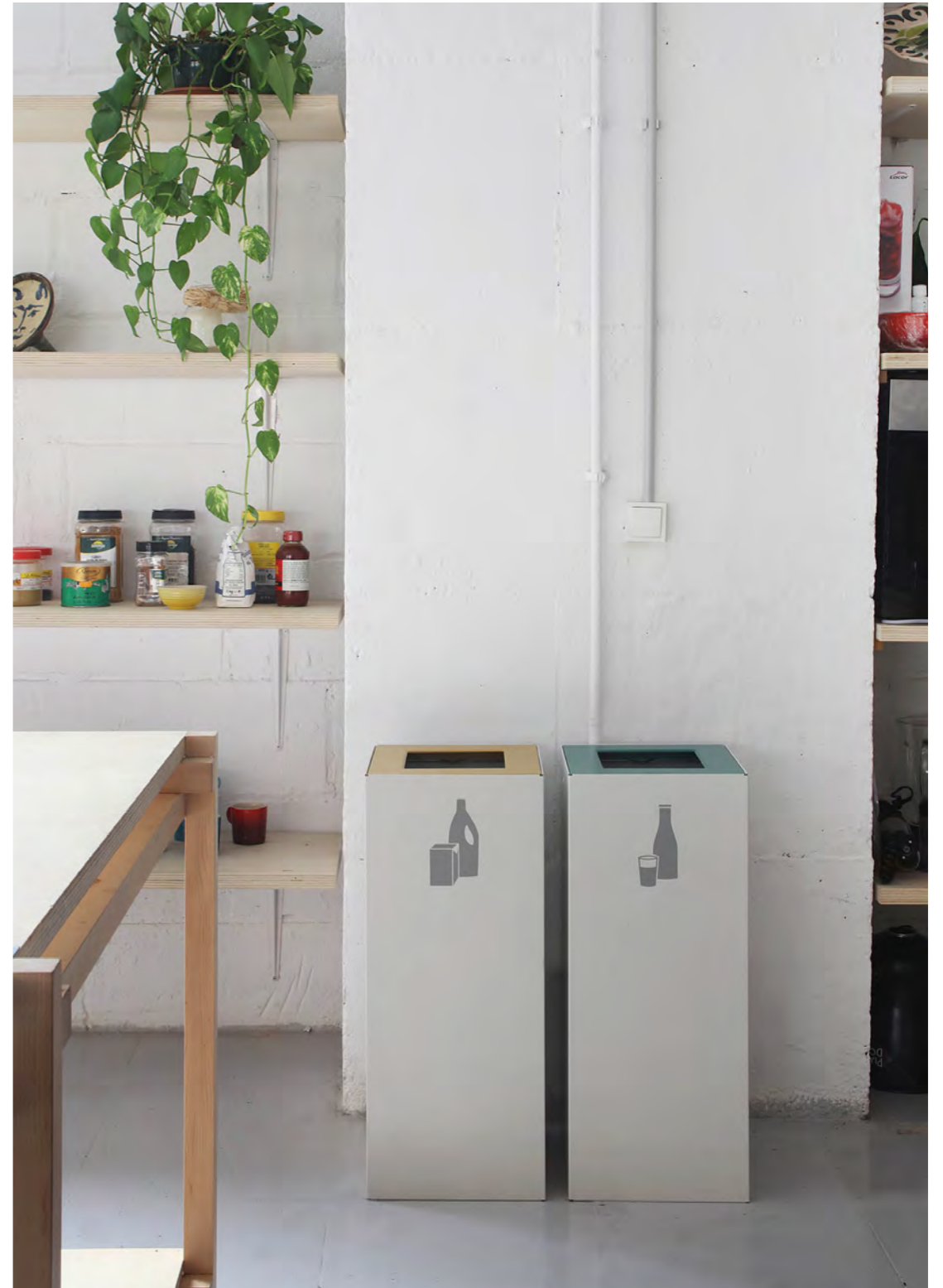

Tombal



100

Design by Miguel Milá



ENG Tombal is an elegant multi-use product; a practical umbrella stand or an ashtray. Designed in 1990 by Miguel Milá and produced in 2017 by Mobles114. It's a good example that good designs resist the ravages of time. Tombal can be an umbrella stand or an ashtray depending on which way up you stand it. It resists the humidity, the vase is easy to empty and thanks to the excellent properties of the ceramic it is very durable and easy to clean.

ESP Tombal es un paraguero o cenicero elegante y práctico. Diseñado en 1990 por Miguel Milá y reeditado el año 2017 por Mobles 114 es un rotundo ejemplo de que el buen diseño resiste a la perfección el paso del tiempo. Tombal puede ser un paraguero o un cenicero por su estructura reversible. Es resistente a la humedad, el recipiente permite vaciar el agua con facilidad y gracias a las excelentes propiedades del gres es muy duradero y fácilmente lavable.





Platea

102

Design by Massana - Tremoleda



Fil 1991



104

Design by Álvaro Siza



Classic Collection

Álvaro Siza

Matosinhos, 1933

ENG Álvaro Siza was born in Matosinhos, Portugal. An internationally renowned architect, he created his first designs in Portugal where he earned a reputation for their elegant, respectful integration within the architecture and landscape. The Marés swimming pools at Leça de Palmeira and the Da Boa Nova restaurant are a good example of this.

Siza's architecture is guileless, minimal and efficient, conveying a sense of withdrawal or inner contemplation; architecture that has been constructed in many different countries in the world but always preserving this capacity to provoke contemplation.

He's won many different architecture prizes including the Mies Van der Rohe Award in 1988 and the Pritzker Prize of 1992.

ESP Álvaro Siza nace en Matosinhos, Portugal. Arquitecto de reconocido prestigio internacional, proyecta sus primeras obras en su país natal, donde ya destaca por su elegante y respetuosa integración de arquitectura y paisaje. Ejemplo de ellas son las piscinas das Marés en Leça de Palmeira o el restaurante-casa de té Boa Nova.

Siza proyecta una arquitectura sin artificios, mínima y eficiente, que transmite una sensación de recogimiento; una arquitectura que ha construido en muchos países del mundo, conservando siempre la capacidad de provocar esta emoción.

Ha sido distinguido con multitud de premios de arquitectura, entre los que destacan el Mies Van der Rohe en 1988 y el Pritzker en 1992.



A light inspired by the evolution of brass or bronze oil lamps that included a shade to avoid dazzle.

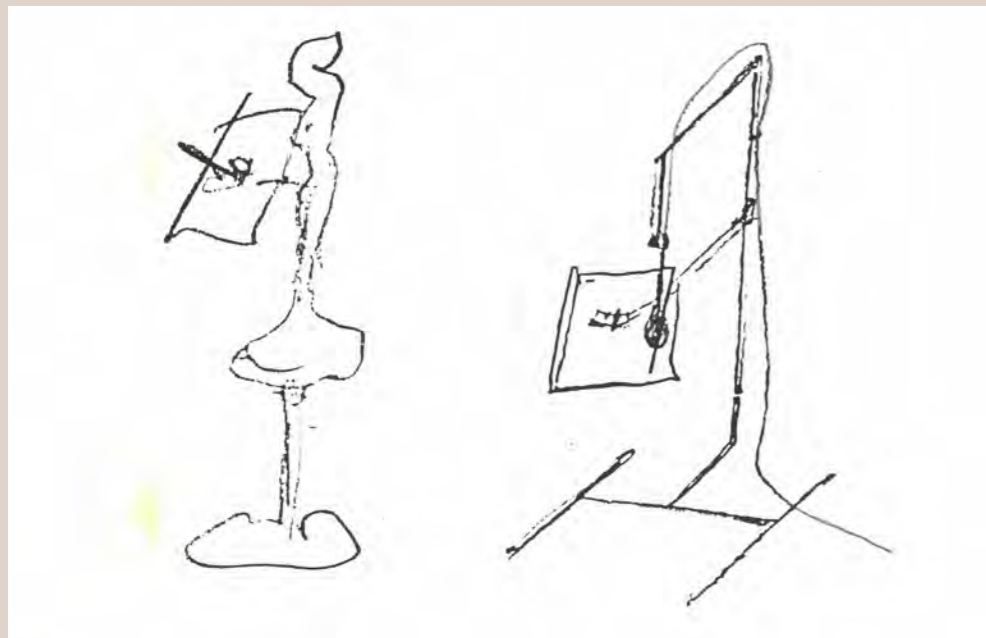

First sketches by Álvaro Siza

ENG Fil is a table lamp designed in 1991 by the architect Alvaro Siza Vieira which artlessly reveals the essence of an electric light: a support, the electric wire with the lightbulb and a shade.

A light that forgoes ornaments, inspired by the evolution of brass or bronze oil lamps that included a shade to avoid dazzle.

Made in stainless steel, the Fil lamp by Siza Vieira forms part of the Classics catalogue of Mobles 114 thanks to its contemporary roots and in homage to one of today's great architects.

ESP Fil es una lámpara diseñada en 1991 por el arquitecto Álvaro Siza Vieira que muestra sin artificios lo que constituye la esencia de una lámpara eléctrica: un soporte, el cable eléctrico con la bombilla y una pantalla. Una lámpara que rescinde de ornamentos, inspirada en la evolución de los candiles de latón o de bronce que incorporaban una pantalla para evitar deslumbramientos.

Fabricada en acero inoxidable, la lámpara Fil de Siza Vieira forma parte del catálogo Clásicos de Mobles 114 por su radicalidad contemporánea y en homenaje a uno de los grandes arquitectos actuales.



Copenhaguen 1966



107

Design by André Ricard



Classic Collection

André Ricard

Barcelona 1929

ENG A pioneer of Spanish industrial design, André Ricard was Chairman of ADI-FAD, Founding Chairman of ADP and a member of the Faculty of the Art Centre (Switzerland), among other positions. An internationally renowned author, he has designed containers, utensils, lighting, domestic appliances and items of furniture that have ended up forming part of our everyday lives at home. Among his most well-known designs are the Copenhagen ashtray, released by Mobles 114, and the Olympic torch for the Barcelona 1992 Games.

Taking a logical, analytical approach he “harmoniously integrates the most beautiful form with the demands of the function”, applying a style of design that’s classic because it’s timeless and never becomes outmoded.

André Ricard has been recognised with Spain’s National Design Award, the Sant Jordi Cross from the Catalan government, the Olympic Order of the International Olympic Committee and the Gold Medal for Artistic Merit of the city of Barcelona, and has also been made a Chevalier des Arts et des Lettres and Chevalier de la Légion d’Honneur of France.

ESP Pionero del diseño industrial español, André Ricard ha sido presidente de la asociación ADI-FAD, presidente fundador de la ADP y profesor en el Art Centre Europe (Suiza). Autor de prestigio internacional, ha diseñado envases, utensilios domésticos, aparatos de iluminación, electrodomésticos y piezas de mobiliario que han sido asimilados como parte del paisaje doméstico cotidiano. Entre sus obras más conocidas destacan el diseño del cenicero Copenhagen, editado por Mobles 114, o la Antorcha Olímpica para los Juegos Olímpicos de Barcelona '92.

Aplicando el método del análisis lógico consigue “la integración armoniosa de la forma más bella y de las exigencias de la función” en un estilo de diseño clásico por lo perdurable y que no deja de ser actual.

André Ricard ha sido reconocido con el Premio Nacional de Diseño, la Creu de Sant Jordi de la Generalitat de Catalunya, la Orden Olímpica del Comité Olímpico Internacional y la Medalla de Oro al Mérito Artístico de la Ciudad de Barcelona. Asimismo, es Chevalier des Arts et des Lettres y Chevalier de la Légion d’Honneur de Francia.

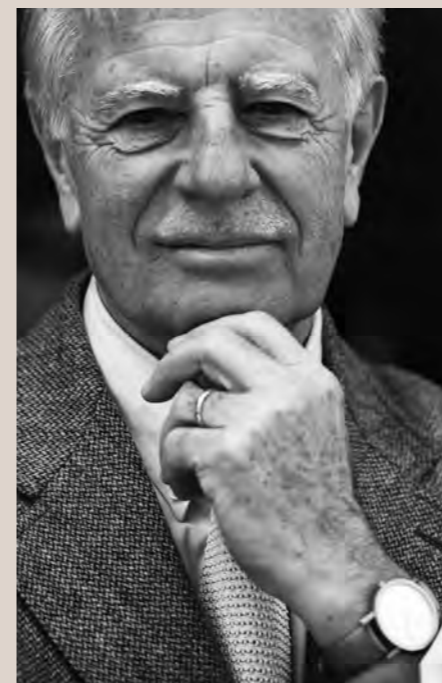

Copenhaguen ashtray is the result of a geometric design that uses the simple repetition of a cylinder.

ENG With sober lines and minimalist design, free from adornments, this set of melamine ashtrays created by André Ricard in 1966 has amply demonstrated the beauty of useful things.

Made in a single block, this ashtray is the result of a geometric design that uses the simple repetition of a cylinder.

A recipient made up of an open cylinder with another, smaller cylinder inside to support or extinguish cigarettes; the shape of the groove in the outer wall matches the rest of the ashtray and is perfectly designed to hold a cigarette.

This is a hardwearing, stackable ashtray that fulfils its function with the utmost effectiveness. This design classic is in line with the goal of Mobles 114 which, for more than 20 years, has remained in the market to preserve our country's heritage in terms of both culture and design. The Copenhagen ashtray won the ADI_FAD Delta Silver Prize 1966.

ESP De líneas sobrias y con un diseño mínimo y exento de ornamentos, este juego de ceniceros de melamina creados por el diseñador industrial André Ricard en 1966 ha demostrado sobradamente la belleza de las cosas útiles. Fabricado de una sola pieza, este cenicero es el resultado de diseñar con la sencilla repetición de la geometría del cilindro. Un recipiente conformado por un cilindro abierto del que emerge otro cilindro interior más pequeño en el que apoyar o apagar el cigarrillo; la boquilla de la pared exterior, a juego con el resto del cenicero, es idónea para alojar el cigarrillo.

Es un cenicero apilable y resistente que cumple su función con la máxima eficacia. Este clásico del diseño responde a la voluntad de Mobles 114, que desde hace más de dos décadas lo ha mantenido en el mercado a fin de preservar el patrimonio cultural y del diseño de nuestro país. El cenicero Copenhagen fue galardonado con el Delta de Plata ADI-FAD 1966 y Delta de Oro 25 años AdiFad 1985.





Tong 1964



110

Design by André Ricard



Classic Collection

André Ricard designed these tongs in 1964 for ice cubes back in the day when plastic was a relatively new material.



First model of the ice tong by André Ricard (1964)

ENG These ice tongs, relaunched in 2018, are an updated version of the ones designed by André Ricard in 1964.

Ricard has slightly altered the width of the tongs, as well as using a new type of plastic to improve their performance. The tongs are a classic design created in Barcelona in the 1960s and form part of the Mobles 114 Classic Collection. A devotee of simplicity and functionalism, André Ricard designed these tongs for ice cubes back in the day when plastic was a relatively new material. This gave the designer the chance to rethink an object that had always been produced in the same way. Most tongs were made of steel or wood, with a pivot or spring to ensure they returned to their original position.

Ricard's design makes use of the shape of the tongs themselves as their mechanism. His masterful solution takes advantage of the tong's leverage and the flexibility inherent in plastic. The designer has thought about the hands that are going to hold the product and the product that's going to hold onto the ice cubes. These tongs are the perfect extension.

ESP La pinza para hielo reeditada en 2018 es una versión actualizada de la que diseñó André Ricard en 1964.

Ricard nos propone una ligera modificación en el ancho de la pinza y la utilización de nuevos materiales plásticos que permiten una mejora en el uso. La pinza es un clásico del diseño hecho en Barcelona en los años 60 y forma parte de la Colección de Classic de Mobles 114. Fiel a la simplicidad y al funcionalismo, André Ricard diseñó una pinza para cubitos de hielo en una época en la que el plástico era un material relativamente nuevo. Para el diseñador fue una oportunidad para plantear de nuevo un producto que había sido fabricado siempre de la misma manera. Las pinzas eran en su mayoría de acero o madera y la función se ejercía por el movimiento a partir de un eje, o del retorno a partir de un efecto muelle.

El diseño de Ricard resuelve la función de la pinza a partir de la propia forma. Aprovecha la combinación de la palanca y la propia flexibilidad del plástico con una solución magistral.



Frac



112

Design by Mobles 114



Circus



113

Design by Mobles 114

Clac



114



TRIA SHELVING



TRIA shelving system

116

Design by Massana - Tremoleda

Fits to anyone, anywhere.

Designed in 1978, now a modern day icon.



- Living room
- Bathroom
- Kitchen
- Books
- Dressing room
- Kids & Teens
- Office



Auxiliar shelf







How it works.
 Discover the different possibilities
 of Tria shelving system.

Depth 24cm

Wall system

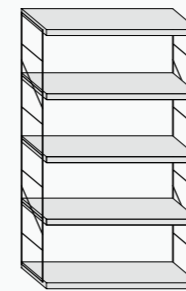

Floor system
 (wall mounted)

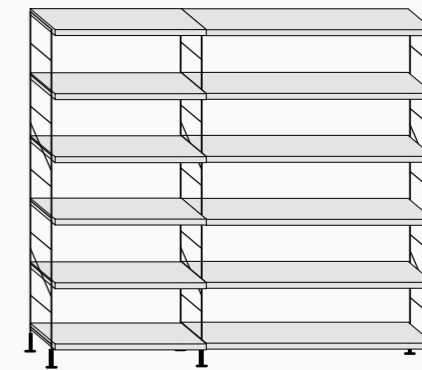

Depth 36cm

Wall system

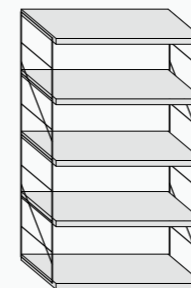

Floor system
 (wall mounted)

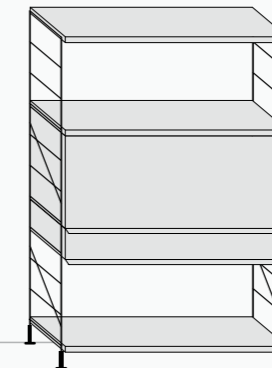

Free-standing

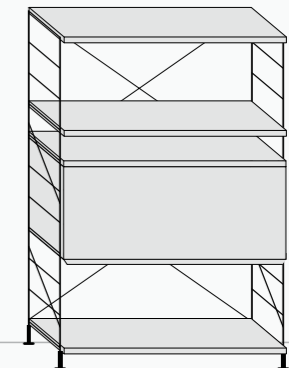



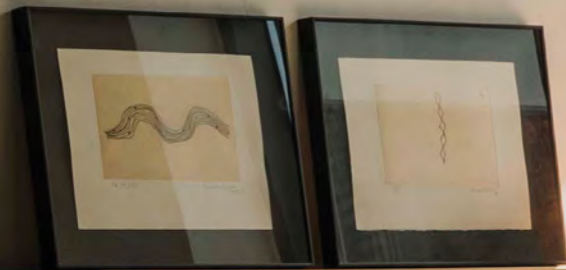





Plan your TRIA in
just 3 steps

Online configurator

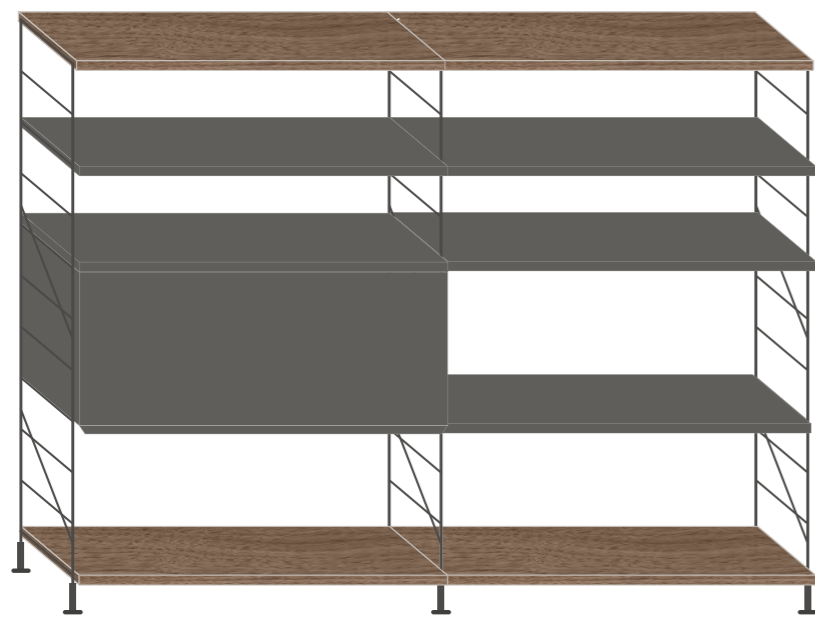

tria.mobles114.com













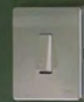

Free standing version

Versión autoportante

ENG Tria free standing version doesn't need to be attached to the wall, so you don't need to make any holes, can place the shelves in front of a mirror-glass or divide up a large space.

ESP La versión autoportante permite que no haga falta fijar la estantería a la pared, ya sea para evitar hacer agujeros, para poder ponerla delante de un cristal o para separar espacios.



How many cross-bars do you need to make TRIA free standing?

H73 cm

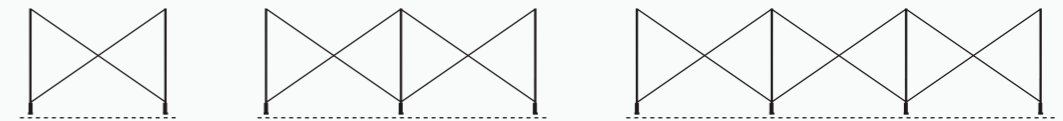

H135 cm

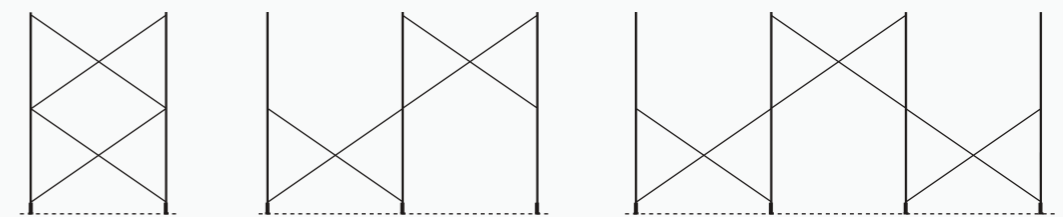

H198 cm

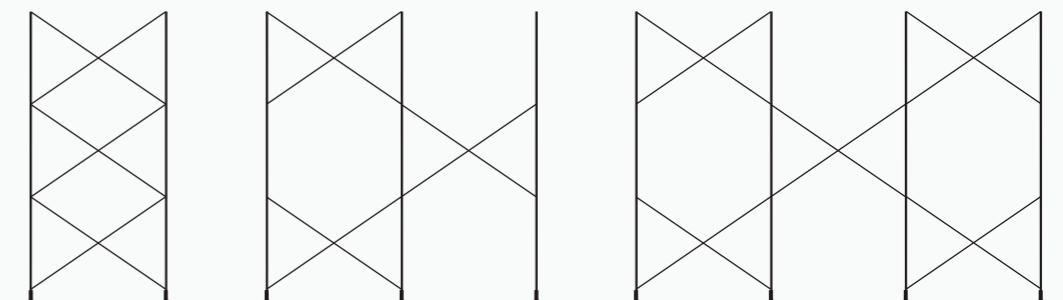



Magnet

Tria Pack floor & wall mounted



TRIA wall system

All measures in cm

* Not suitable for plasterboard or non-supporting walls.

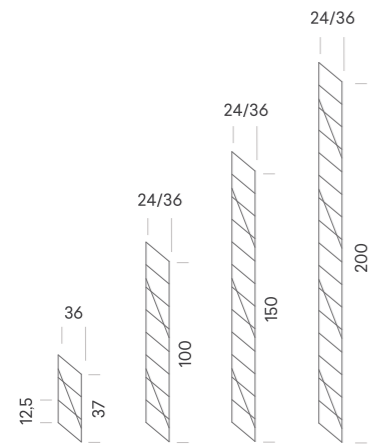

Finishes

Metal structure

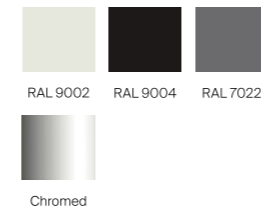

TRIA floor system (wall mounted)

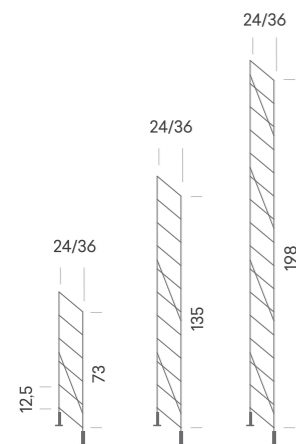

Finishes

Metal structure



TRIA free standing

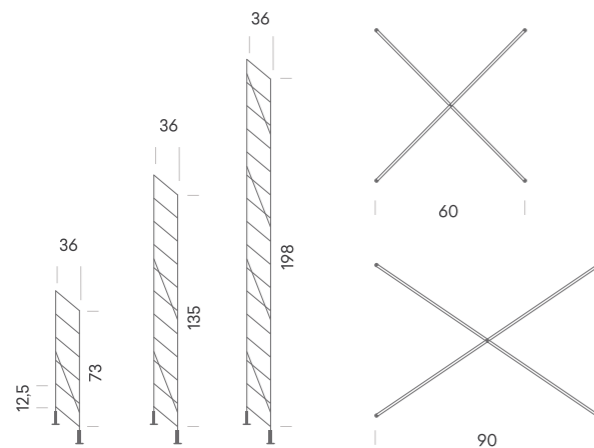

Finishes

Metal structure

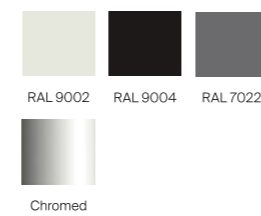

Free standing structure

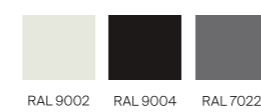

How many free standing structure do you need?

All measures in cm

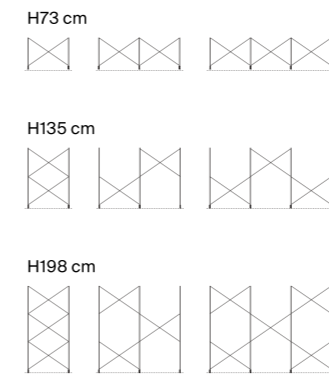

TRIA pack wall system

* Not suitable for plasterboard or non-supporting walls.

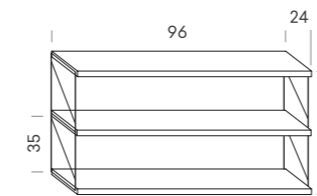

Finishes



TRIA pack floor system (wall mounted)

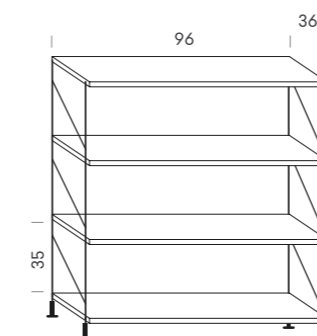

Finishes



TRIA shelves

All measures in cm

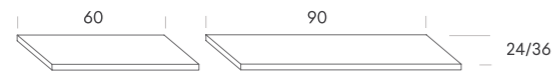

Finishes

Metal shelves



RAL 9002 RAL 9004 RAL 7022



RAL 2001 RAL 1024 RAL 6000

Wooden shelves



Oak Walnut Cedar

TRIA drawer

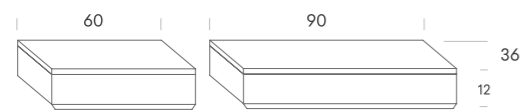

Finishes

Metal



RAL 9002 RAL 9004 RAL 7022



RAL 2001 RAL 1024 RAL 6000

TRIA inclined shelf

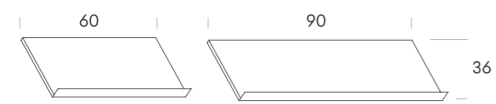

Finishes

Metal shelves



RAL 9002 RAL 9004 RAL 7022

TRIA grid shelf



Finishes



RAL 9002 RAL 9004 RAL 7022



Chromed

TRIA cabinet

All measures in cm

* Wooden cabinets with white, black or grey structure.

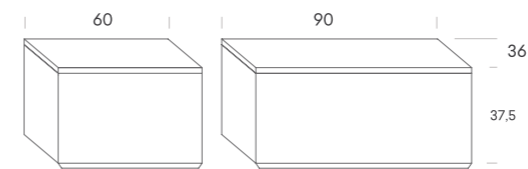

Finishes

Metal



RAL 9002 RAL 9004 RAL 7022



RAL 2001 RAL 1024 RAL 6000

Wooden



Oak Oak Oak



Walnut Walnut Walnut

TRIA cabinet top

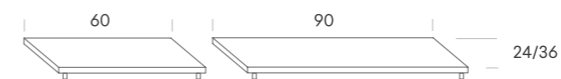

Finishes

Metal shelves



RAL 9002 RAL 9004 RAL 7022



RAL 2001 RAL 1024 RAL 6000

Wooden



Oak Walnut Cedar

TRIA clothes hanger bar



Finishes



Chromed

TRIA desk

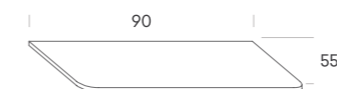

Finishes



RAL 9002 RAL 9004 RAL 7022

TRIA auxiliar shelf

All measures in cm

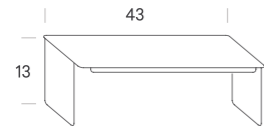

Finishes

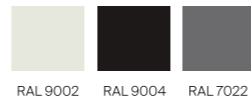

TRIA book - holder

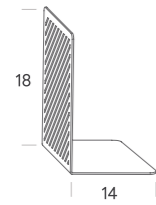

Finishes



TRIA hook

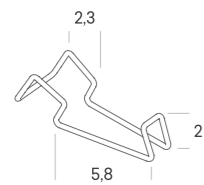

Finishes

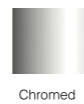

TRIA skin board accessory

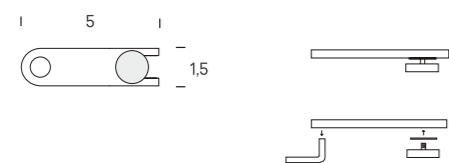

Finishes

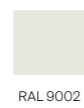

Clac magnet

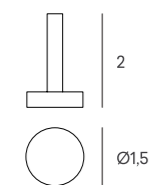

Finishes

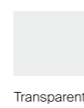

Technical information

Seats

Gràcia Design by Massana - Tremoleda

Gràcia metal 

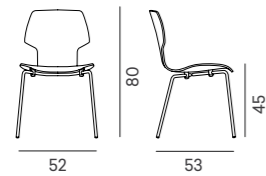

Gràcia metal textil cushion

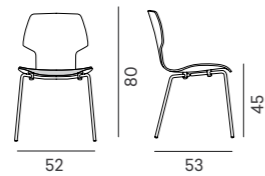

Gràcia metal textil front

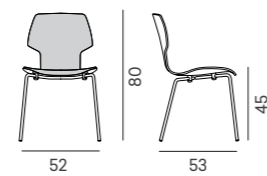

Finishes

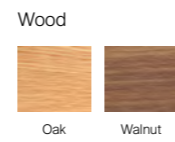

Metal structure

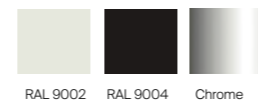

Textil



Optional:
Polypropylene cushion

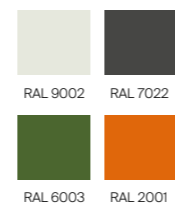

Gràcia wood

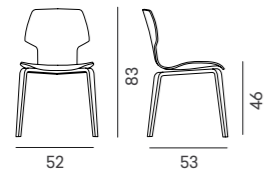

Gràcia wood textil cushion

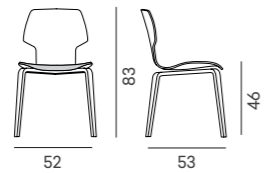

Gràcia wood textil front

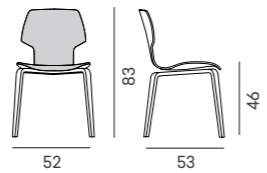

Gràcia with writing table 

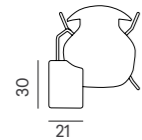
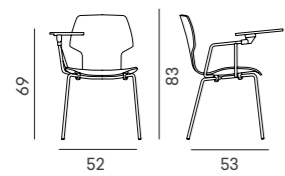

Rambla Design by Martín Azúa



Finishes

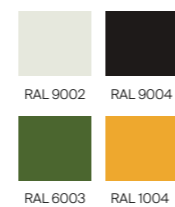

Tube Design by Eugeni Quitllet

Tube 

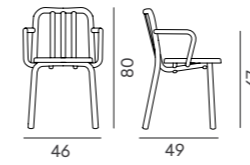

Tube wood

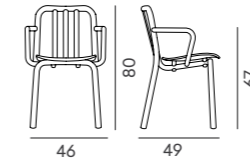

Finishes

Wood

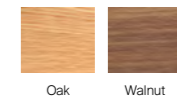

Structure

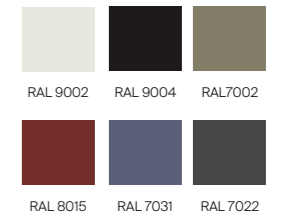

Green eco Design by Javier Mariscal

Green eco metal 

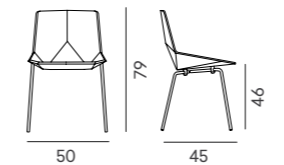

Green eco wood

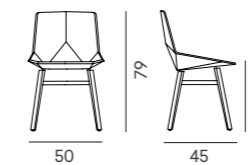

Finishes

Structure



Seat

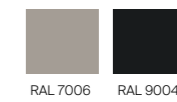

Green colors Design by Javier Mariscal

Green colors metal 

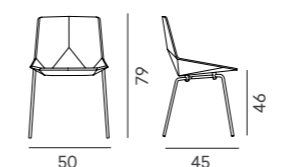

Green colors wood

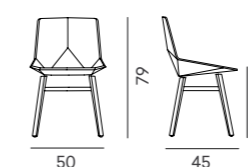

Finishes

Structure

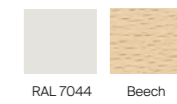

Seat

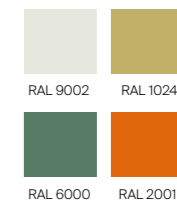

* Check our fabric catalogue for more information (pag.146)

Gràcia stool Design by Massana - Tremoleda

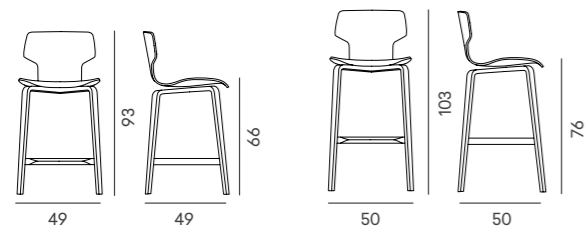

Finishes

Wood

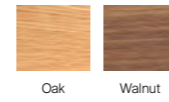

Optional:

Polypropylene cushion

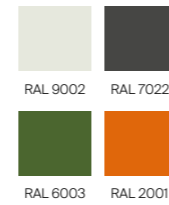

Nuta Colors Design by Lluís Pau

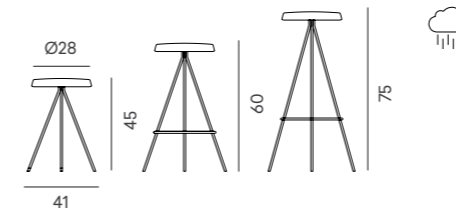

Finishes

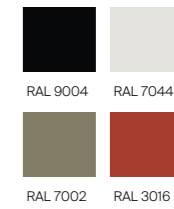

Tube stool Design by Eugeni Quitllet

Tube

Tube wood

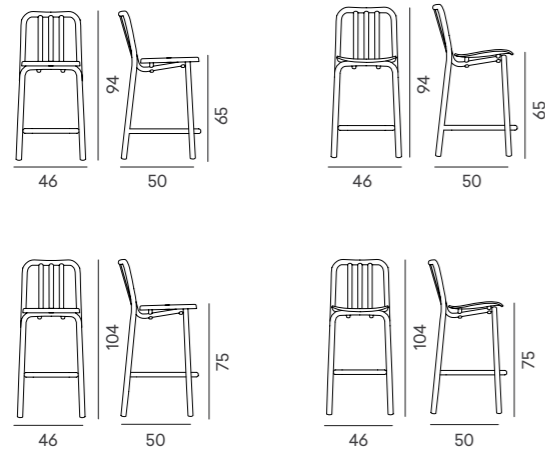

Finishes



Gimlet stool Design by Jorge Pensi

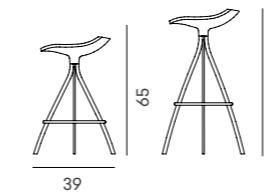

Finishes

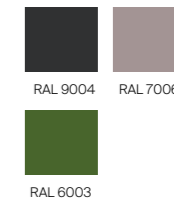

Nuta Design by Lluís Pau

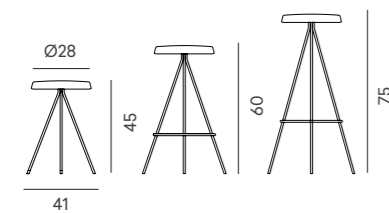

Finishes

Seat

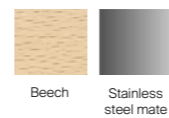

Structure

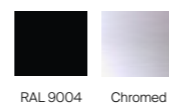

Luco Design by Martín Azúa

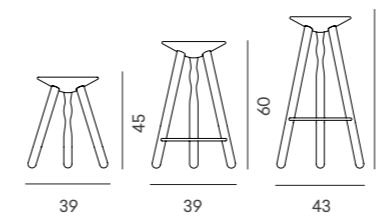

Finishes

Structure



Flod Design by Martín Azúa

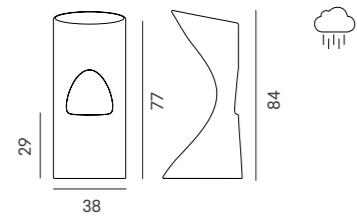

Finishes

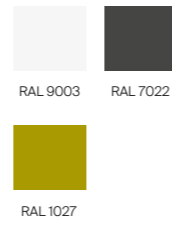

Om Design by Martín Azúa

Om basic 

Om textil

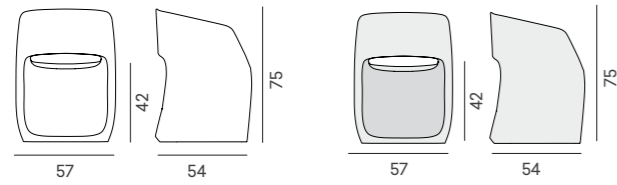

Finishes

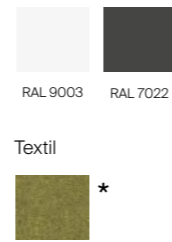

Danesa Design by Massana - Tremoleda

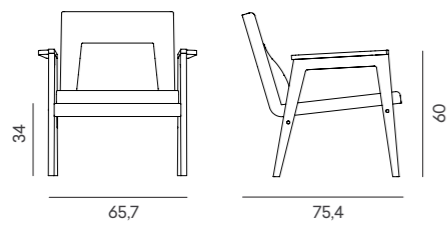

Finishes

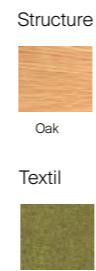

Torres Clavé 1934 Design by Josep Torres Clavé

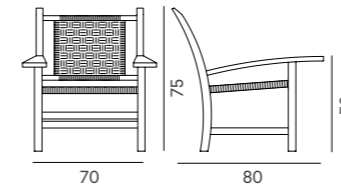

Structure



Oak

Seat



String knitted

Catalana 1942 Design by Germán Rodríguez Arias

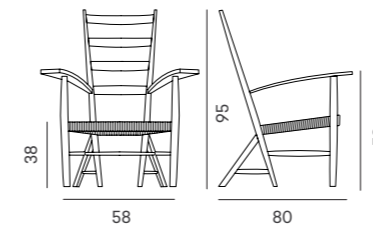

Structure



Oak

Seat



String knitted

* Check our fabric catalogue for more information (pag.146)

Tables

Gràcia table Design by Massana - Tremoleda

Rectangular table

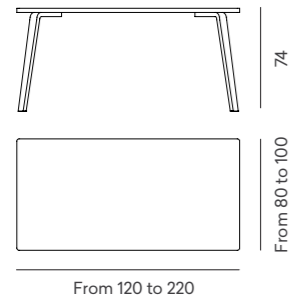

Square table

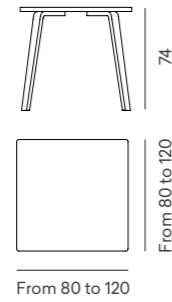

Finishes

Wood

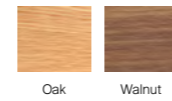

Rectangular table:

L: 120, 130, 140, 150, 160, 170, 180, 190, 200, 220

W: 80, 85, 90, 100

Square table:

80, 90, 100, 110, 120

Round table (3 legs):

Ø80, Ø90

Round table (4 legs):

Ø100, Ø110, Ø120

Optional:

Schuko plug + 2 USB



Round table (4 legs)

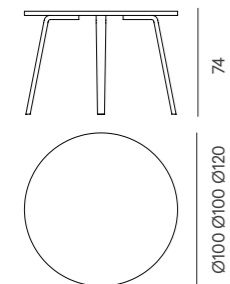

Round table (3 legs)

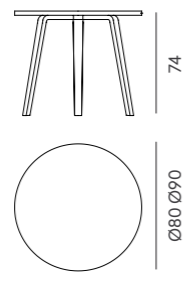

Rambla table Design by Martín Azúa

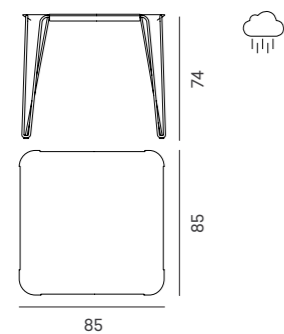

Finishes

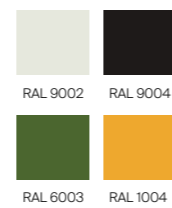

Tube table Design by Eugeni Quitllet

Round table

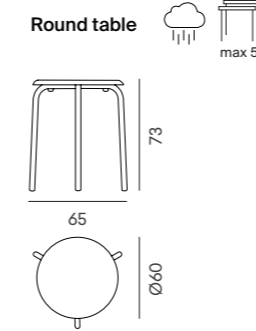

Square table

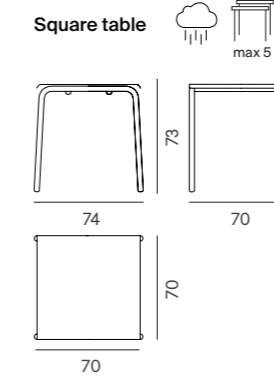

Finishes



MMS 1963 Design by Miguel Milá

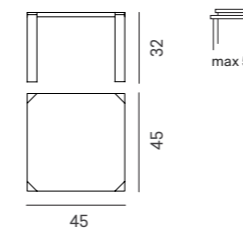

Finishes

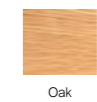

Jujol 1920 Design by Josep Maria Jujol

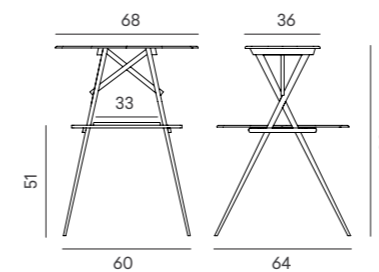

Finishes

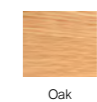

Oxi bistrot Design by Massana - Tremoleda

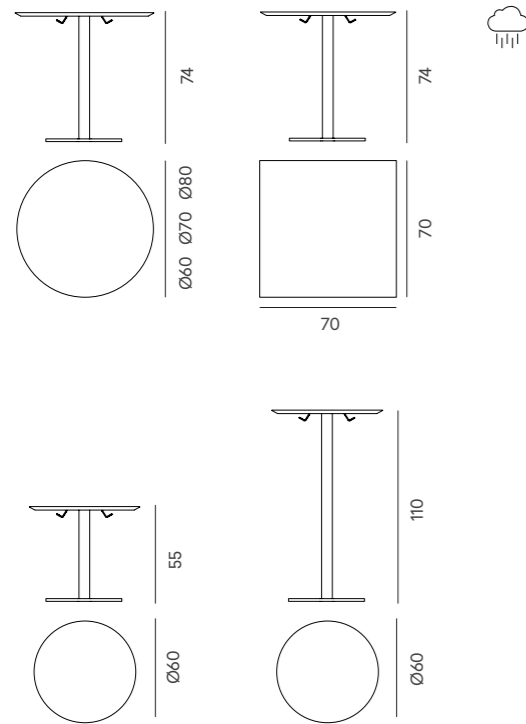

Finishes

Structure

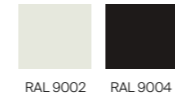

HPL Top

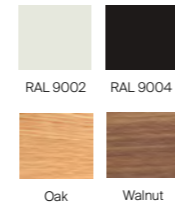

PEY central Design by Massana - Tremoleda

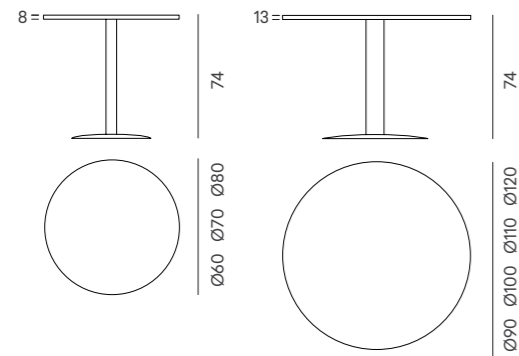

Finishes

Structure

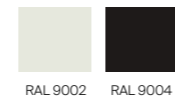

HPL Top

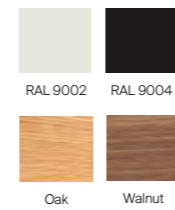

Complements

Forc Design by Lagranja design

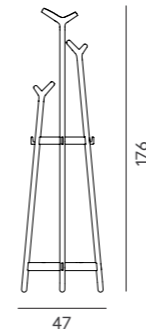

Finishes

Wood

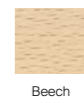

Structure

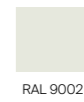

Hulot Design by Joan Gaspar

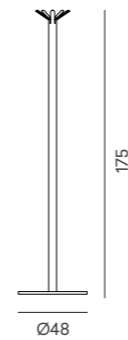

Finishes

Structure

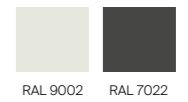

Taiga Design by Antoni Arola

Floor version
Coatstand

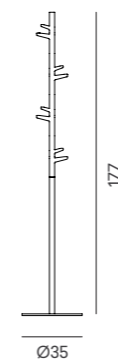

Floor version
Umbrella-coatstand

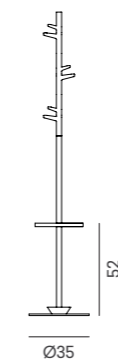

Finishes

Structure

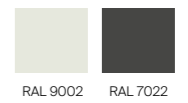

Mirac Design by Massana - Tremoleda

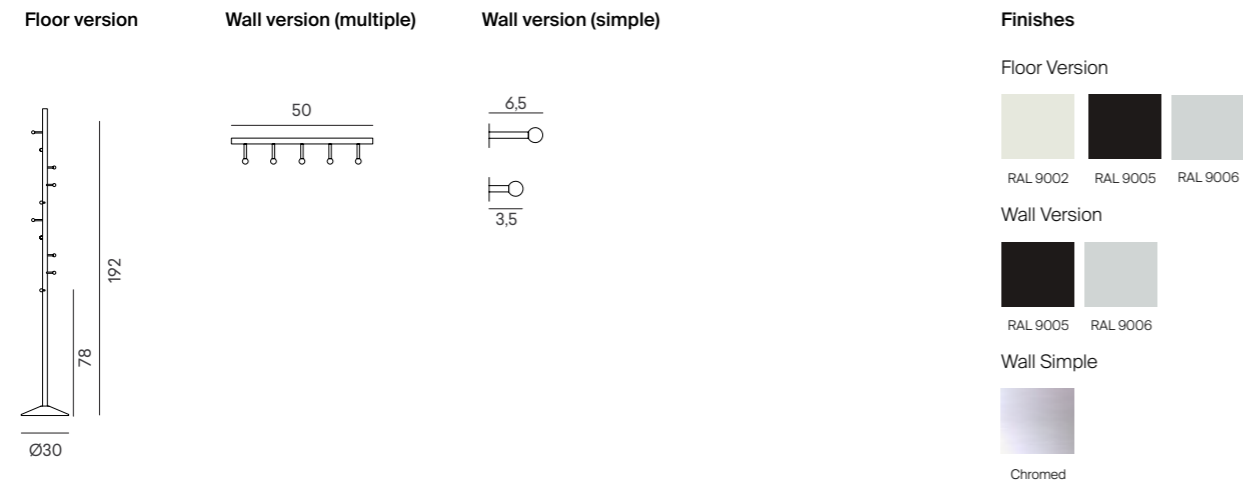

Ona Design by Montse Padrós - Carles Riart



Bambú Design by Massana - Tremoleda

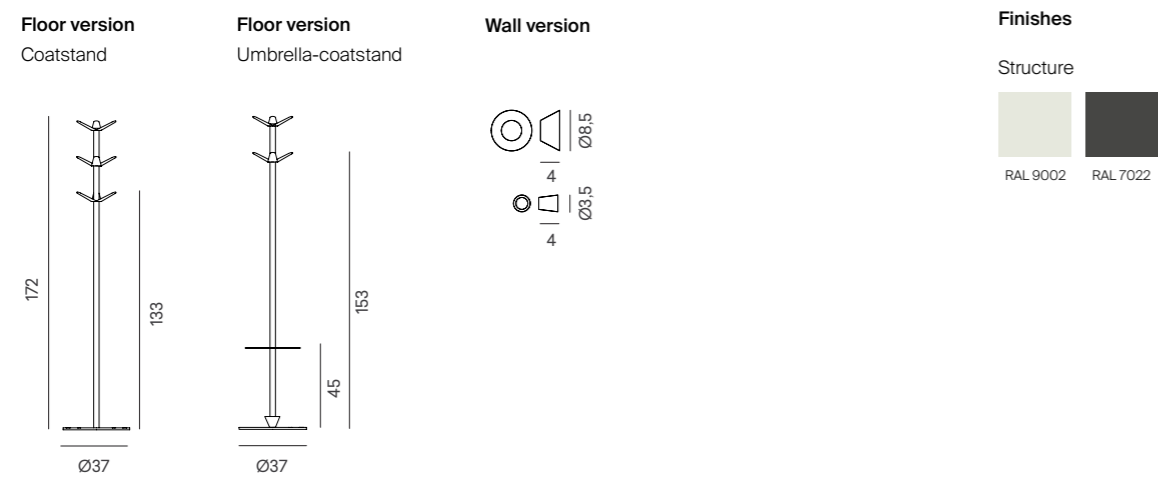

Riga Inox Design by Massana - Tremoleda

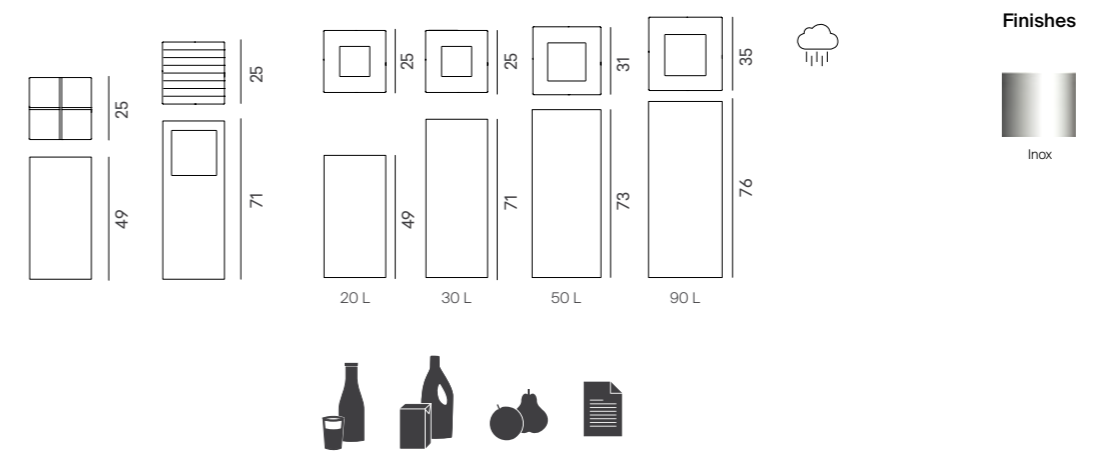

Riga Basic Design by Massana - Tremoleda

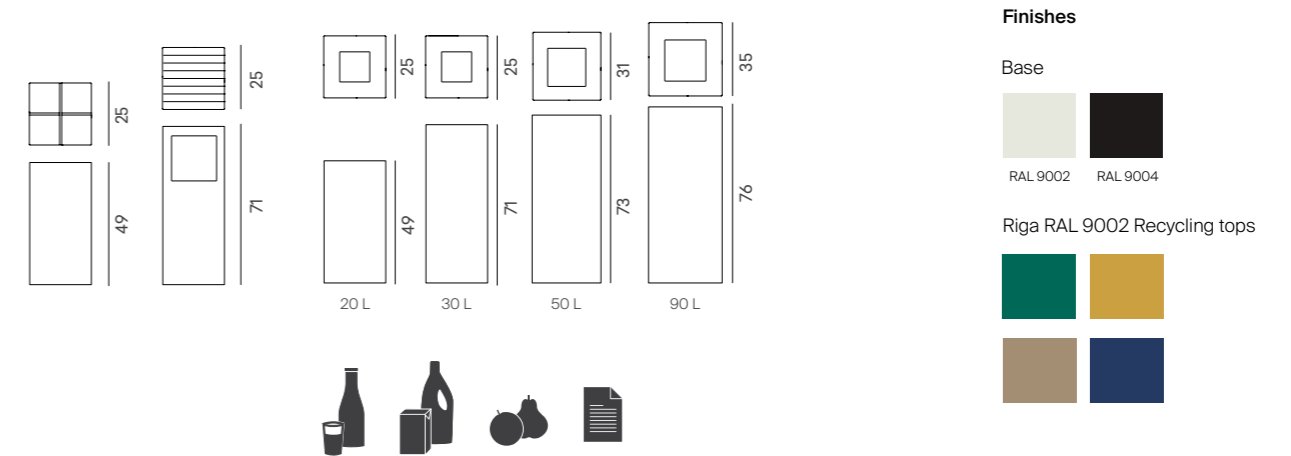

Tombal Design by Miguel Milá



Platea Design by Massana - Tremoleda

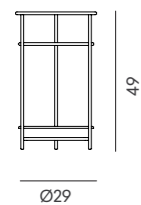

Finishes

Structure



Chromed

Recipient



RAL 9006

Fil 1991 Design by Álvaro Siza

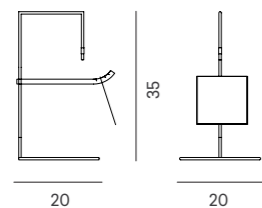

Finishes



Inox

Frac Design by Mobles 114

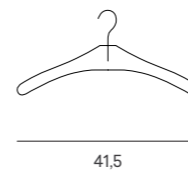

Finishes



Transparent

Circus Design by Mobles 114

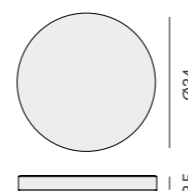

Finishes



Front Back

Copenhaguen 1966 Design by André Ricard

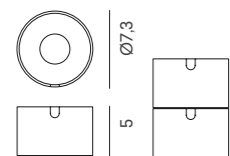

Finishes



Clac Design by Mobles 114



Finishes



Transparent

Tong 1964 Design by André Ricard

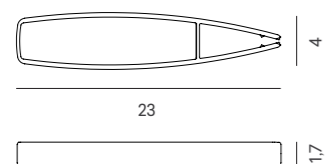

Finishes





FABRICS

Group M Mobles 114 color selection in stock

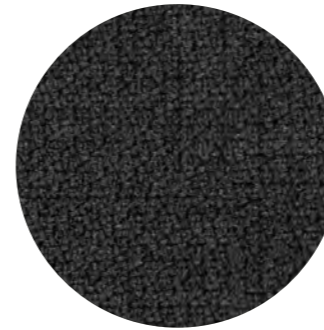

Dark Grey 60021

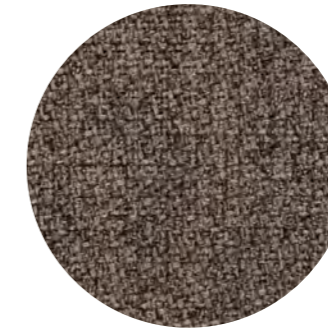

Brown 61103



Light Grey 61104

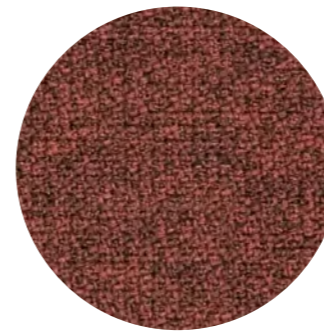

Terracotta 61151



Mustard 62057

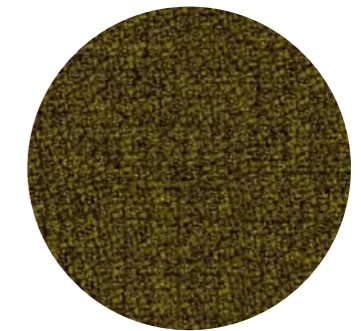

Green 68165

Name	Gabriel Step Melange
Material	Trevira CS 100%
Weight	470 g/lm · (15.16 oz/lin.yd.)
Width	140 cm · (55")
Abrasion resistance	rubs · EN ISO 12947-2 (Martindale) 100,000 double rubs wyzenbeek (ASTM D4157-07) (Heavy duty upholstery) 100,000
Pilling	scale 1-5 max. 5 · EN ISO 12945 - 2
Maintenance	Wash or dry cleaning. Can be wiped with Virkon S, Actichlor Plus, Prime Source ren 93 or Ethanol (70-85%). Always follow the manufacturer's instructions and finish by wiping with a damp cloth. 60°C · Shrinkage max. 3,0% / 74°C · Shrinkage max. 5,0%
Flammability	CA TB 117 - 2013 BS 7176 Mediu m Hazard. AM 18 - NF D 60-013-(only for fabric) · DIN 4102 B1 · NFP 92-503/504/505 M1. BS EN 1021 1&2 · BS 5852 Part 1 0,1 Cigarette & match · BS 5852 Crib 5. Class Uno UNI 9175 Class 1 EMME · ÖNORM B 3825 - B1 - 3800 - Q1 UK. FAR/JAR 25.853 (a) (i) (ii) · IMO MSC 307(88) Anne x 1 part 8. MED Certificate IMO · DIN EN 13501 - 1 B-s1, d0. Will also pass other flammability standards. Flame retardant performance is dependent upon the foam used.

Group A Gabriel Cura

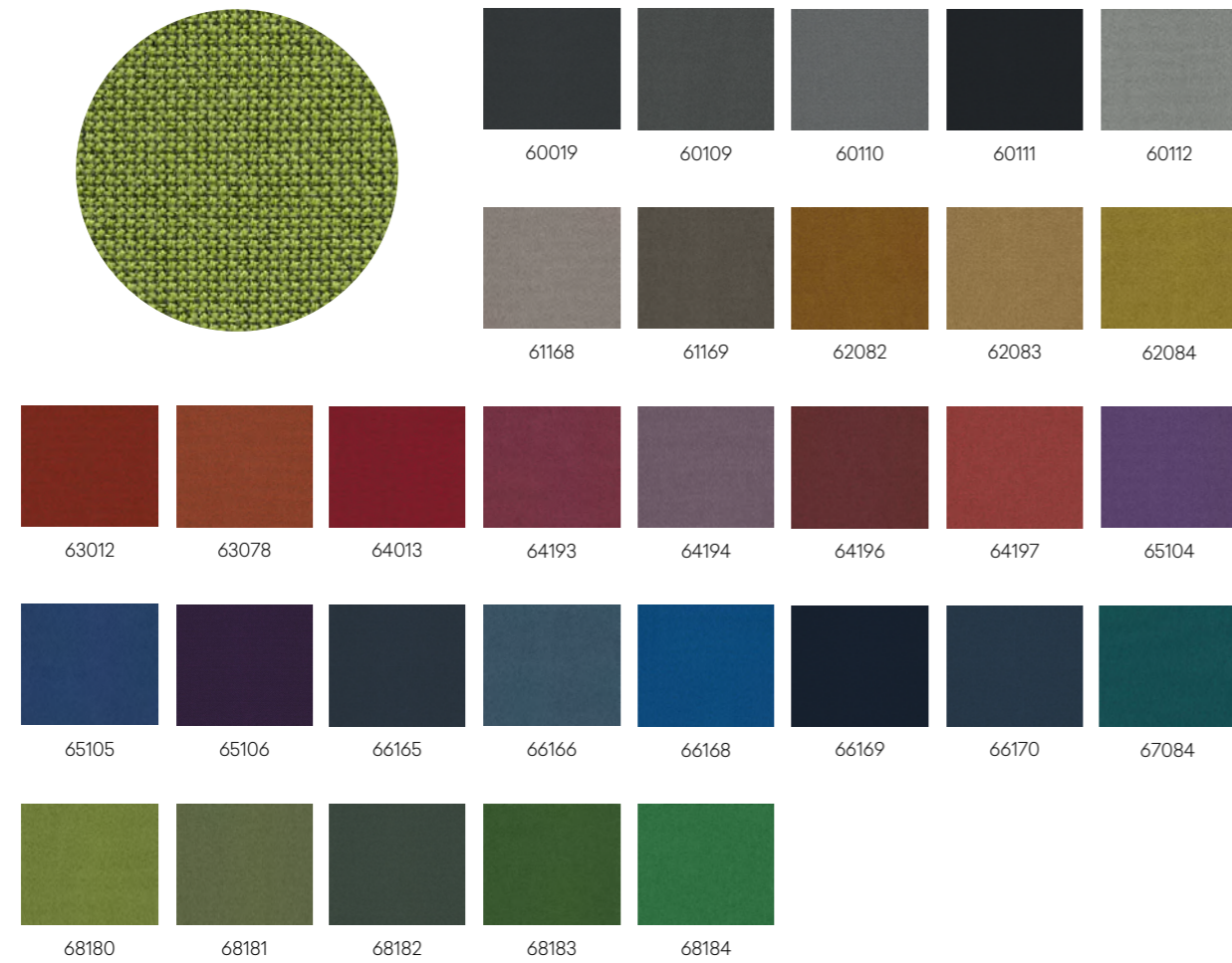

Material	post - costumer recycled polyester · polyester	98% · 2%
Weight	420 g/lm · (13.55 oz/lin.yd.)	
Width	140 cm · (55")	
Abrasion resistance	rubs · BS EN 14465 · BS EN ISO 12947-2 (Martindale)	100,000
	double rubs wyzenbeek (ASTM D4157) (Heavy Duty Upholstery)	100,000
Pilling	scale 1-5 max. 5 · EN ISO 12945-2	
Maintenance	wash or dry cleaning Flame retardant performance is dependent upon the foam used. Contain no Flame Retardant chemical.	
Flammability	EN 1021 1&2 · BS 5852 0&1 · CA TB 117 - 2013 Will also pass other flammability standards. 40°C · Shrinkage max. 1,0% 60°C · Shrinkage max. 2,0%	

Group A Spradling Valencia

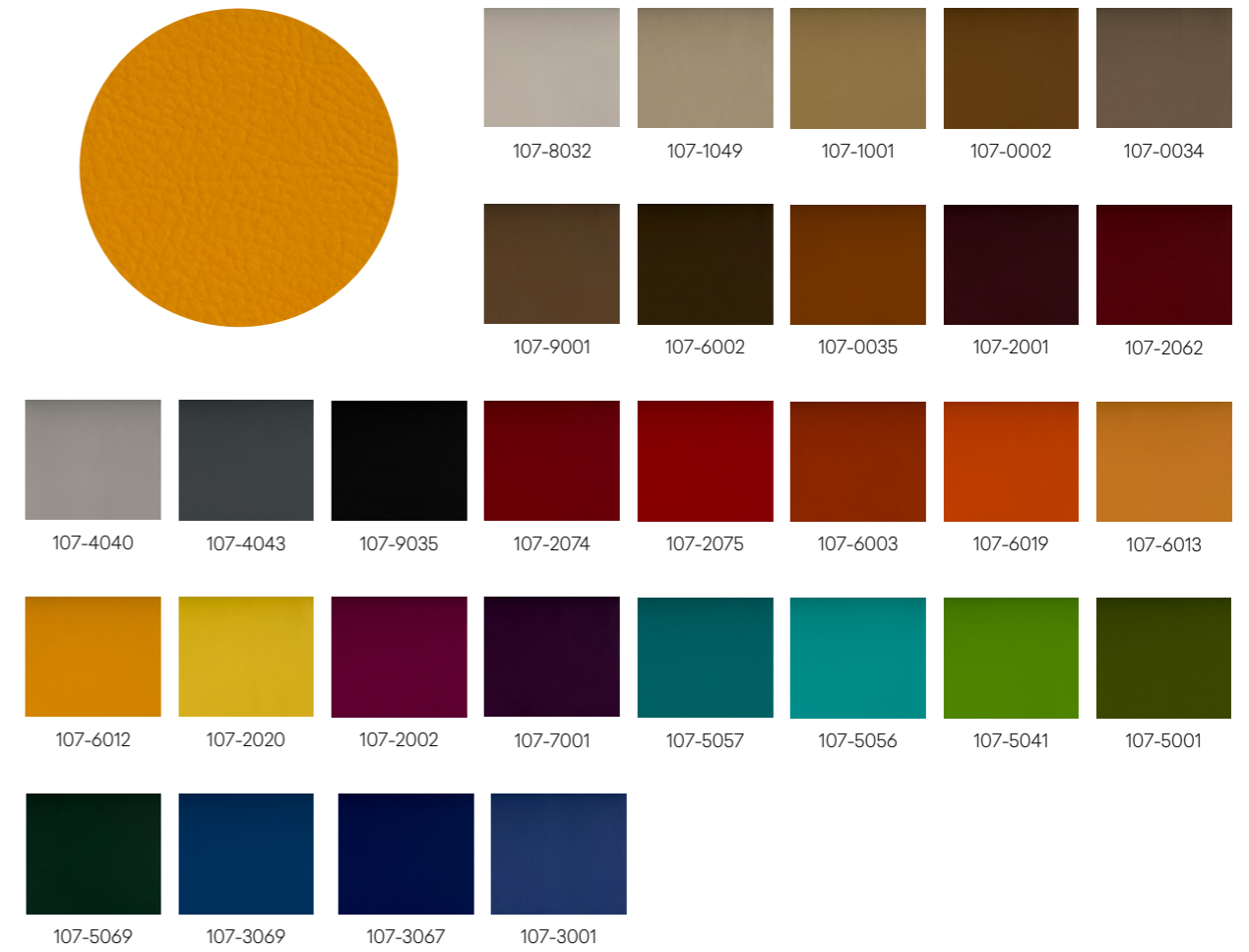

Material	Vinyl / Urethane
Weight	650 g/m2
Width	137 cm · (53")
Abrasion resistance	>300.000 cycled (Martindale)
Pilling	scale 1-5 max. 5 · EN ISO 12945 - 2
Maintenance	For light soiling, a solution of 10% household liquid dishsoap in warm water, applied with a soft damp cloth. Rinse with clean water and dry. Do not use with alcohol based cleaning agents.
Flammability	EN 1021 1&2 · ES: UNE 23.727-90 1R/M.2 · FR: NF P 92-503/M2 DE: DIN 4102 B2 · AT: ÖNORM B 3825, Gruppe 1 - Schwerbrennbares IT: UNI 9175 (1987) / UNI 9175/FA1 (1994) Classe 1.IM (UNO I EMME) AT: ÖNORM A 3800 Teil 1, Qualmbildungsklasse Q1 - schwachqualmend IMO FTP 2010 Code MSC.307 (88) Part 8 3.1 & 3.2 · US: FMVSS 302 US: FAR 25/853 · ECE R118.02 (replaces Directive 95/28/CE) 6, 7 & 8 EN 71-2:2006+A1:2007 - Safety of Toys - Parte 2: Flammability

Group B Gabriel Step

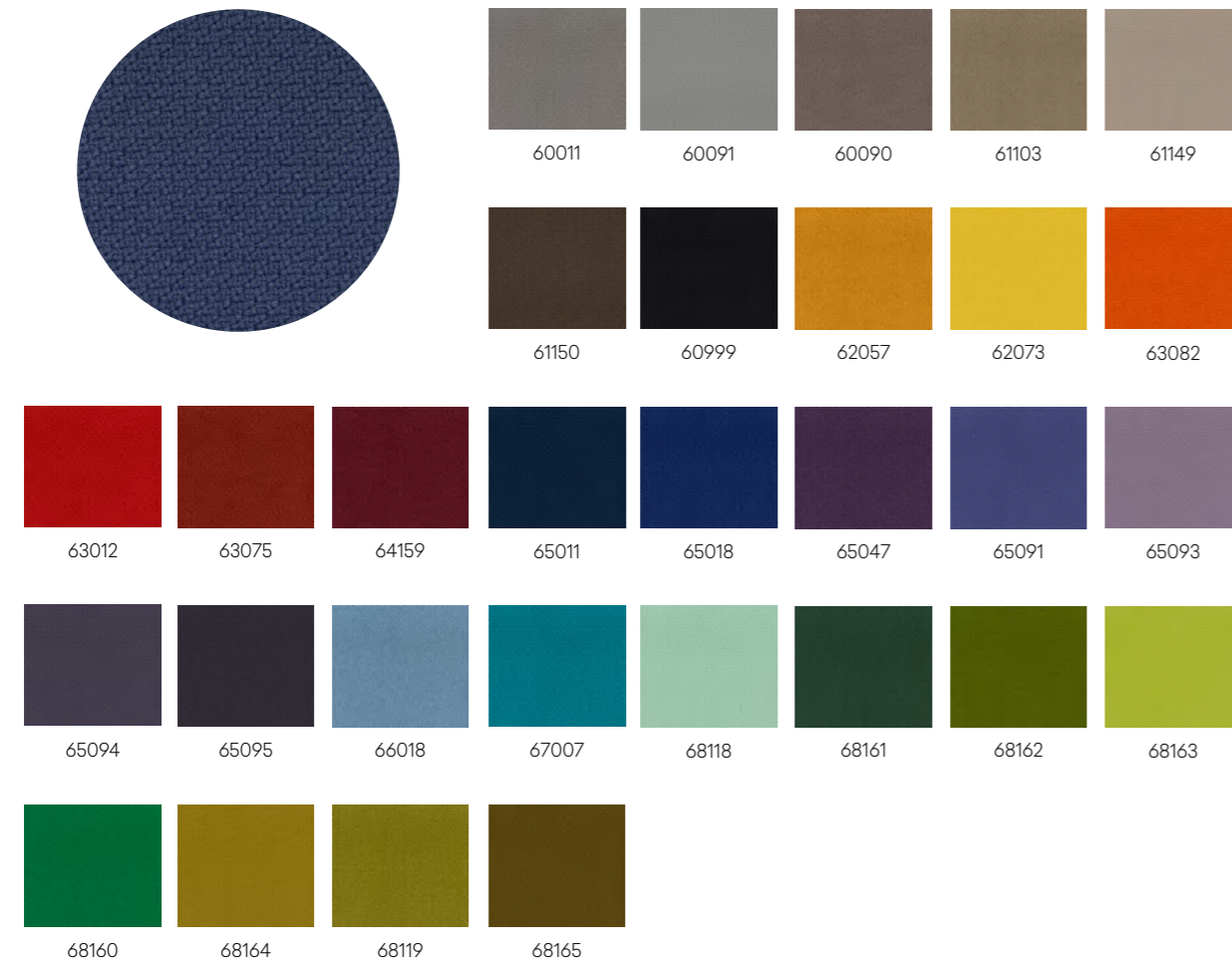

Material	Trevira CS	100%
Weight	470 g/lm · (15.16 oz/lin.yd.)	
Width	140 cm · (55")	
Abrasion resistance	rubs · EN ISO 12947-2 (Martindale) 100,000 double rubs wyzenbeek (ASTM D4157-07) (Heavy duty upholstery) 100,000	
Pilling	scale 1-5 max. 5 · EN ISO 12945 - 2	
Maintenance	Wash or dry cleaning. Can be wiped with Virkon S, Actichlor Plus, Prime Source ren 93 or Ethanol (70-85%). Always follow the manufacturer's instructions and finish by wiping with a damp cloth. 60°C · Shrinkage max. 3,0% / 74°C · Shrinkage max. 5,0%	
Flammability	CA TB 117 - 2013 BS 7176 Mediu m Hazard. AM 18 - NF D 60-013-(only for fabric) · DIN 4102 B1 · NFP 92-503/504/505 M1. BS EN 1021 1&2 · BS 5852 Part 1 0,1 Cigarette & match · BS 5852 Crib 5. Class Uno UNI 9175 Class 1 EMME · ÖNORM B 3825 - B1 - 3800 - Q1 UK. FAR/JAR 25.853 (a) (i) (ii) · IMO MSC 307(88) Anne x 1 part 8. MED Certificate IMO · DIN EN 13501 - 1 B-s1, d0. Will also pass other flammability standards. Flame retardant performance is dependent upon the foam used.	

Group B Gabriel Step Melange



Material	Trevira CS	100%
Weight	470 g/lm · (15.16 oz/lin.yd.)	
Width	140 cm · (55")	
Abrasion resistance	rubs · EN ISO 12947-2 (Martindale) 100,000 double rubs wyzenbeek (ASTM D4157-07) (Heavy duty upholstery) 100,000	
Pilling	scale 1-5 max. 5 · EN ISO 12945 - 2	
Maintenance	Wash or dry cleaning. Can be wiped with Virkon S, Actichlor Plus, Prime Source ren 93 or Ethanol (70-85%). Always follow the manufacturer's instructions and finish by wiping with a damp cloth. 60°C · Shrinkage max. 3,0% / 74°C · Shrinkage max. 5,0%	
Flammability	CA TB 117 - 2013 BS 7176 Mediu m Hazard. AM 18 - NF D 60-013-(only for fabric) · DIN 4102 B1 · NFP 92-503/504/505 M1. BS EN 1021 1&2 · BS 5852 Part 1 0,1 Cigarette & match · BS 5852 Crib 5. Class Uno UNI 9175 Class 1 EMME · ÖNORM B 3825 - B1 - 3800 - Q1 UK. FAR/JAR 25.853 (a) (i) (ii) · IMO MSC 307(88) Anne x 1 part 8. MED Certificate IMO · DIN EN 13501 - 1 B-s1, d0. Will also pass other flammability standards. Flame retardant performance is dependent upon the foam used.	

Group C Gabriel Capture

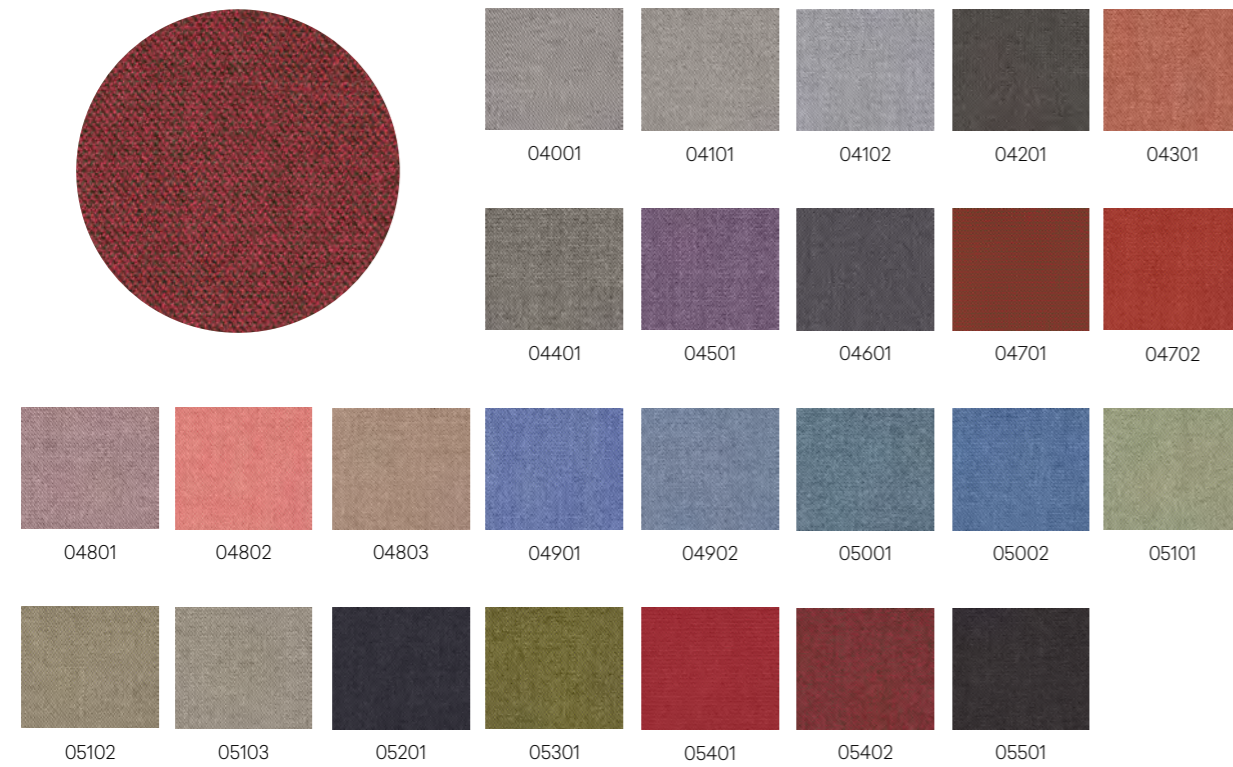

Material	New Zealand wool · polyamide	85% · 15%
Weight	475 g/lm 3 (15.32 oz/lin.yd.)	
Width	140 cm · (55")	
Abrasion resistance	rubs · BS EN 14465 · BS EN ISO 12947 - 2 (Martindale) rubs 200,000 Martindale · ASTM D4966 - 02 (Heavy Duty Upholstery) 200,000	
Pilling	scale 1-5 max. 5 · EN ISO 12945 - 2	
Maintenance	dry cleaning	
Flammability	EN 1021 1&2 · BS 5852 0&1 · CA TB 117 - 2013. Class Uno UNI 9175 Class 1 EMME Will also pass other flammability standards. Flame retardant performance is dependent upon the foam used. Contain no Flame Retardant chemical.	

Group C Kvadrat Remix 2



Material	New wool · Nylon	90% · 10%
Weight	415 g/lm · (14.63 oz/lin.yd.)	
Width	138 cm · (54")	
Abrasion resistance	rubs · EN ISO 12947 (Martindale)	100.000
Pilling	Note 4, EN ISO 12945	
Maintenance	Vacuuming and dry cleaning	
Flammability	AS/NZS 1530.3 · BS 5852 Crib 5 with treatment · BS 5852 part 1. EN 1021-1/2 · IMO FTP Code 2010: Part 8 · NF D 60 013 · NFPA 260. Önorm B1/Q1 · UNI 9175 1IM · US Cal. Bull. 117-2013. No use of brominated flame retardants	

Group D Kvadrat Divina Melange

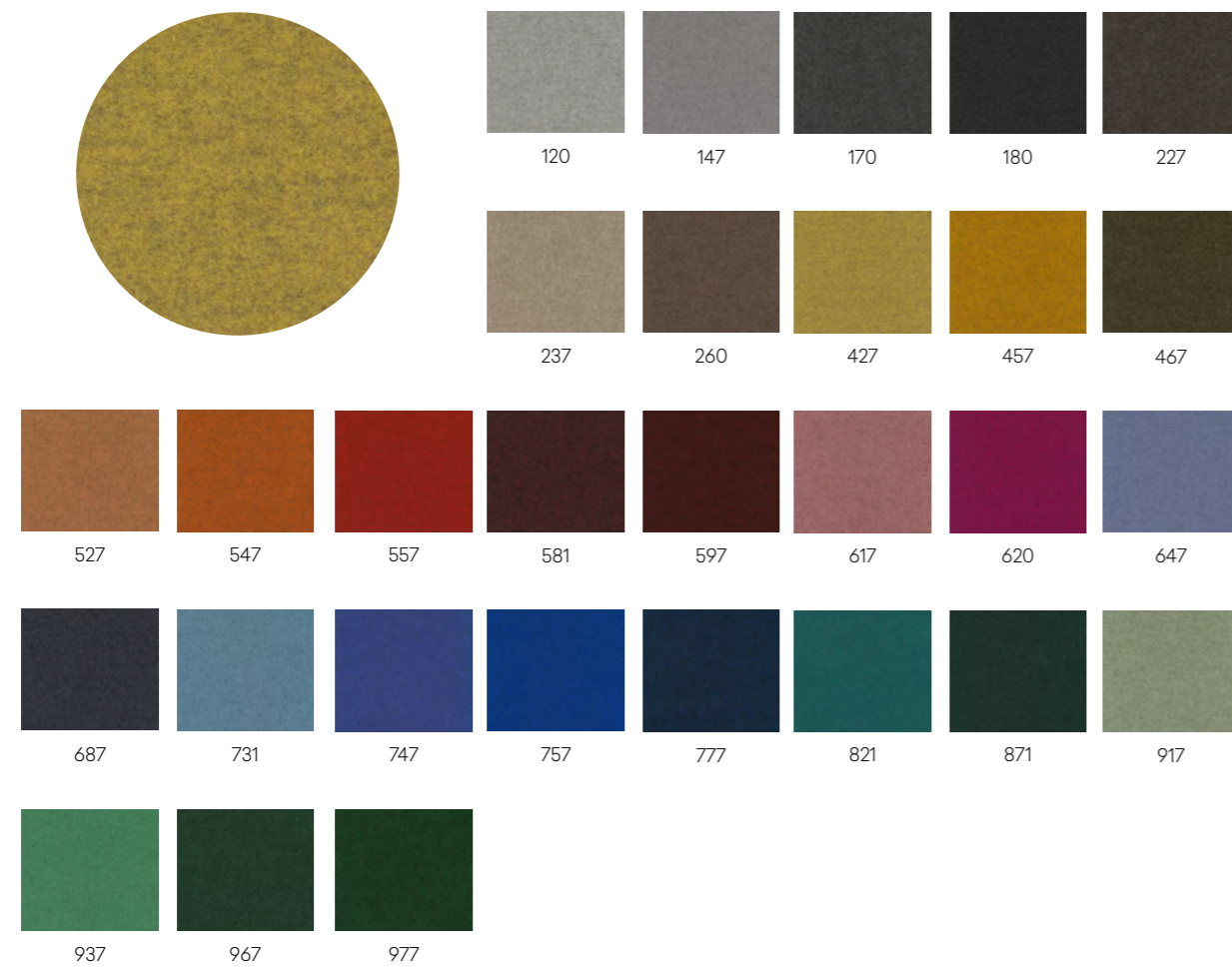

Material	New wool	100%
Weight	820 g/lin.m	
Width	150 cm · (59")	
Abrasion resistance	rubs · EN ISO 12947 (Martindale)	45.000
Pilling	Note 3, EN ISO 12945	
Maintenance	Vacuuming and dry cleaning	
Flammability	AS/NZS 1530.3, BS 5852 Crib 5, BS 5852 ignition source 3, BS 5852 part 1, BS 5867 part 2 type B, EN 1021-1/2, EN 13501, C-s1, d0, glued, NF D 60 013, NFPA 260, SN 198 898 5.3 with treatment *, UNI 9175 1IM, US Cal. Bull. 117-2013, ÖNORM B1/Q1	

Group D Kvadrat Steelcut Trio 3

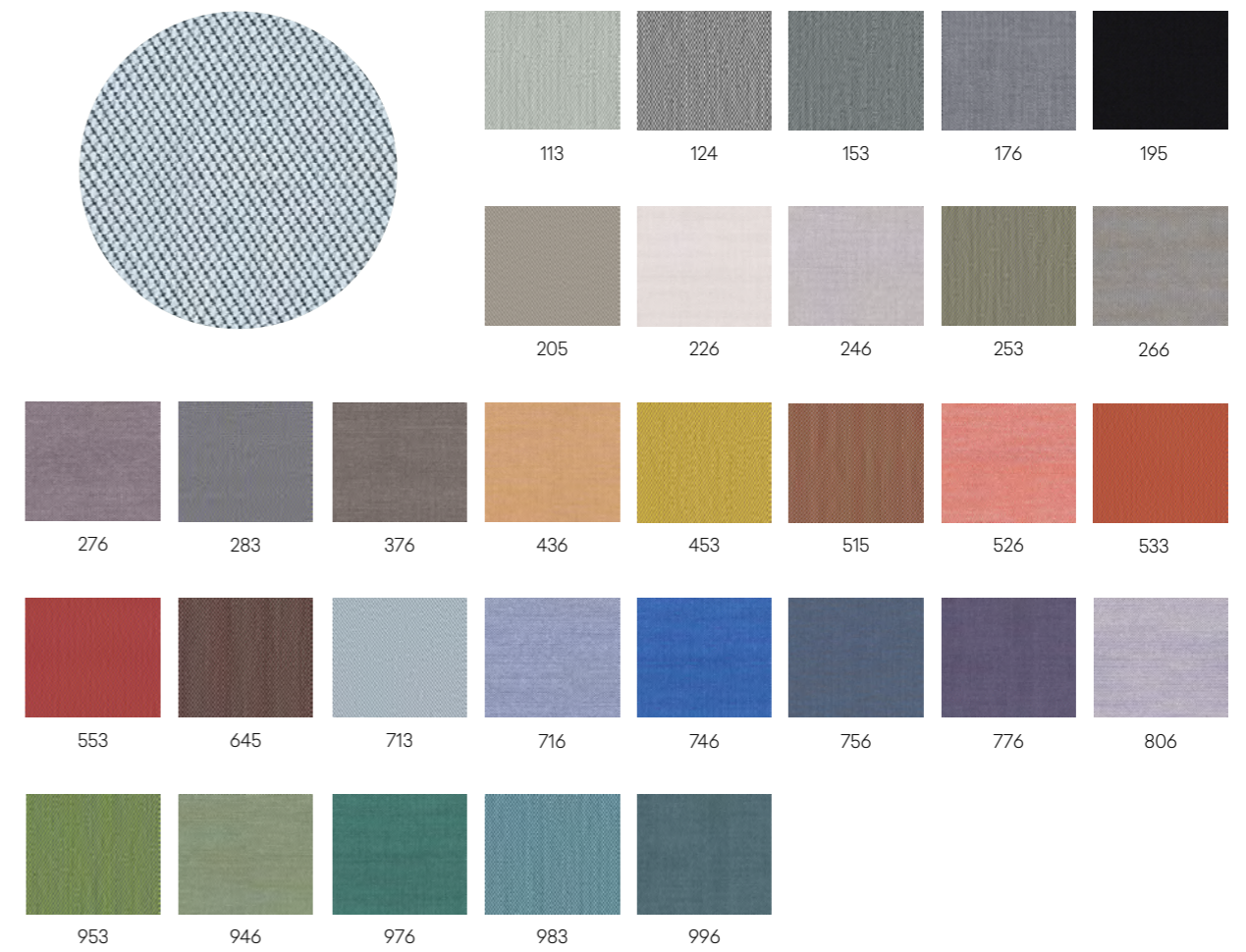

Material	New wool · Nylon	90% · 10%
Weight	770 g/lm · (27,16 oz/lin.yd.)	
Width	140 cm · (55")	
Abrasion resistance	rubs · EN ISO 12947 (Martindale)	100.000
Pilling	Note 4, EN ISO 12945	
Maintenance	Vacuuming and dry cleaning	
Flammability	AS/NZS 1530.3 · AS/NZS 3837 class 2 · BS 5852 Crib 5 with treatment BS 5852 part 1 · DIN 4102 B2 · EN 1021-1/2 · IMO FTP Code 2010: Part 8 NF D 60 013 · NFPA 260 · Önorm B1/Q1 · SN 198 898 5.3 with treatment UNI 9175 1IM · US Cal. Bull. 117-2013 No use of brominated flameretardants	

