

a

by arturo alvarez

nevo collection

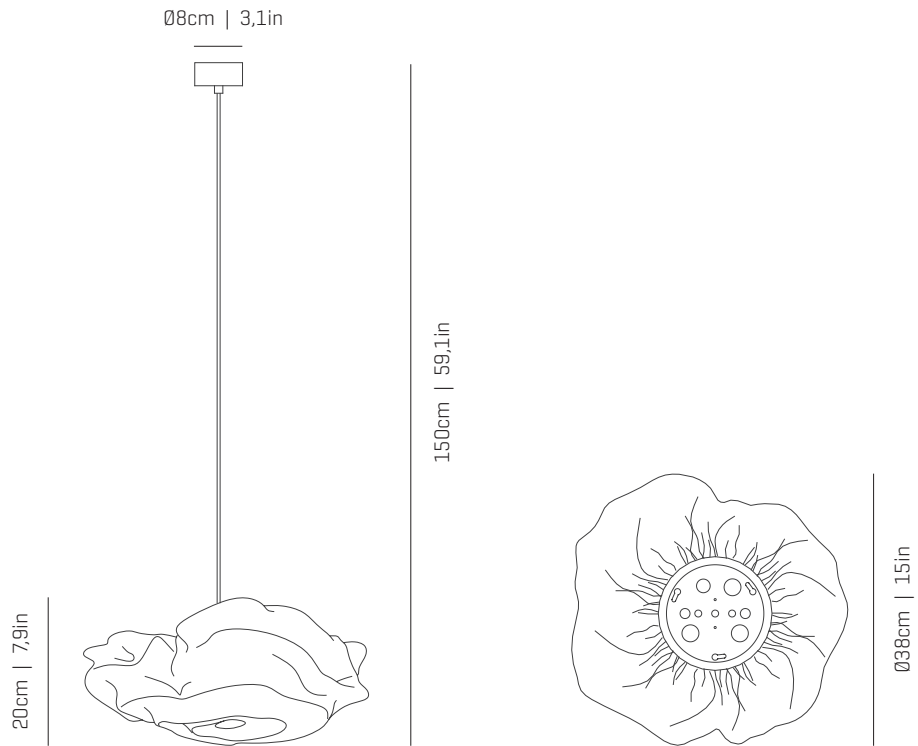

ref. NE04-1

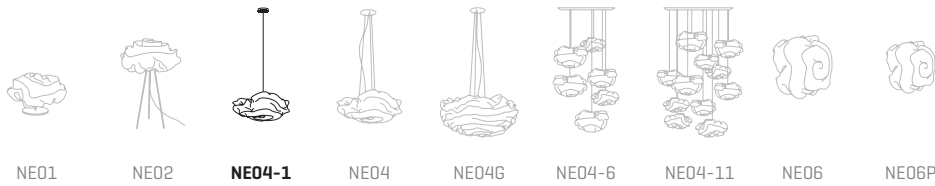

MATERIALS & COMPONENTS | MATERIALES & COMPONENTES

LAMP SHADE | TULIPA

Painted stainless steel | One color to choose
Acero inoxidable pintado | Un color a elegir

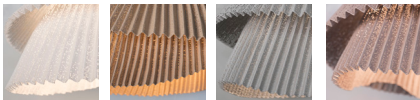

BL

BE

G

T

CUSTOM
COLOR

Steel gloss nickel-plated and stainless steel
Acero níquel-satinado y acero inoxidable

CANOPY AND CABLE

FLORÓN Y CABLE

Steel gloss nickel-plated
Acero níquel-satinado

Transparent cable
Cable transparente

Standard: 150cm | 59,1in
Length/largo customizable
120V: 200cm | 78,7in

RECOMMENDED BULBS

BOMBILLAS RECOMENDADAS

230V - 50Hz

E14 LED Vintage - Max. 2x7 W

E14 LED Standard - Max. 2x7 W

120V - 60Hz

E12 LED - Max. 2x7 W

ENERGY EFFICIENCY

EFICIENCIA ENERGÉTICA

from A++ to E
desde A++ a E

OTHER DATA | OTROS DATOS

NET WEIGHT | PESO NETO

1,2kg | 2,6lb

PACKAGING | EMBALAJE

36x36x31cm | 14,2x 14,2x 12,2in
2,3kg | 5lb

ELECTRICAL FEATURES

CARACTERÍSTICAS ELÉCTRICAS



CERTIFICATIONS

CERTIFICACIONES



a

by arturo alvarez

nevo collection

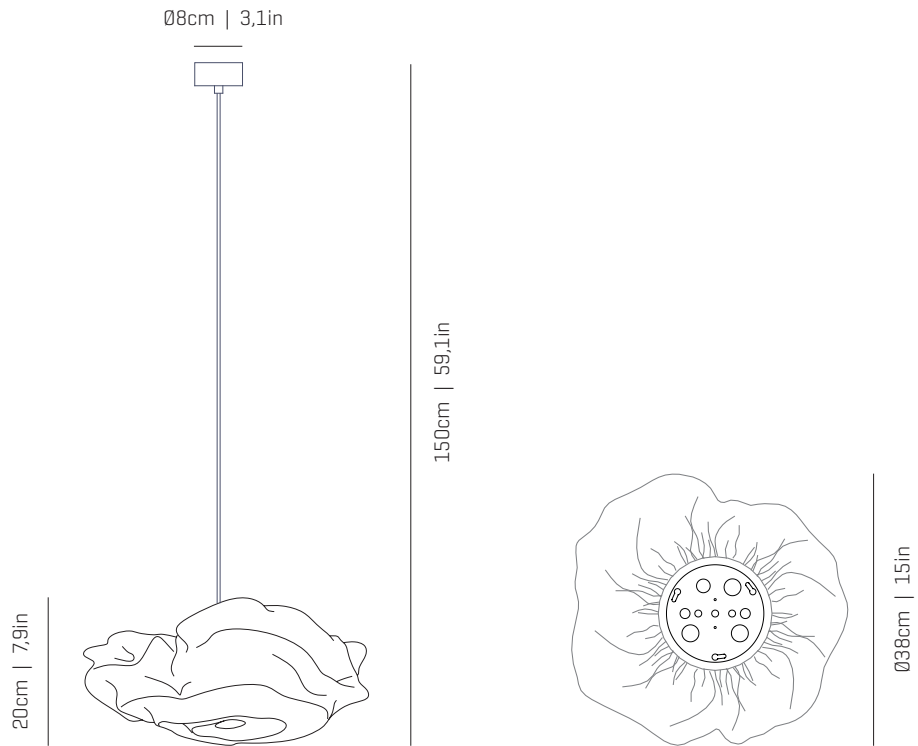

ref. NE04-1

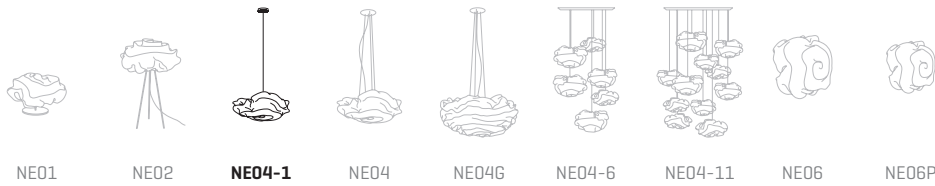

MATERIALS & COMPONENTS | MATERIALES & COMPONENTES

LAMP SHADE | TULIPA

Painted stainless steel | One color to choose
Acero inoxidable pintado | Un color a elegir

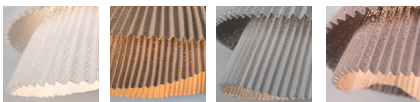

BL

BE

G

T

CUSTOM
COLOR

Steel gloss nickel-plated and stainless steel
Acero níquel-satinado y acero inoxidable

CANOPY AND CABLE

FLORÓN Y CABLE

Steel gloss nickel-plated and stainless steel
Acero níquel-satinado y acero inoxidable

Transparent or black cable
Cable transparente o negro

Standard: 150cm | 59,1in
Length/largo customizable
120V: 200cm | 78,7in

RECOMMENDED BULBS

BOMBILLAS RECOMENDADAS

230V - 50Hz

 E14 LED Vintage - Max. 2x7 W

 E14 LED Standard - Max. 2x7 W

120V - 60Hz

 E12 LED - Max. 2x7 W

ENERGY EFFICIENCY

EFICIENCIA ENERGÉTICA

from A++ to E
desde A++ a E

OTHER DATA | OTROS DATOS

NET WEIGHT | PESO NETO

1,2kg | 2,6lb

PACKAGING | EMBALAJE

36x36x31cm | 14,2x 14,2x 12,2in
2,3kg | 5lb

ELECTRICAL FEATURES

CARACTERÍSTICAS ELÉCTRICAS



CERTIFICATIONS

CERTIFICACIONES



Nevo

ref. NE04-1

Suitable for indoor use, at 25°C

Apta para uso interior a temperatura ambiente de 25°C

Box contains | Contenido de la caja:

- | | |
|---|--|
| A - Lampshade Tulipa [1] | E - Electrical disposal Ficha [1] |
| B - Holding piece Pieza de sujeción [1] | F - Screws Tornillos [2] |
| C - Lampholder Portalámparas [1] | G - Canopy Florón [1] |
| D - Security screws Tornillos de seguridad [2] | H - Wall Plugs Tacos [2] |



SAFETY NOTE: Switch off mains supply before commencing installation

INDICACIÓN DE SEGURIDAD : Desconecte la alimentación eléctrica antes de empezar la instalación

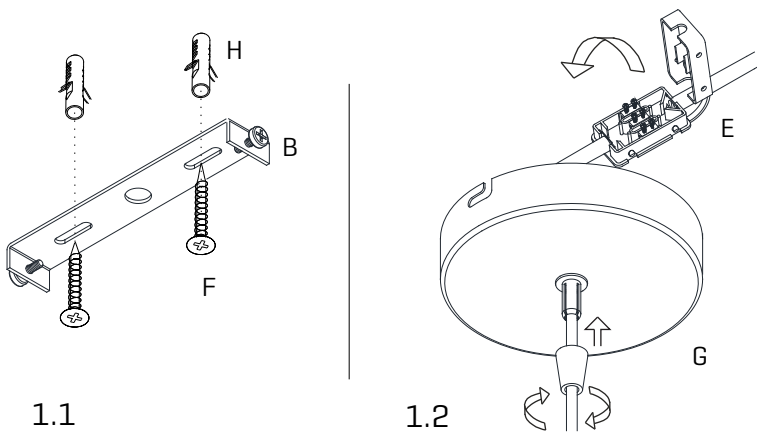

1

1.1 Drill the holes in the ceiling, fit the wall plugs into them and screw the holding piece.
1.2 Pass the electric cables to the interior and do the electric connection, please follow the instructions.

1.1 Realizar los agujeros en el techo, colocar los tacos y atornillar la pieza de sujeción.
1.2 Pasar los cables eléctricos al interior y hacer la conexión eléctrica dentro de la caja de conexiones, siguiendo las instrucciones.

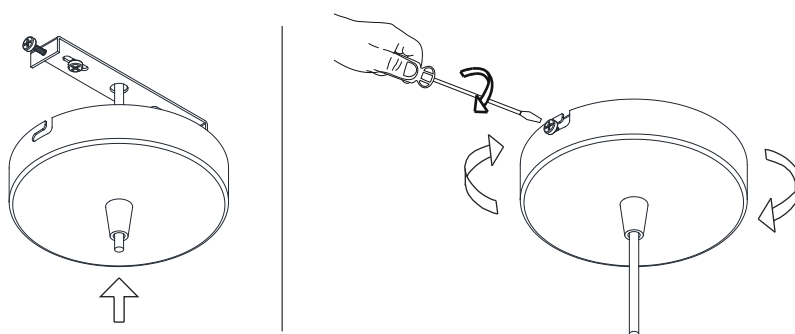

2

Insert the canopy in the holding piece and tight the security screws.
Tighten the strain relief situated on the canopy.

Encajar el florón en la pieza de sujeción y apretar los tornillos de seguridad.
Apretar el tensor del cable situado en el florón.

a

by arturo alvarez

ASSEMBLY INSTRUCTIONS
INSTRUCCIONES DE MONTAJE

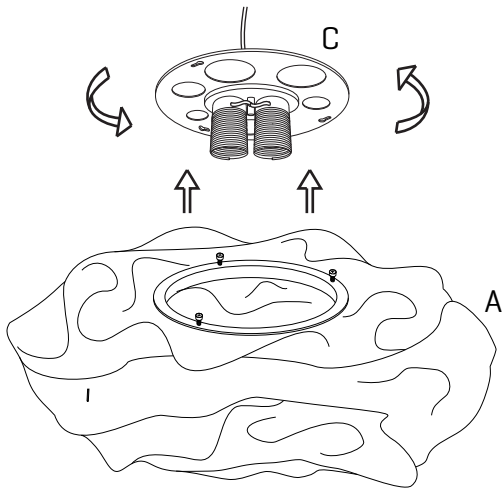

3

Place the light bulbs. Fit the lampshade in the diffuser[metal hoop] grooves and turn it until it reaches the endstop. Tight the fillet of the fixing screws to fasten the shade and the whole set.

Colocar las bombillas. Encajar la tulipa en las rendijas del soporte y girarla hasta que haga tope. Apretar la rosca de los tornillos de enganche para asegurar el conjunto.