

# a

by arturo alvarez

curvas collection

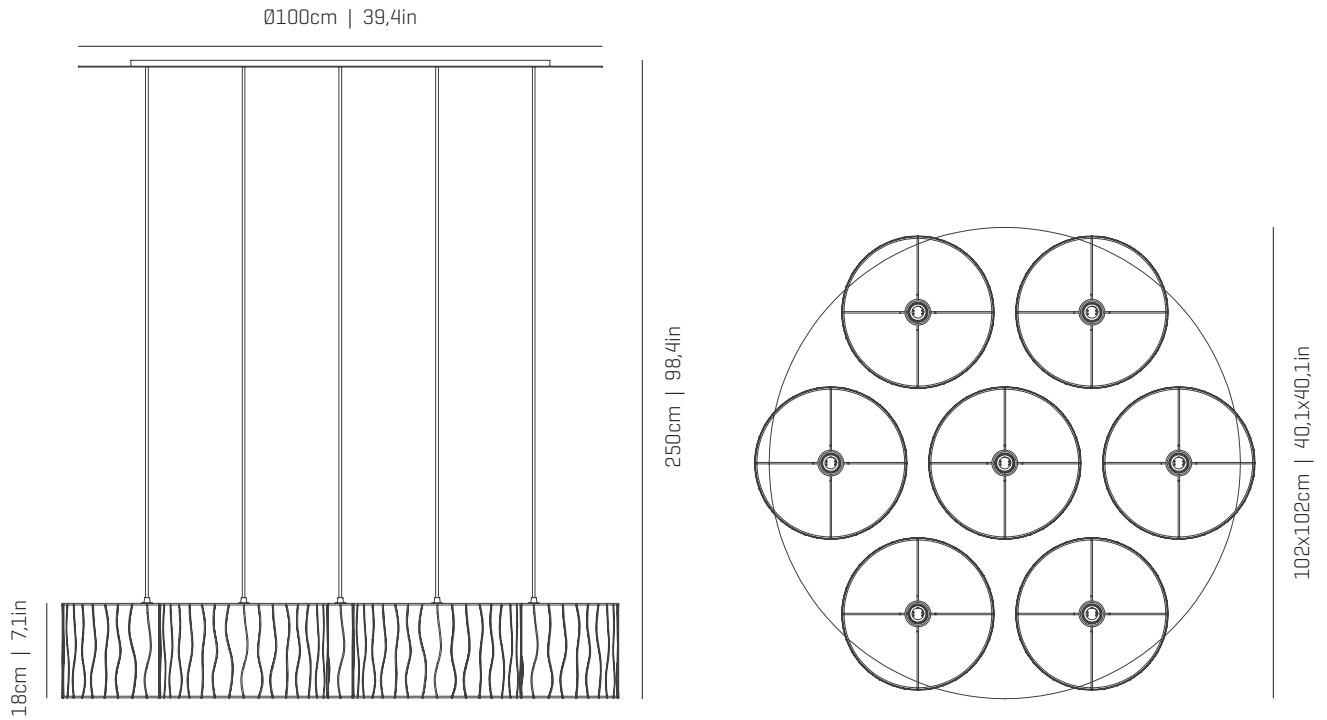

ref. CV04-7

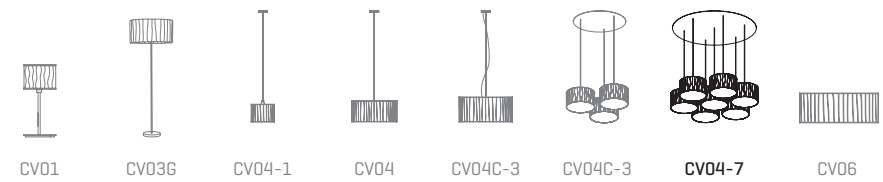

## MATERIALS & COMPONENTS | MATERIALES & COMPONENTES

### LAMP SHADE | TULIPA

Glass | One color to choose  
Vidrio | Un color a elegir

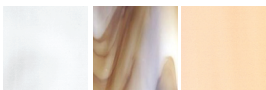

02 95 87



89 90

Bottom diffuser | Difusor inferior

ref. 7xCV04

### CANOPY AND CABLE | FLORÓN Y CABLE

DIBOND®

Transparent or black cable  
Cable transparente o negro

Length/largo customizable

### RECOMMENDED BULBS

BOMBILLAS RECOMENDADAS

#### 230V - 50Hz

- E27 LED Vintage - Max. 7x12 W
- E27 LED Standard - Max. 7x12 W

#### 120V - 60Hz

- E26 LED - Max. 7x12 W

### ENERGY EFFICIENCY

EFICIENCIA ENERGÉTICA

from A++ to E  
desde A++ a E

## OTHER DATA | OTROS DATOS

### NET WEIGHT | PESO NETO

18kg | 39,7lb

### PACKAGING | EMBALAJE

80x120x125cm | 31,5x 47,2x 49,2in  
35kg | 77lb

### ELECTRICAL FEATURES

CARACTERÍSTICAS ELÉCTRICAS



### CERTIFICATIONS

CERTIFICACIONES



by arturo alvarez

## Curvas

ref. CV04 - 7

Suitable for indoor use, at 25°C

Apta para uso interior a temperatura ambiente de 25°C

Box contains | Contenido de la caja:

- A** - Lampshade | Tulipas [7]
- B** - Canopy | Florón [1]
- C** - Frame | Soporte [1]
- D** - Cap | Tapón [3]
- E** - Screws | Tornillos [4]
- F** - Wall plug | Tacos [4]
- G** - Electrical disposal | Ficha conexión [1]

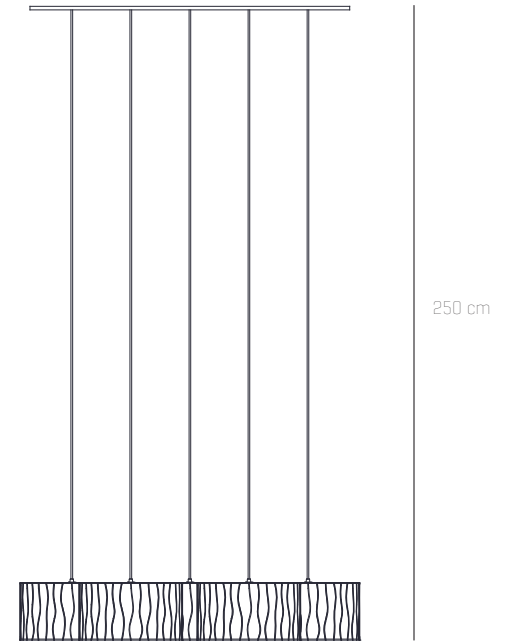
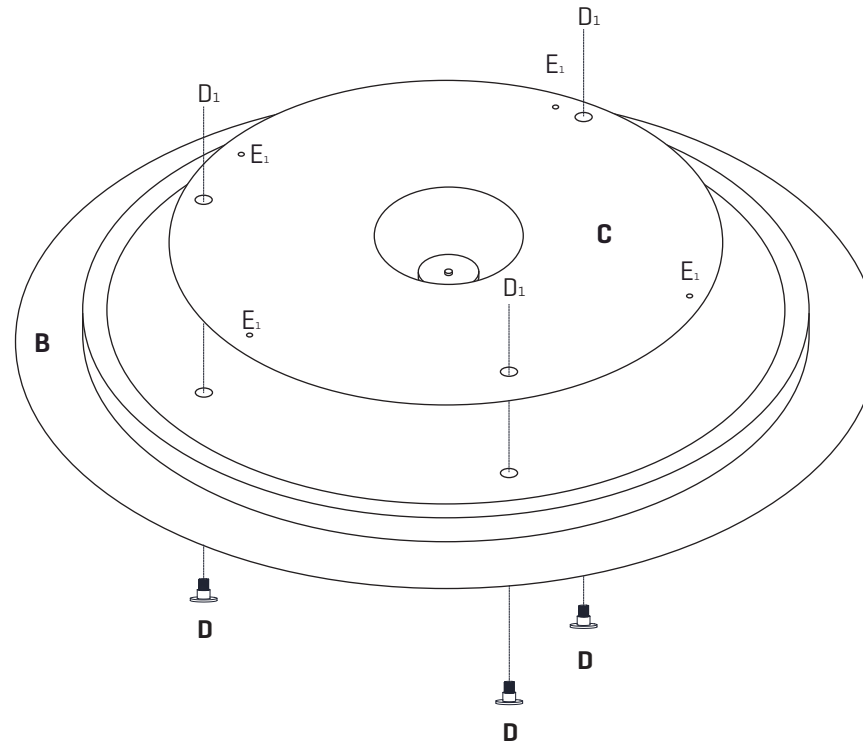

FRONTAL VIEW | VISTA FRONTAL

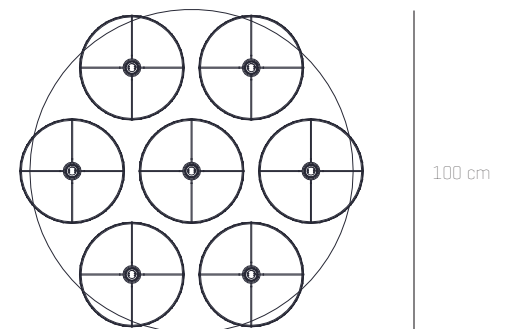

BOTTOM VIEW | VISTA INFERIOR  
POSITION LAMP SHADES | POSICIÓN DE LAS TULIPAS

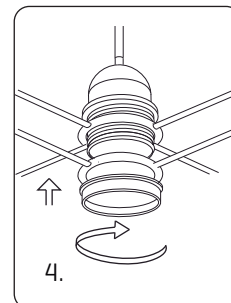
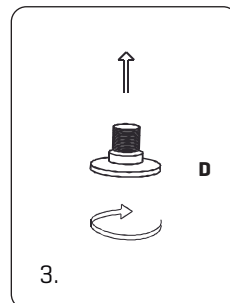
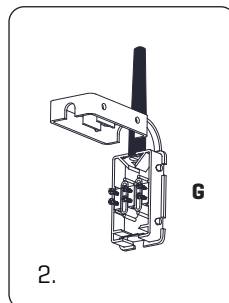
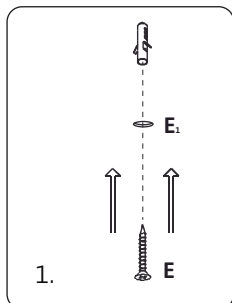

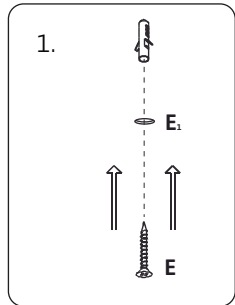

1. Make holes in the ceiling as marked in the frame with the letter E., insert the wall plugs and fix the frame.

\* Our plugs are appropriate for concrete ceilings only

1. Hacer los taladros en su techo según los marcados en el soporte con la letra E., colocar los tacos y fijar el soporte.

\* Nuestros tacos son sólo aptos para superficies de hormigón

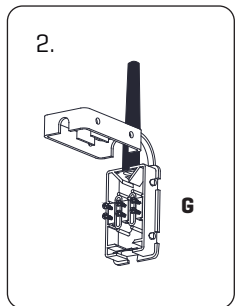

2. Pass the electrical wires inside the electrical disposal G.

The power cables from the wall shouldn't exceed the dimension of the black hose connection box provided, as shown in Fig. 2.1

Make the electrical connections taking care to respect the correct polarity as the color code.

2. Pasar los cables eléctricos al interior de la caja de conexiones G.

Los cables de alimentación procedentes de la pared no deben exceder la dimensión del manguito negro de la caja de conexiones suministrada, tal y como se indica en la figura 2.1

Realizar la conexión eléctrica teniendo cuidado de respetar la polaridad correcta según el código de colores.

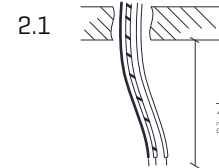

2.1

COLOR CODE: PHASE [L] - BLACK OR BROWN / NEUTRAL [N] - BLUE / EARTHING [E] - GREEN&YELLOW

CÓDIGO DE COLORES: FASE [L] - NEGRO O MARRÓN / NEUTRO [N] - AZUL / TOMA TIERRA [E] - VERDE&AMARILLO

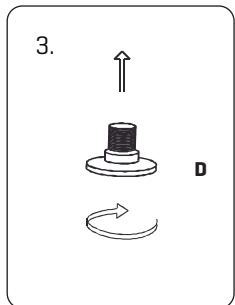

3. Once the frame is fixed, screw the caps in the holes marked with D.

3. Colocado el soporte, enroscar los tapones en los taladros marcados con la letra D.

4. To access the inside of the luminaire and to install the bulbs, remove the lower diffuser tilting it.

4. Para acceder al interior de la luminaria y colocar la bombilla quitar el difusor inferior inclinándolo.

