

a

by arturo alvarez

cors collection

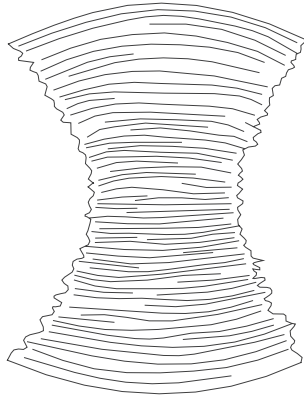

40cm | 15.7in

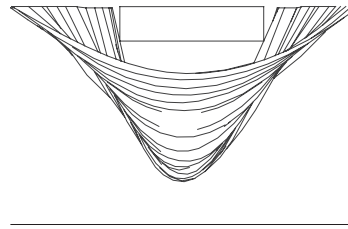

15cm | 5.9in

30cm | 11.8in

ref. CR06



GE06

MATERIALS & COMPONENTS | MATERIALES & COMPONENTES

LAMP SHADE | TULIPA

Painted stainless steel | One color to choose
Acero inoxidable pintado | Un color a elegir

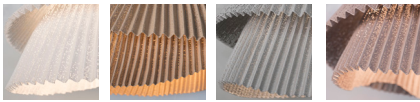

BL

BE

G

T

CUSTOM
COLOR

SUPPORT AND MOUNTING OPTIONS

SOPORTE Y OPCIONES DE INSTALACIÓN

Stainless steel
Acero inoxidable

Wall lamp
Aplique

RECOMMENDED BULBS

BOMBILLAS RECOMENDADAS

230V - 50Hz

 G9 LED - Max. 2x4 W

120V - 60Hz

 G9 LED - Max. 2x4 W

ENERGY EFFICIENCY

EFICIENCIA ENERGÉTICA

from A+ to C
desde A+ a C

OTHER DATA | OTROS DATOS

NET WEIGHT | PESO NETO

0,6kg | 1,3lb

PACKAGING | EMBALAJE

51x19x27cm | 20,1x 7,5x 10,6in

1kg | 2,2lb

ELECTRICAL FEATURES

CARACTERÍSTICAS ELÉCTRICAS



CERTIFICATIONS

CERTIFICACIONES



Cors

ref. CR06

Suitable for indoor use, at 25°C

Apta para uso interior a temperatura ambiente de 25°C

Box contains | Contenido de la caja:

A - Lampshade | Tulipa [1]

B - Holding piece | Pieza de sujeción [1]

C - Lampholder | Portalámparas [2]

D - Security screws | Tornillos de seguridad [2]

E - Electrical disposal | Ficha [1]

F - Screws | Tornillos [2]

G - Wall Plugs | Tacos [2]

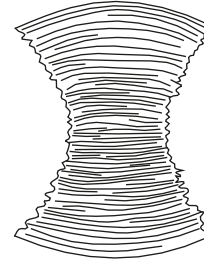

SAFETY NOTE: Switch off mains supply before commencing installation

INDICACIÓN DE SEGURIDAD : Desconecte la alimentación eléctrica antes de empezar la instalación

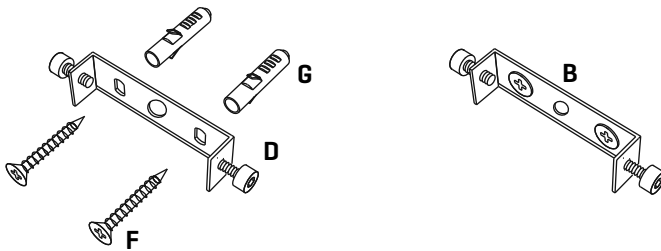

1

Drill the holes in the ceiling, fit the wall plugs into them and screw the holding piece.

Realizar los agujeros en el techo, colocar los tacos y atornillar la pieza de sujeción.

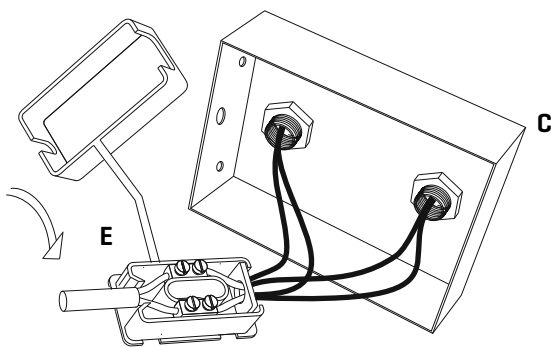

2

Fit the shade in the base, turn it until it reaches the end stop by inserting the fixing screws to the slots of the canopy. Tighten the fillet of the fixing screws to fasten the whole set.

Encajar la tulipa en el soporte, girándola hasta que haga tope al introducir los tornillos de enganche en las ranuras del florón. Apretar la rosca de los tornillos de enganche para asegurar el conjunto.

a

by arturo alvarez

ASSEMBLY INSTRUCTIONS
INSTRUCCIONES DE MONTAJE

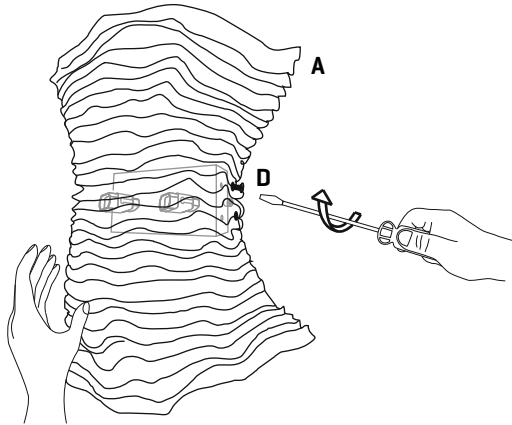

3

Join the shade to the base, by screwing a pair of screws on each side.

Unir la tulipa en el soporte, atornillando la pareja de tornillos de cada lado.



The device is not suitable for installation on normally inflammable surfaces.

Aparato no adaptado para la instalación en superficies normalmente inflamables.