



KATALOGUE · CATALOGUE · CATÁLOGO

**SWAA**



Designed by Johnny dos Passos

## INSPIRATION

L'INSPIRATION

INSPIRACIÓN | A INSPIRAÇÃO

DIE INSPIRATION

Comes and goes in a Perpetual movement.

When it flows through you, stay awake. | Vai

e vem num movimento Perpétuo. Quando ela

passar por ti, presta-lhe atenção. | Viene y se

va en el movimiento Perpetuo. Al pasar junto

a ti, verlo. | Va et vient dans un mouvement

Perpétuel. Quand elle te frôle, sois attentif. |

Kommt und geht in einer ewigen Bewegung.

Wenn Sie an dir vorbeizieht nehme Sie wahr.

*Johnny Dos Passos*  
Designer



02 |



25

22 |



10

34 |

12



06



31



## NOW AND TOMORROW.

The history of our company was built on great challenges, with more than 50 years of experience in furniture manufacturing, our main concern is designing items that reflect original expressions of great aesthetic variety, freedom of composition and custom solutions. Using the most modern productive resources, investing in research and development of new products, a young and qualified team, we combine the most innovative materials, finishes and colours that make a distinct and innovative product. Our mission is to demonstrate the company's expertise and ability to supply products that satisfy the desires of our customers.

## MAINTENANT ET DEMAIN.

C'est en relevant de grands défis que nous avons construit notre histoire avec une expérience de plus de 50 ans dans la fabrication de Meubles. Notre principale préoccupation est de concevoir des objets qui traduisent une expression originale, une grande variété esthétique, de la modulation et des solutions personnalisées. En utilisant des ressources de production moderne et en investissant dans la recherche et le développement de nouveaux produits, nous avons recours à une équipe de jeunes techniciens hautement qualifiés. Avec nos Designers nous combinons les matériaux innovants avec des finitions et des couleurs qui anticipent les tendances du marché pour proposer des produits distincts et intemporels. Notre mission principale est de mettre nos compétences au service de nos clients pour concrétiser aujourd'hui leurs projets de demain.

## AHORA Y MAÑANA.

A partir de grandes desafíos se ha fraguado nuestra historia, con una experiencia de más de 50 años en la fabricación de mobiliario, su principal preocupación reside en concebir objetos que se traduzcan en expresiones originales de gran variedad estética, libertad de composición y soluciones personalizadas. Utilizando los más modernos recursos productivos, la inversión en investigación y desarrollo de nuevos productos, un equipo joven y cualificado, combinamos los materiales más innovadores, acabados y colores, que se traducen en un producto distinto e innovador. Nuestra misión es demostrar la competencia y capacidad de la empresa en el suministro de productos capaces de concretar los deseos de nuestros clientes.

## AGORA E AMANHÃ.

É de grandes desafios que se faz a nossa história, com uma experiência de mais de 50 anos na fabricação de mobiliário, tem a preocupação dominante de conceber objetos que se traduzam em expressões originais de grande variedade estética, liberdade de composição e soluções personalizadas. Utilizando os mais modernos recursos produtivos, o investimento em investigação e desenvolvimento de novos produtos, uma equipa jovem e qualificada, combinamos os materiais mais inovadores, acabamentos e cores que se traduzem num produto distinto e inovador. A nossa missão é evidenciar a competência e capacidade da empresa no fornecimento de produtos capazes de concretizar os desejos dos nossos clientes.

## JETZT UND MORGEN.

Es sind die großen Herausforderungen, die die Geschichte unser Unternehmen, die mehr als 50 Jahre Erfahrung in der Herstellung von Möbeln hat, ausmacht. Die Firma beschäftigt sich vorwiegend mit dem Entwurf von Objekten, die ursprüngliche Ausdrücke großer ästhetischer Vielfalt, freie Zusammenstellung und individuelle Lösungen aufweisen. Unter Einsatz der modernsten Produktionsmittel, Investition in Forschung und Entwicklung und eines jungen sowie qualifizierten Teams, kombinieren wir die innovativsten Materialien, Oberflächenbehandlungen und Farben, um ein herausragendes Produkt herzustellen. Unsere Mission besteht darin, die Kompetenz und Fähigkeit unser Unternehmen bei der Präsentation von Produkten, die in der Lage sind, die Wünsche unserer Kunden zu konkretisieren.







SWAA

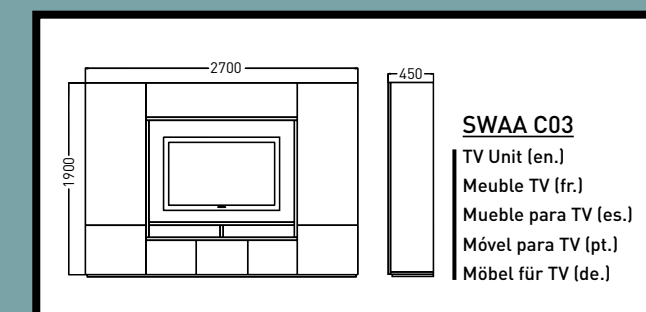



living room tv unit++ zoom out

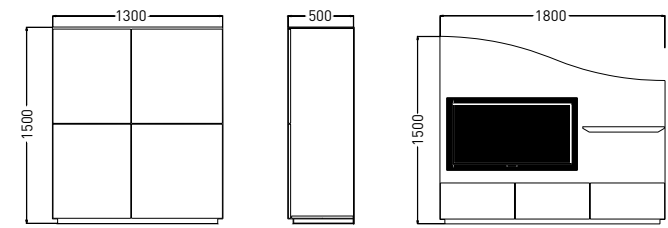

**SWAA C01**

TV Unit (en.)  
 Meuble TV (fr.)  
 Mueble para TV (es.)  
 Móvel para TV (pt.)  
 Möbel für TV (de.)



living room    table + tv unit++    zoom out

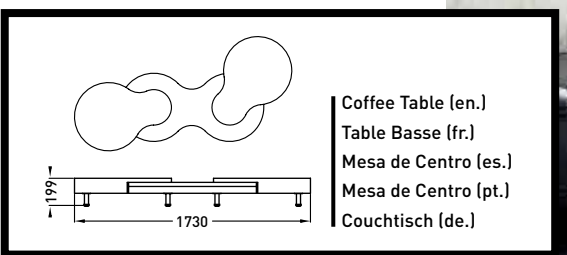

Coffee Table (en.)  
 Table Basse (fr.)  
 Mesa de Centro (es.)  
 Mesa de Centro (pt.)  
 Couchtisch (de.)

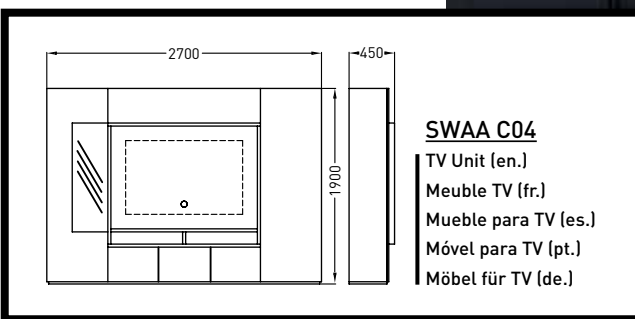

**SWAA C04**  
 TV Unit (en.)  
 Meuble TV (fr.)  
 Mueble para TV (es.)  
 Móvel para TV (pt.)  
 Möbel für TV (de.)



living room    table + tv unit++    zoom out

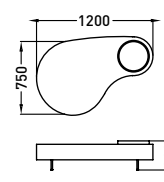

Coffee Table (en.)  
Table Basse (fr.)  
Mesa de Centro (es.)  
Mesa de Centro (pt.)  
Couchtisch (de.)

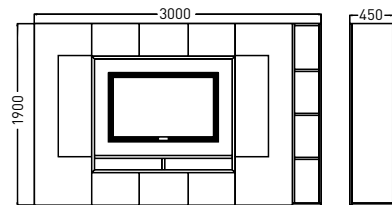

SWAA C02  
TV Unit (en.)  
Meuble TV (fr.)  
Mueble para TV (es.)  
Móvel para TV (pt.)  
Möbel für TV (de.)





living room      tv unit++      zoom out

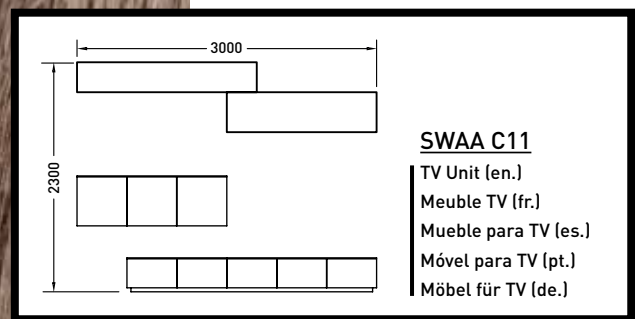



dinning room    sideboard++    zoom out





dinning room

table and sideboard++

zoom out





table++ zoom in

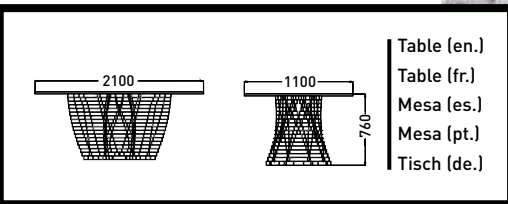
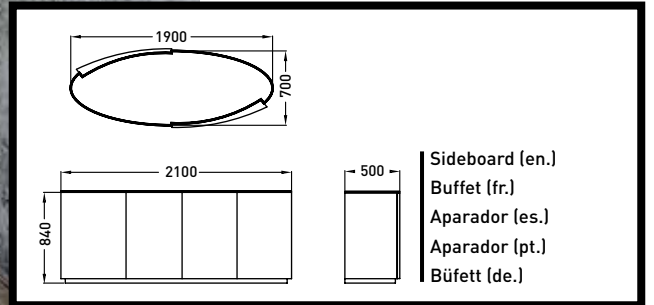

Table (en.)  
Table (fr.)  
Mesa (es.)  
Mesa (pt.)  
Tisch (de.)

sideboard++ zoom in



Sideboard (en.)  
Buffet (fr.)  
Aparador (es.)  
Aparador (pt.)  
Büfett (de.)







dinning room table and sideboard++ zoom out

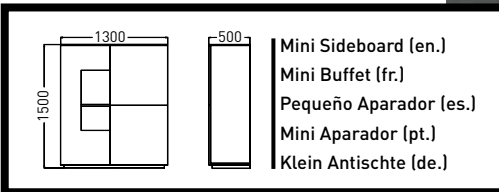

- Mini Sideboard (en.)
- Mini Buffet (fr.)
- Pequeño Aparador (es.)
- Mini Aparador (pt.)
- Klein Antische (de.)



dinning room

table and sideboard++

zoom out

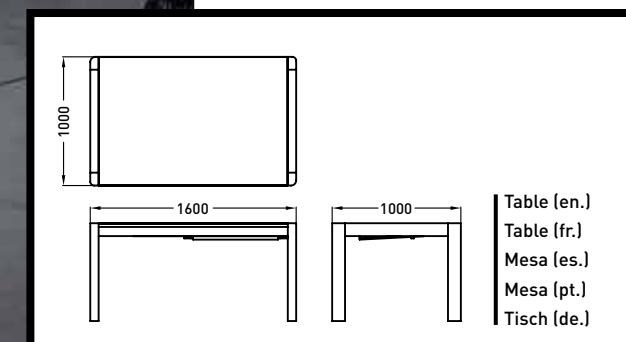
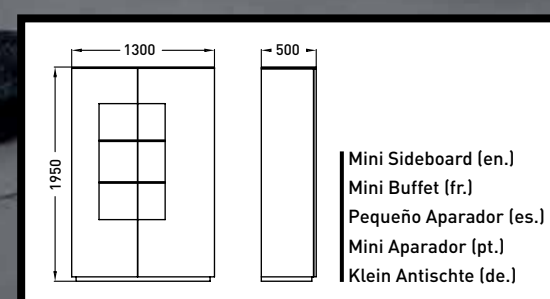



dinning room    table and sideboard++    zoom out

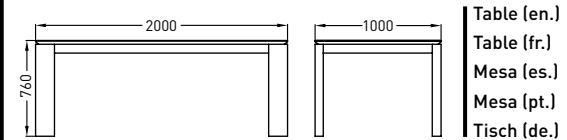
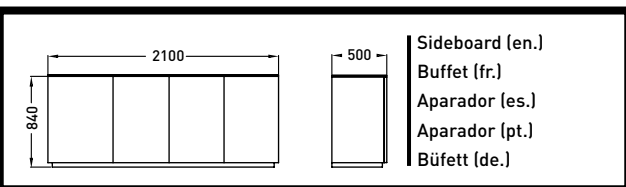

Table (en.)  
 Table (fr.)  
 Mesa (es.)  
 Mesa (pt.)  
 Tisch (de.)



dinning room table and sideboard++ zoom in







bar++  
zoom out + zoom in

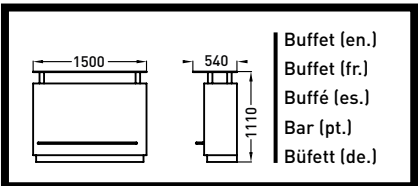

Buffet (en.)  
Buffet (fr.)  
Buffé (es.)  
Bar (pt.)  
Büfett (de.)



consoles++ zoom in + zoom out

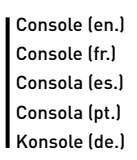
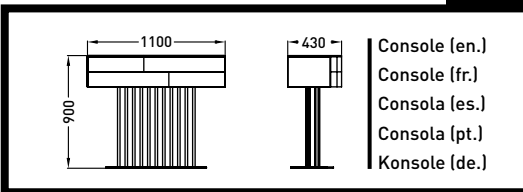

Console (en.)  
 Console (fr.)  
 Consola (es.)  
 Consola (pt.)  
 Konsole (de.)

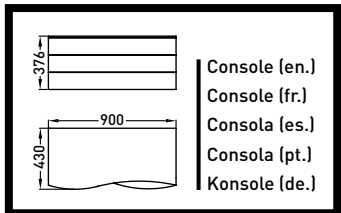

Console (en.)  
 Console (fr.)  
 Consola (es.)  
 Consola (pt.)  
 Konsole (de.)



consoles++    zoom in + zoom out





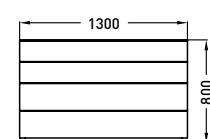

Häberdasher (en.)  
 Mercier (fr.)  
 Camisero (es.)  
 Camiseiro (pt.)  
 Kurzwarenhändler (de.)



bedroom++  
zoom out

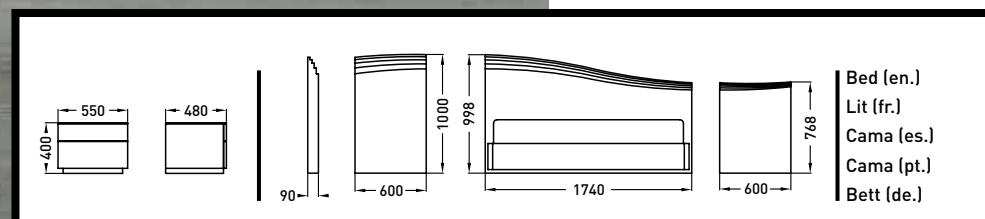

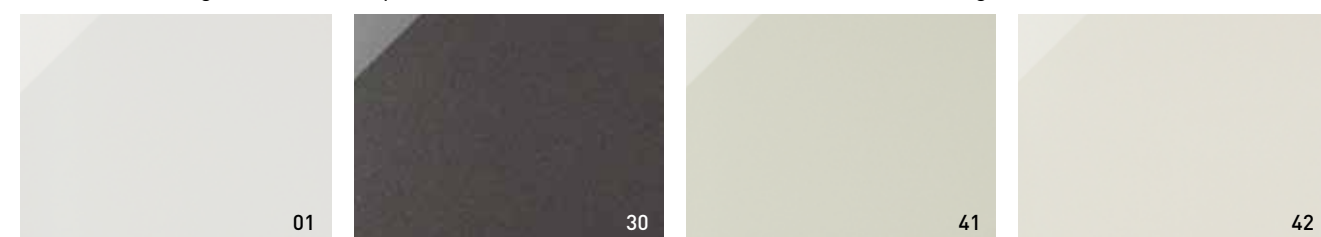
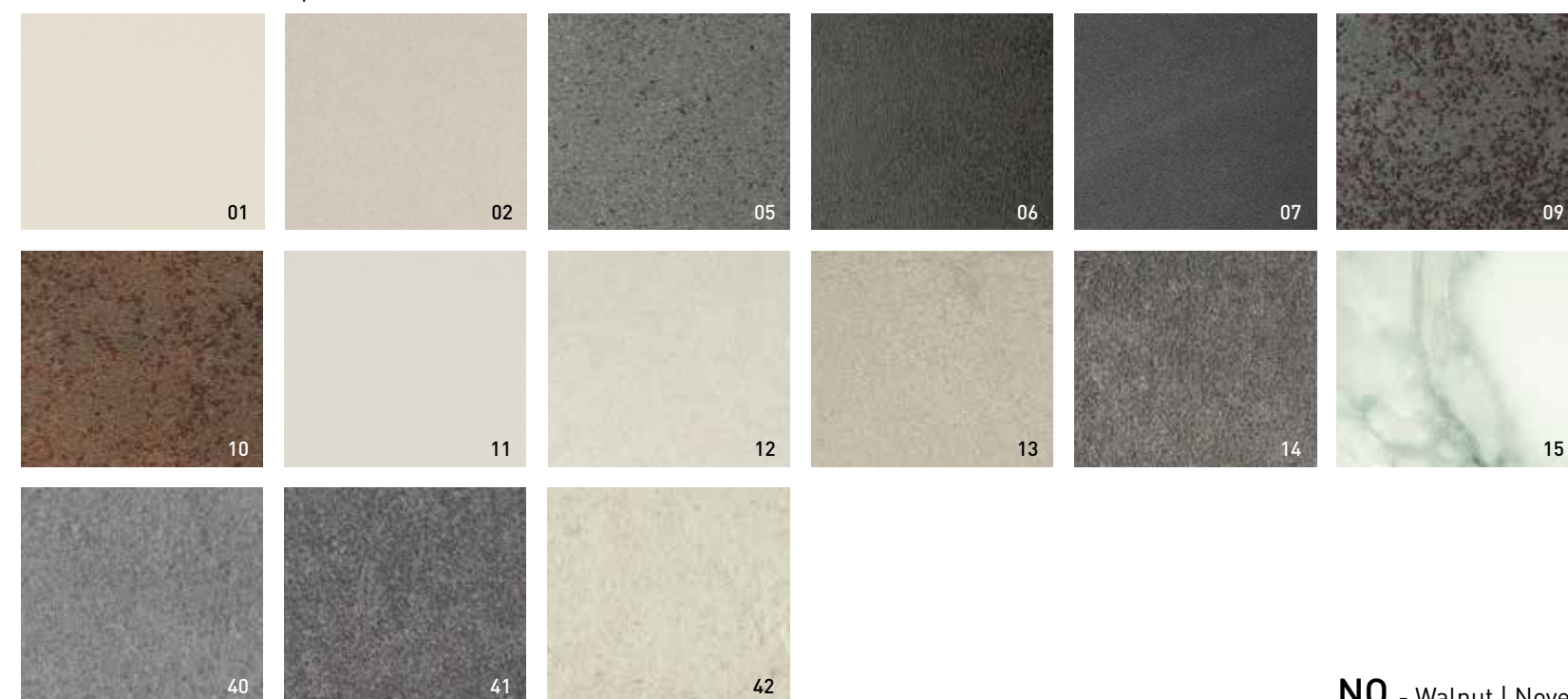
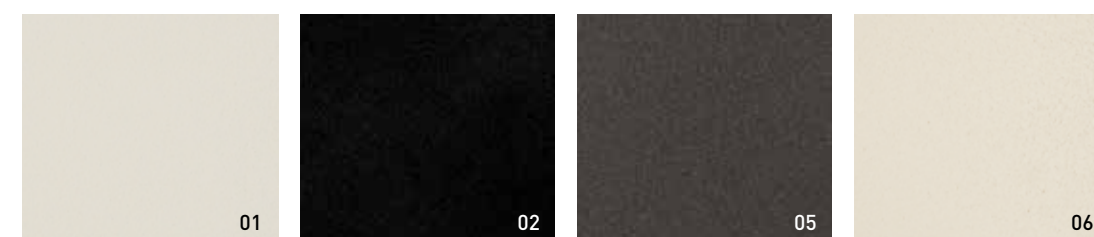
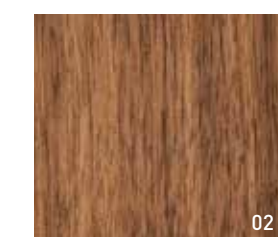

**LB / LM** - Lacquered | Laqués | Lacados | Lacados | Lackiert / **VR** - Glass | Vierre | Vidrio | Vidro | Glas**\*LB / LM Special** - Lacquered | Laqués | Lacados | Lacados | Lackiert**VM** - Frosted glass | Verre dépoli | Cristal esmerilado | Vidro fosco | Satiniertes glas**CA** - Oak | Chêne | Roble | Carvalho | Eiche**CR** - Ceramic | Céramique | Cerámica | Cerâmica | Keramik**FR** - Iron | Fer | Hierro | Ferro | Eisen**NO** - Walnut | Noyer  
Nogal | Nogueira  
Nussbaum



# NOW AND TOMORROW.

ENJOY!



WWW.LBFMOBILIARIO.COM

Lino Barros & Ferreira LDA

Rua dos Combatentes do Ultramar n.697

4620-201 Figueiras - Lousada - Portugal

+ 351 255 878 393 + 351 255 878 802

info@lbfmobiliario.com

---

**LBF®** reserves the right to make change to its products without prior notice. Droit de modifications de la part de **LBF®** sans pré-avis. I Queda reservado a **LBF®** el derecho de efectuar modificaciones a sus productos sin previo aviso. I Reserva a **LBF®** o direito de efectuar alterações aos seus productos sem aviso prévio. I **LBF®** beält sich das Recht vor, Änderungen an ihren Produkten ohne vorherige Mitteilung durchzuführen.





