



**GOYAA
NATURAA**

KATALOGUE · CATALOGUE · CATÁLOGO



Designed by Johnny dos Passos

INSPIRATION

L'INSPIRATION

INSPIRACIÓN | A INSPIRAÇÃO

DIE INSPIRATION

Comes and goes in a Perpetual movement.

When it flows through you, stay awake. | Vai

e vem num movimento Perpétuo. Quando ela

passar por ti, presta-lhe atenção. | Viene y se

va en el movimiento Perpetuo. Al pasar junto

a ti, verlo. | Va et vient dans un mouvement

Perpétuel. Quand elle te frôle, sois attentif. |

Kommt und geht in einer ewigen Bewegung.

Wenn Sie an dir vorbeizieht nehme Sie wahr.

Johnny Dos Passos
Designer



02 | GOYAA

14
GOYAA



24 | NATURAA



12
GOYAA



20 | NATURAA



08
GOYAA



26
NATURAA



28
NATURAA

NOW AND TOMORROW.

The history of our company was built on great challenges, with more than 50 years of experience in furniture manufacturing, our main concern is designing items that reflect original expressions of great aesthetic variety, freedom of composition and custom solutions. Using the most modern productive resources, investing in research and development of new products, a young and qualified team, we combine the most innovative materials, finishes and colours that make a distinct and innovative product. Our mission is to demonstrate the company's expertise and ability to supply products that satisfy the desires of our customers.

MAINTENANT ET DEMAIN.

C'est en relevant de grands défis que nous avons construit notre histoire avec une expérience de plus de 50 ans dans la fabrication de Meubles. Notre principale préoccupation est de concevoir des objets qui traduisent une expression originale, une grande variété esthétique, de la modulation et des solutions personnalisées. En utilisant des ressources de production moderne et en investissant dans la recherche et le développement de nouveaux produits, nous avons recours à une équipe de jeunes techniciens hautement qualifiés. Avec nos Designers nous combinons les matériaux innovants avec des finitions et des couleurs qui anticipent les tendances du marché pour proposer des produits distincts et intemporels. Notre mission principale est de mettre nos compétences au service de nos clients pour concrétiser aujourd'hui leurs projets de demain.

AHORA Y MAÑANA.

A partir de grandes desafíos se ha fraguado nuestra historia, con una experiencia de más de 50 años en la fabricación de mobiliario, su principal preocupación reside en concebir objetos que se traduzcan en expresiones originales de gran variedad estética, libertad de composición y soluciones personalizadas. Utilizando los más modernos recursos productivos, la inversión en investigación y desarrollo de nuevos productos, un equipo joven y cualificado, combinamos los materiales más innovadores, acabados y colores, que se traducen en un producto distinto e innovador. Nuestra misión es demostrar la competencia y capacidad de la empresa en el suministro de productos capaces de concretar los deseos de nuestros clientes.

AGORA E AMANHÃ.

É de grandes desafios que se faz a nossa história, com uma experiência de mais de 50 anos na fabricação de mobiliário, tem a preocupação dominante de conceber objetos que se traduzam em expressões originais de grande variedade estética, liberdade de composição e soluções personalizadas. Utilizando os mais modernos recursos produtivos, o investimento em investigação e desenvolvimento de novos produtos, uma equipa jovem e qualificada, combinamos os materiais mais inovadores, acabamentos e cores que se traduzem num produto distinto e inovador. A nossa missão é evidenciar a competência e capacidade da empresa no fornecimento de produtos capazes de concretizar os desejos dos nossos clientes.

JETZT UND MORGEN.

Es sind die großen Herausforderungen, die die Geschichte unser Unternehmen, die mehr als 50 Jahre Erfahrung in der Herstellung von Möbeln hat, ausmacht. Die Firma beschäftigt sich vorwiegend mit dem Entwurf von Objekten, die ursprüngliche Ausdrücke großer ästhetischer Vielfalt, freie Zusammenstellung und individuelle Lösungen aufweisen. Unter Einsatz der modernsten Produktionsmittel, Investition in Forschung und Entwicklung und eines jungen sowie qualifizierten Teams, kombinieren wir die innovativsten Materialien, Oberflächenbehandlungen und Farben, um ein herausragendes Produkt herzustellen. Unsere Mission besteht darin, die Kompetenz und Fähigkeit unser Unternehmen bei der Präsentation von Produkten, die in der Lage sind, die Wünsche unserer Kunden zu konkretisieren.



lbfmobiliário



GOYAA





dining room sideboard++ zoom in

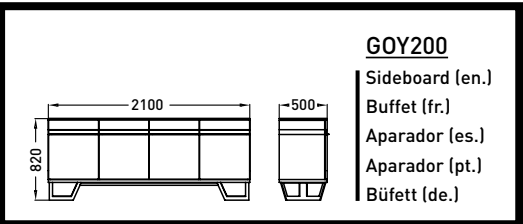

dinningroom

table and sideboard++

zoom in + zoom out



dinning room

table and sideboard++

zoom out

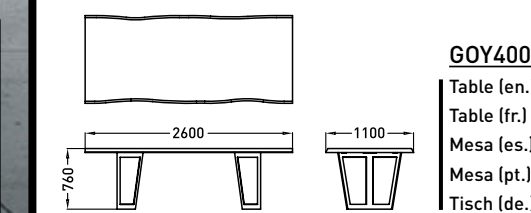
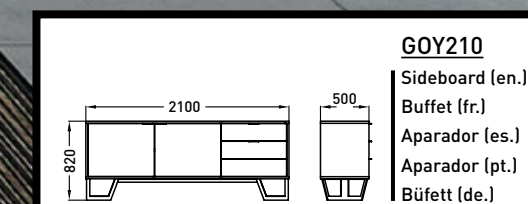

living room coffee table++ zoom in

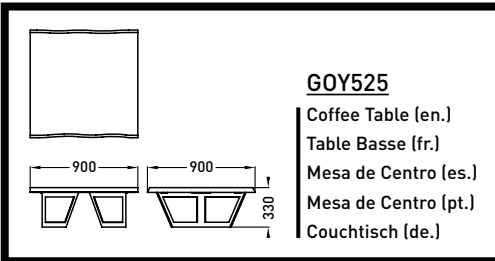

dinning room

table and sideboard++

zoom out

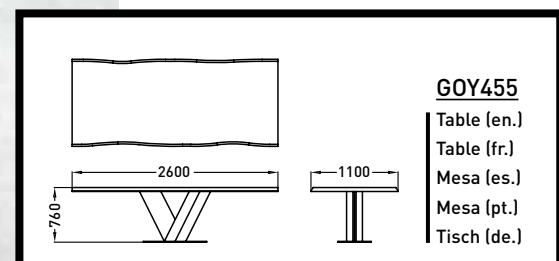

GOY455
 Table (en.)
 Table (fr.)
 Mesa (es.)
 Mesa (pt.)
 Tisch (de.)

dinning room

table and sideboard++ zoom out



dinning room table++ zoom in

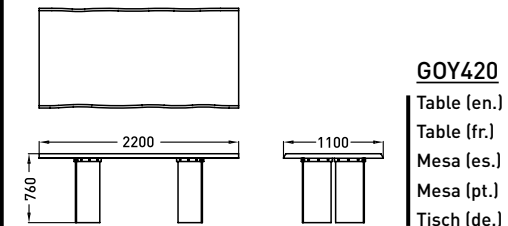
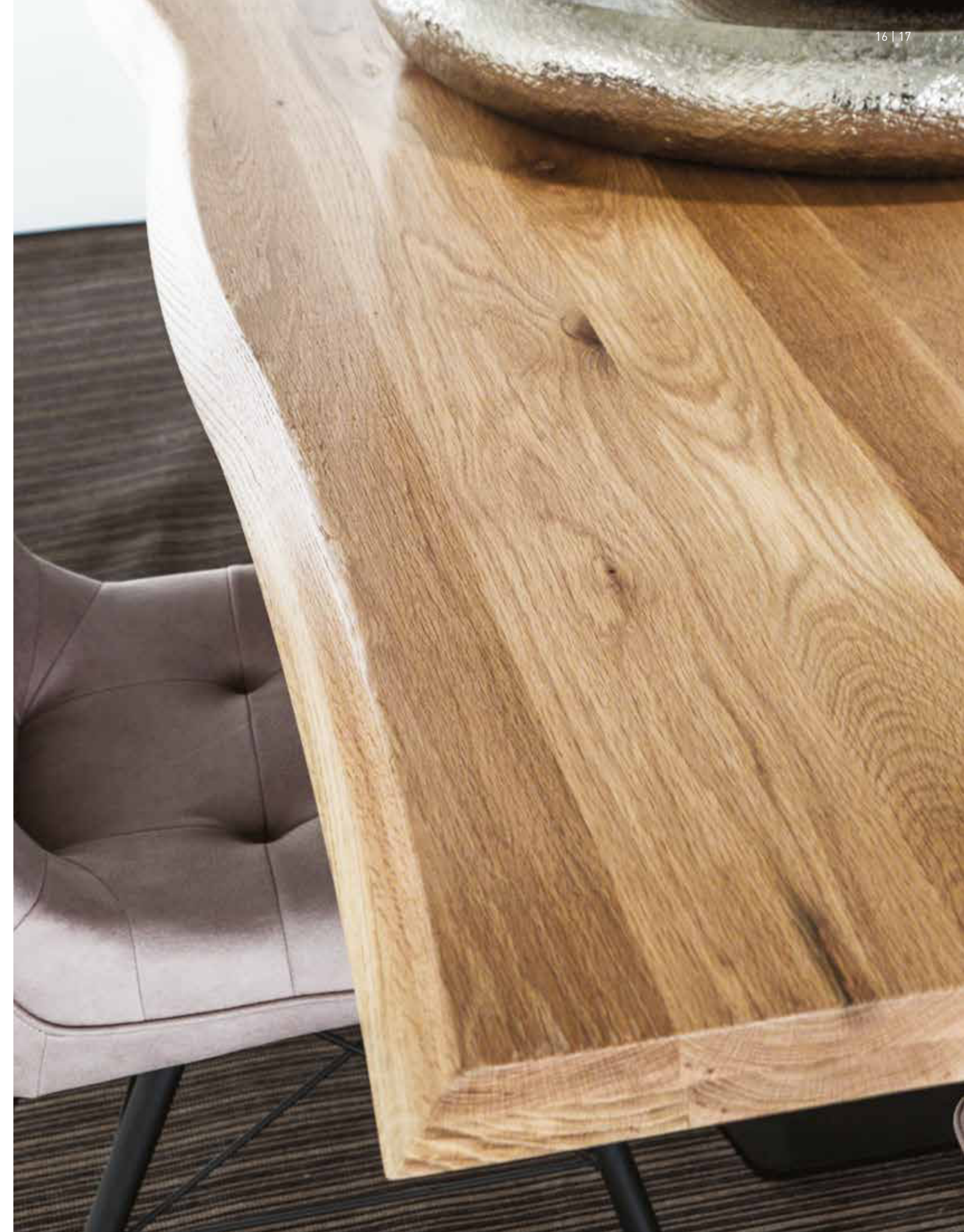

GOY420
Table (en.)
Table (fr.)
Mesa (es.)
Mesa (pt.)
Tisch (de.)



modular pieces++ zoom out



NATURA



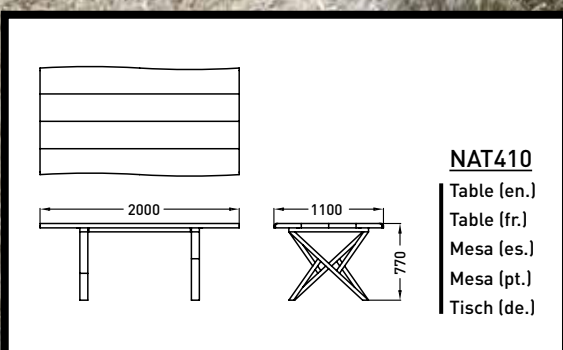

NAT410
 Table (en.)
 Table (fr.)
 Mesa (es.)
 Mesa (pt.)
 Tisch (de.)

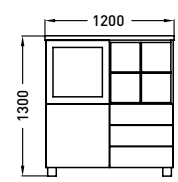

NAT960
 Highboard (en.)
 Buffet Haut (fr.)
 Aparador Alto (es.)
 Aparador Alto (pt.)
 Hochschrank (de.)

dinning room

table andsideboard++

zoom out

dinning room

table + sideboard++

zoom in + zoom out



dinning room sideboard++ zoom in

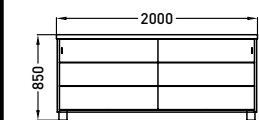

NAT221
Sideboard (en.)
Buffet (fr.)
Aparador (es.)
Aparador (pt.)
Büfett (de.)

dinning room table++ zoom in



bookcase++ zoom in + zoom out

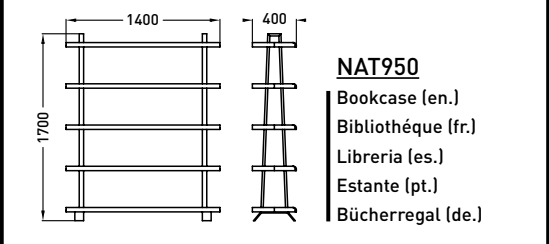

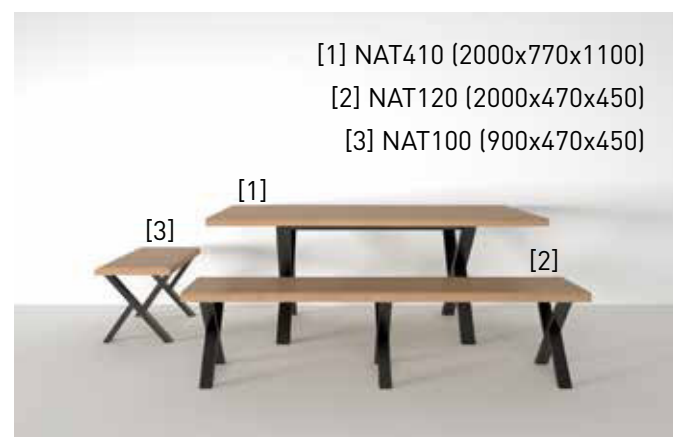

modular pieces++ zoom out

CR - Ceramic | Céramique | Cerámica | Cerâmica | Keramik

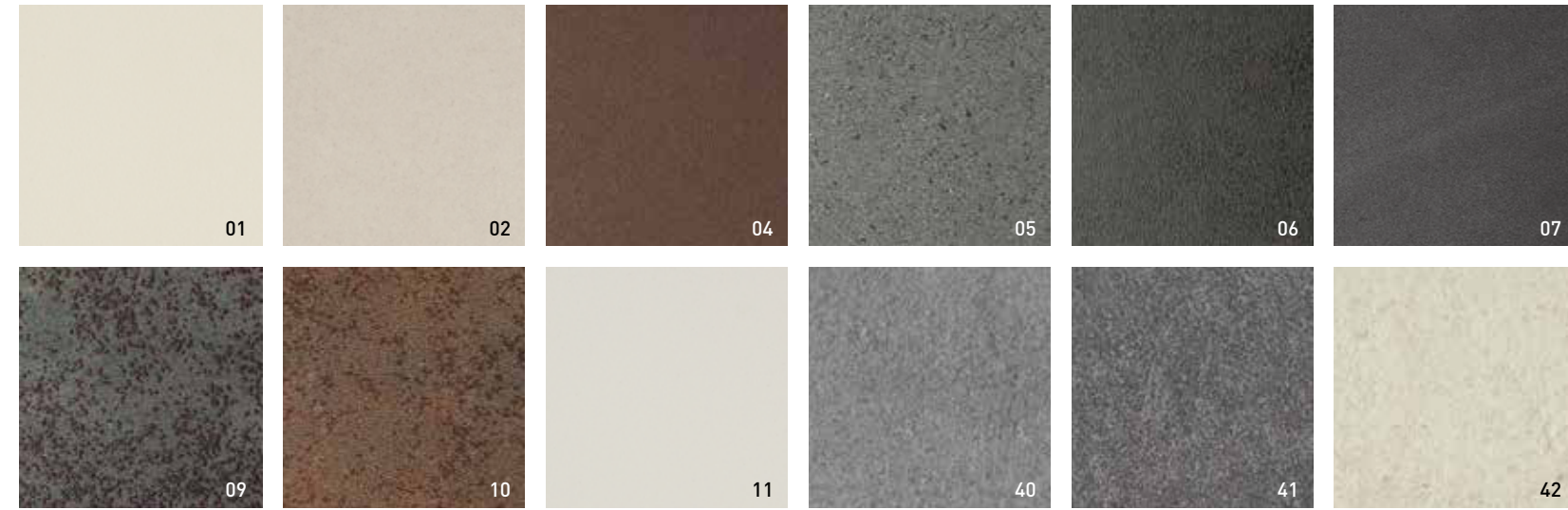

CM - Solid wood | Bois massif | Madera maciza | Madeira maciça | Massivholz

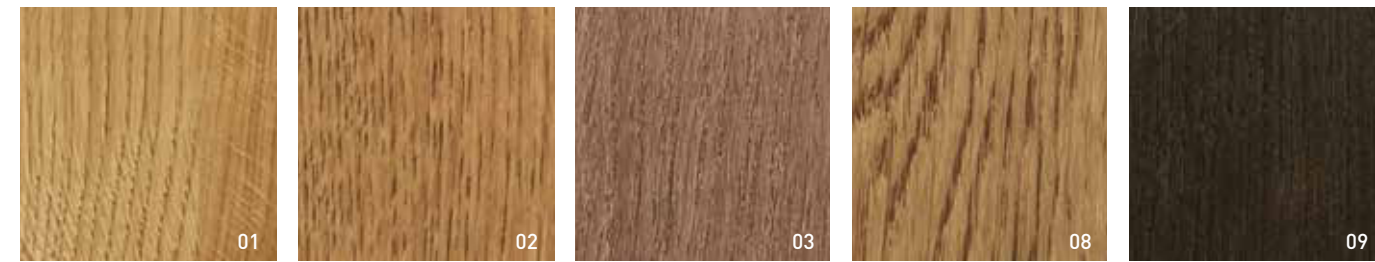

FR - Iron | Fer | Hierro | Ferro | Eisen



CA - Oak | Chêne | Roble | Carvalho | Eiche

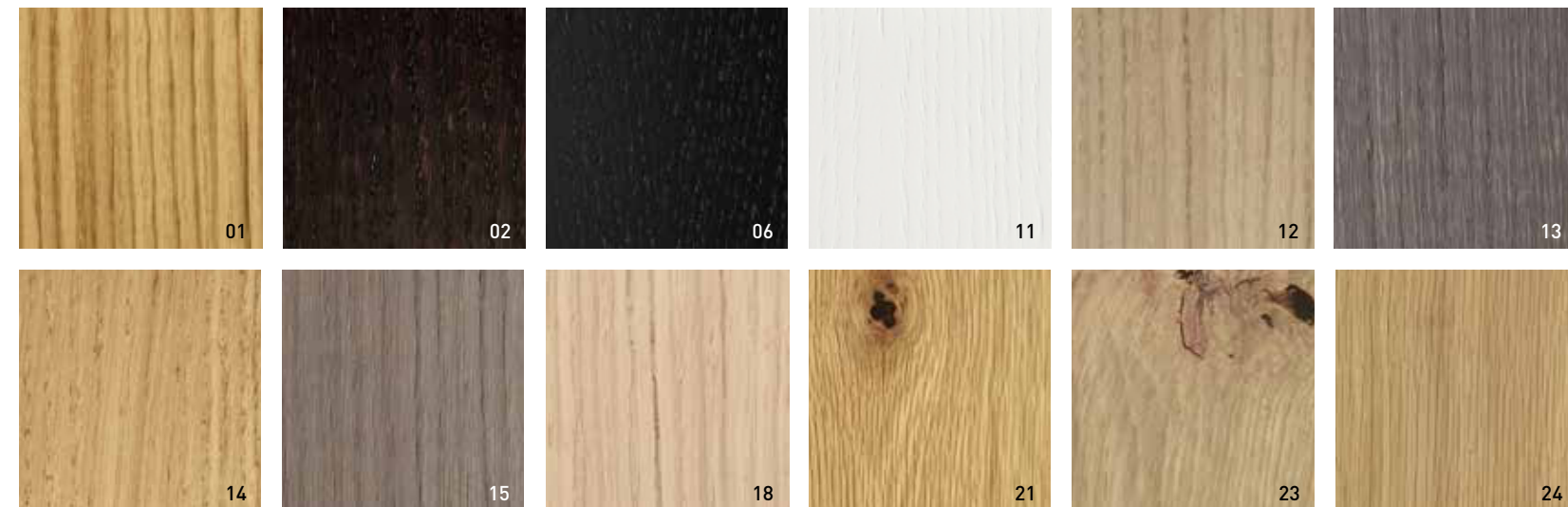

ENJOY!



WWW.LBFMOBILIARIO.COM

Lino Barros & Ferreira LDA

Rua dos Combatentes do Ultramar n.697

4620-201 Figueiras - Lousada - Portugal

+ 351 255 878 393 + 351 255 878 802

info@lbfmobilierio.com

LBF® reserves the right to make change to its products without prior notice. Droit de modifications de la part de **LBF®** sans pré-avis. I Queda reservado a **LBF®** el derecho de efectuar modificaciones a sus productos sin previo aviso. I Reserva a **LBF®** o direito de efectuar alterações aos seus productos sem aviso prévio. I **LBF®** beält sich das Recht vor, Änderungen an ihren Produkten ohne vorherige Mitteilung durchzuführen.

NOW AND TOMORROW.

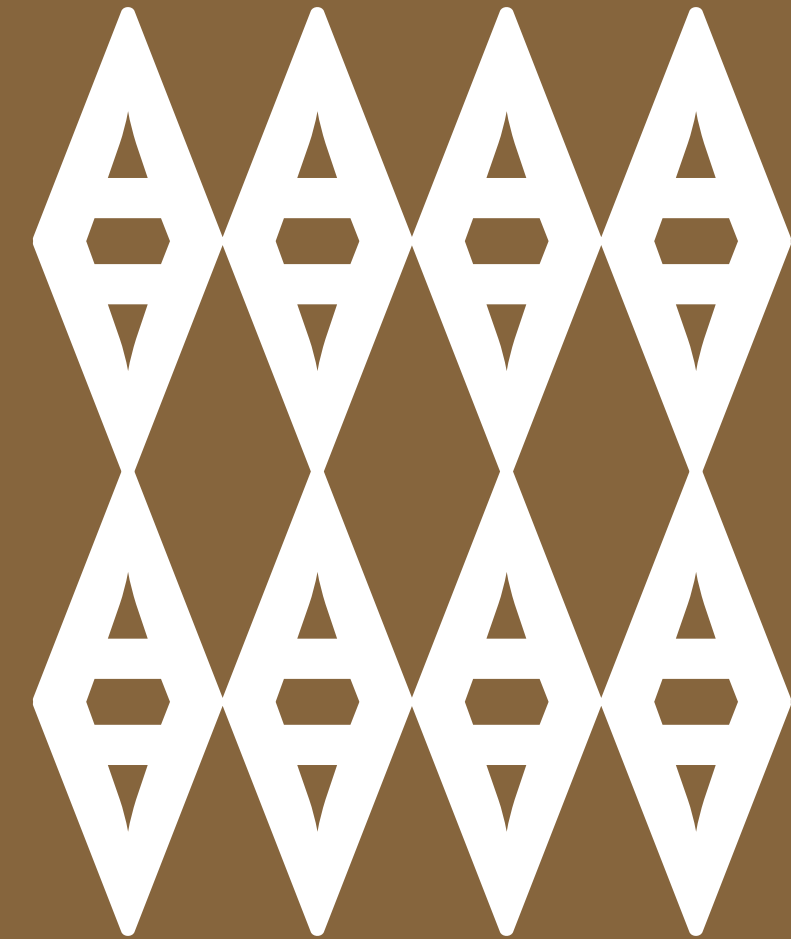



lbfmobiliário