

instrucciones de montaje/assembly instructions

x3

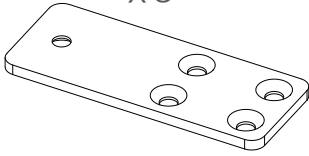

x3

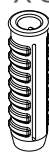

x9

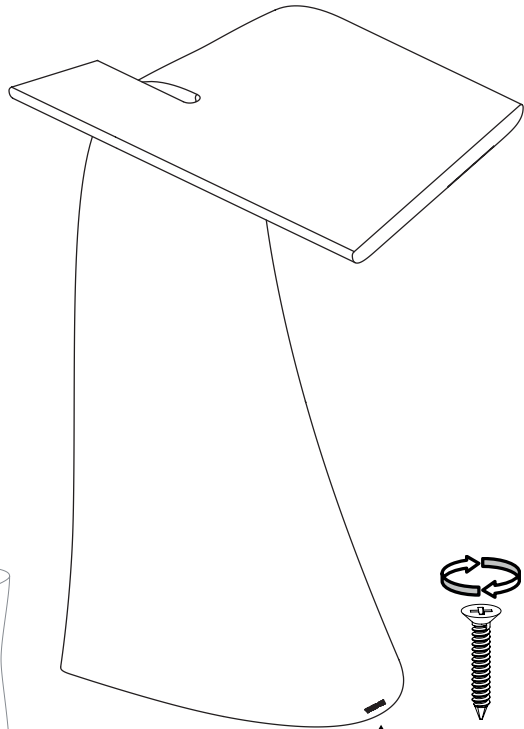

posición
position

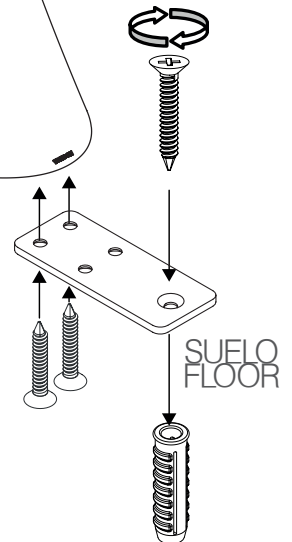
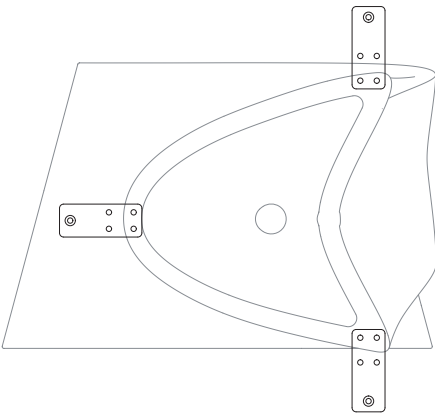

ANCLAJE AL SUELO

INTRODUCTION

Thank you very much for having purchased the product of VONDOM. It manufactured in resin of polyethylene by the technology of the rotational molding in the plant VONDOM, which is situated in Valencia.

Our production is managed according to the quality control system ISO 9001 and ISO 14001 and we only use the highest quality material to guarantee a long life usage to our products.

In VONDOM we know that you like to feel comfortable in every moment, therefore we have created different finished for our contemporary flowerpot collections, thought for different interior & exterior spaces:



FANG

Flowerpot made by resin of polyethylene, with simple wall. ONLY for outdoor.

Macetero en resina de polietileno, con pared simple.



FANG LACADAS

Flowerpot made by resin of polyethylene, with simple wall. Shinning lacquered finishing similar to the car paint. ONLY for outdoor.

Flowerpot made by resin of polyethylene, with simple wall. Shinning lacquered finishing similar to the car paint. ONLY for outdoor.



AIRE

Flowerpot made by resin of polyethylene, with double wall.

Macetero en resina de polietileno, con doble pared.



AIGUA

Flowerpot made by resin of polyethylene, with double wall. Included Selfwatering System.

Macetero en resina de polietileno, con doble pared. Contiene sistema de autoriego.



FOC

Flowerpot made by resin of polyethylene, with double wall. Shinning lacquered finishing similar to the car paint. Included Self Watering.

Macetero en resina de polietileno, con doble pared. Acabado lacado brillo con pintura para carrocerías. Contiene sistema de autoriego.

Our products are completely suitable for both indoor & outdoor use, and 8,000 hours intense exposure under the sunlight of Florida is guaranteed.

INTRODUCCION

Le agradecemos el haber adquirido producto VONDOM. Fabricado con resina de Polietileno mediante la tecnología del moldeo rotacional en la planta VONDOM, situada en Valencia.

Nuestra producción se rige según las normas de nuestro sistema de aseguramiento de la calidad ISO 9001 y del medio ambiente ISO 14001, sólo utilizamos materiales de altísima calidad para garantizar una larga vida útil a los productos.

En VONDOM sabemos que te gusta sentirte cómodo en todo momento, por eso hemos creado diferentes acabados para nuestras colecciones de maceteros contemporáneos, pensados para diversos espacios tanto de interior como exterior:



LLUM

Flowerpot made by resin of polyethylene, with double wall. White lighting inside by means of energy saving lamps. Included selfwatering system.

Macetero en resina de polietileno, con doble pared. Iluminación blanca en el interior con lámparas de bajo consumo. Contiene sistema de autoriego.



LED RGB

Flowerpot made by resin of polyethylene, with double wall. Lighting inside by means of led technology, included a remote control. Included Selfwatering System.

Macetero en resina de polietileno, con doble pared. Iluminación en el interior mediante Tecnología Led. Contiene sistema de autoriego.



NANO

Reproduction of our flower pots of double walls in miniature.

Reproducción de nuestros maceteros de doble pared en miniatura.



NANO LACADAS

Mini flowerpot made by resin of polyethylene, with double wall. Shinning lacquered finishing similar to the car paint.

Reproducción de nuestros maceteros de doble pared en miniatura. Acabado lacado brillo con pintura para carrocerías.



NANO LLUM

Flower pots in miniature of double walls with LED.

Maceteros en miniatura de doble pared con iluminación LED.

Nuestros productos son completamente aptos para uso interior como de exterior, y están garantizados por 8.000 horas de intensa exposición al sol de Florida.