







GLOBO 30 HANGING design SLIDE Studio



Lampada a sospensione
 Anno di produzione: 1999
 Versioni: luminosa.
 Materiali: Polietilene.
 Dimensioni: Ø 30 cm
 Peso: 1,2 Kg
 Imballaggio: 31 x 31 x 31 cm
 Volume imballaggio: 0,03 m³

Suspension
 Année de production: 1999
 Versions: lumineuse.
 Matériaux: Polyéthylène.
 Dimensions: Ø 30 cm
 Poids: 1,2 Kg
 Emballage: 31 x 31 x 31 cm
 Volume emballage: 0,03 m³

Hanging lamp
 Year of production: 1999
 Versions: lighting.
 Material: Polyethylene.
 Dimensions: Ø 30 cm
 Weight: 1,2 Kg
 Packaging: 31 x 31 x 31 cm
 Packaging volume: 0,03 m³

DIMENSIONS (cm)	
CODE	<p> LP SF1030 lighting IN GLOSSY FINISH  </p> <p> LP SF1032 lighting IN MATT FINISH  </p> <p> LP SFH030 lighting OUT GLOSSY FINISH  </p>
LIGHTING	<div style="border: 1px solid black; border-radius: 10px; padding: 5px; display: inline-block;"> 1x  15W </div> <p>Energy saving bulb recommended (not included).</p>
COLOURS	<p>LIGHTING</p> <p><input type="radio"/> LIGHT WHITE (code LA)</p>

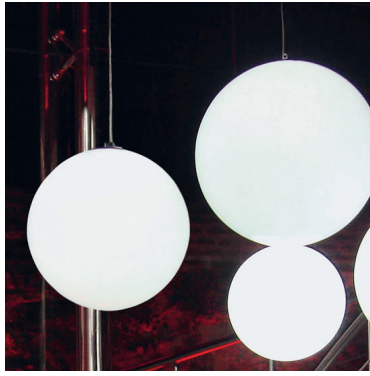

GLOBO 40 HANGING design SLIDE Studio



Lampada a sospensione
 Anno di produzione: 2001
 Versioni: luminosa.
 Materiali: Polietilene.
 Dimensioni: Ø 40 cm
 Peso: 2 Kg
 Imballaggio: 41 x 41 x 41 cm
 Volume imballaggio: 0,069 m³

Suspension
 Année de production: 2001
 Versions: lumineuse.
 Matériaux: Polyéthylène.
 Dimensions: Ø 40 cm
 Poids: 2 Kg
 Emballage: 41 x 41 x 41 cm
 Volume emballage: 0,069 m³

Hanging lamp
 Year of production: 2001
 Versions: lighting.
 Material: Polyethylene.
 Dimensions: Ø 40 cm
 Weight: 2 Kg
 Packaging: 41 x 41 x 41 cm
 Packaging volume: 0,069 m³

DIMENSIONS (cm)					
CODE	<table style="width: 100%; border: none;"> <tr> <td style="width: 50%; vertical-align: top;"> <p>LP SF1040 lighting IN GLOSSY FINISH</p> </td> <td style="width: 50%; vertical-align: top;"> <p>LP SF1042 lighting IN MATT FINISH</p> </td> </tr> <tr> <td style="vertical-align: top;"> <p>LP SFH040 lighting OUT GLOSSY FINISH</p> </td> <td></td> </tr> </table>	<p>LP SF1040 lighting IN GLOSSY FINISH</p>	<p>LP SF1042 lighting IN MATT FINISH</p>	<p>LP SFH040 lighting OUT GLOSSY FINISH</p>	
<p>LP SF1040 lighting IN GLOSSY FINISH</p>	<p>LP SF1042 lighting IN MATT FINISH</p>				
<p>LP SFH040 lighting OUT GLOSSY FINISH</p>					
LIGHTING	<p>Energy saving bulb recommended (not included).</p>				
COLOURS	<p>LIGHTING</p> <p>○ LIGHT WHITE (code LA)</p>				

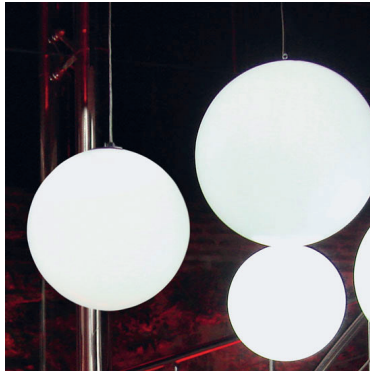

GLOBO 50 HANGING design SLIDE Studio



Lampada a sospensione
 Anno di produzione: 2001
 Versioni: luminosa.
 Materiali: Polietilene.
 Dimensioni: Ø 50 cm
 Peso: 3,5 Kg
 Imballaggio: 51 x 51 x 51 cm
 Volume imballaggio: 0,133 m³

Suspension
 Année de production: 2001
 Versions: lumineuse.
 Matériaux: Polyéthylène.
 Dimensions: Ø 50 cm
 Poids: 3,5 Kg
 Emballage: 51 x 51 x 51 cm
 Volume emballage: 0,133 m³

Hanging lamp
 Year of production: 2001
 Versions: lighting.
 Material: Polyethylene.
 Dimensions: Ø 50 cm
 Weight: 3,5 Kg
 Packaging: 51 x 51 x 51 cm
 Packaging volume: 0,133 m³

DIMENSIONS (cm)	
CODE	<p>LP SFI050 lighting IN GLOSSY FINISH</p> <p>LP SFH050 lighting OUT GLOSSY FINISH</p> <p>LP SFI052 lighting IN MATT FINISH</p>
LIGHTING	<p>1x 25W</p> <p>Energy saving bulb recommended (not included).</p>
COLOURS	<p>LIGHTING</p> <p>○ LIGHT WHITE (code LA)</p>

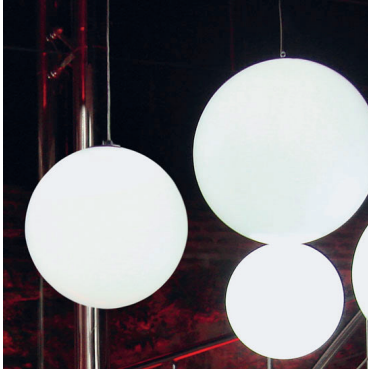

GLOBO 60 HANGING design SLIDE Studio



Lampada a sospensione
 Anno di produzione: 2000
 Versioni: luminosa.
 Materiali: Polietilene.
 Dimensioni: Ø 60 cm
 Peso: 4,7 Kg
 Imballaggio: 61 x 61 x 61 cm
 Volume imballaggio: 0,227 m³

Suspension
 Année de production: 2000
 Versions: lumineuse.
 Matériaux: Polyéthylène.
 Dimensions: Ø 60 cm
 Poids: 4,7 Kg
 Emballage: 61 x 61 x 61 cm
 Volume emballage: 0,227 m³

Hanging lamp
 Year of production: 2000
 Versions: lighting.
 Material: Polyethylene.
 Dimensions: Ø 60 cm
 Weight: 4,7 Kg
 Packaging: 61 x 61 x 61 cm
 Packaging volume: 0,227 m³

DIMENSIONS (cm)					
CODE	<table style="width: 100%; border: none;"> <tr> <td style="width: 50%; vertical-align: top;"> <p>LP SFI060 lighting IN GLOSSY FINISH</p> </td> <td style="width: 50%; vertical-align: top;"> <p>LP SFH062 lighting OUT MATT FINISH</p> </td> </tr> <tr> <td style="vertical-align: top;"> <p>LP SFH060 lighting OUT GLOSSY FINISH</p> </td> <td></td> </tr> </table>	<p>LP SFI060 lighting IN GLOSSY FINISH</p>	<p>LP SFH062 lighting OUT MATT FINISH</p>	<p>LP SFH060 lighting OUT GLOSSY FINISH</p>	
<p>LP SFI060 lighting IN GLOSSY FINISH</p>	<p>LP SFH062 lighting OUT MATT FINISH</p>				
<p>LP SFH060 lighting OUT GLOSSY FINISH</p>					
LIGHTING	<p>Energy saving bulb recommended (not included).</p>				
COLOURS	<p>LIGHTING</p> <p>○ LIGHT WHITE (code LA)</p>				



GLOBO 70 HANGING design SLIDE Studio



Lampada a sospensione
 Anno di produzione: 2001
 Versioni: luminosa.
 Materiali: Polietilene.
 Dimensioni: Ø 70 cm
 Peso: 7,2 Kg
 Imballaggio: 71 x 71 x 71 cm
 Volume imballaggio: 0,358 m³

Suspension
 Année de production: 2001
 Versions: lumineuse.
 Matériaux: Polyéthylène.
 Dimensions: Ø 70 cm
 Poids: 7,2 Kg
 Emballage: 71 x 71 x 71 cm
 Volume emballage: 0,358 m³

Hanging lamp
 Year of production: 2001
 Versions: lighting.
 Material: Polyethylene.
 Dimensions: Ø 70 cm
 Weight: 7,2 Kg
 Packaging: 71 x 71 x 71 cm
 Packaging volume: 0,358 m³

DIMENSIONS (cm)					
CODE	<table style="width: 100%; border: none;"> <tr> <td style="width: 50%; border: none;"> <p>LP SFI070 lighting IN GLOSSY FINISH</p> </td> <td style="width: 50%; border: none;"> <p>LP SFI072 lighting IN MATT FINISH</p> </td> </tr> <tr> <td style="border: none;"> <p>LP SFH070 lighting OUT GLOSSY FINISH</p> </td> <td style="border: none;"></td> </tr> </table>	<p>LP SFI070 lighting IN GLOSSY FINISH</p>	<p>LP SFI072 lighting IN MATT FINISH</p>	<p>LP SFH070 lighting OUT GLOSSY FINISH</p>	
<p>LP SFI070 lighting IN GLOSSY FINISH</p>	<p>LP SFI072 lighting IN MATT FINISH</p>				
<p>LP SFH070 lighting OUT GLOSSY FINISH</p>					
LIGHTING	<div style="display: flex; align-items: center;"> <div style="border: 1px solid black; border-radius: 10px; padding: 5px; margin-right: 10px;"> <p style="text-align: center; margin: 0;">1x</p> <p style="text-align: center; margin: 0;">65W</p> </div> <p>Energy saving bulb recommended (not included).</p> </div>				
COLOURS	<p>LIGHTING</p> <p>○ LIGHT WHITE (code LA)</p>				



GLOBO 80 HANGING design SLIDE Studio



Lampada a sospensione
 Anno di produzione: 2007
 Versioni: luminosa.
 Materiali: Polietilene.
 Dimensioni: Ø 80 cm
 Peso: 8 Kg
 Imballaggio: 81 x 81 x 81 cm
 Volume imballaggio: 0,531 m³

Suspension
 Année de production: 2007
 Versions: lumineuse.
 Matériaux: Polyéthylène.
 Dimensions: Ø 80 cm
 Poids: 8 Kg
 Emballage: 81 x 81 x 81 cm
 Volume emballage: 0,531 m³

Hanging lamp
 Year of production: 2007
 Versions: lighting.
 Material: Polyethylene.
 Dimensions: Ø 80 cm
 Weight: 8 Kg
 Packaging: 81 x 81 x 81 cm
 Packaging volume: 0,531 m³

DIMENSIONS (cm)	
CODE	<p>LP SF1080 lighting IN GLOSSY FINISH</p> <p>LP SFH080 lighting OUT GLOSSY FINISH</p>
LIGHTING	<p>1x 65W</p> <p>Energy saving bulb recommended (not included).</p>
COLOURS	<p>LIGHTING</p> <p>○ LIGHT WHITE (code LA)</p>



GLOBO 120 HANGING design SLIDE Studio



Lampada a sospensione
 Anno di produzione: 2003
 Versioni: luminosa.
 Materiali: Polietilene.
 Dimensioni: Ø 120 cm
 Peso: 25 Kg
 Imballaggio: 121 x 121 x 121 cm
 Volume imballaggio: 1,772 m³

Suspension
 Année de production: 2003
 Versions: lumineuse.
 Matériaux: Polyéthylène.
 Dimensions: Ø 120 cm
 Poids: 25 Kg
 Emballage: 121 x 121 x 121 cm
 Volume emballage: 1,772 m³

Hanging lamp
 Year of production: 2003
 Versions: lighting.
 Material: Polyethylene.
 Dimensions: Ø 120 cm
 Weight: 25 Kg
 Packaging: 121 x 121 x 121 cm
 Packaging volume: 1,772 m³

DIMENSIONS (cm)	
CODE	<p>LP SFI120 lighting IN</p> <p>MATT FINISH</p>
LIGHTING	<p>1x</p> <p>105W</p> <p>Energy saving bulb recommended (not included).</p>
COLOURS	<p>LIGHTING</p> <p>○ LIGHT WHITE (code LA)</p>

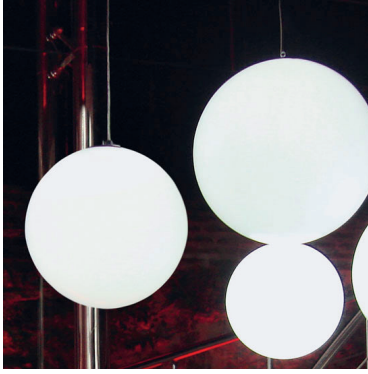

GLOBO 200 HANGING design SLIDE Studio











Lampada a sospensione
 Anno di produzione: 2004
 Versioni: luminosa.
 Materiali: Polietilene.
 Dimensioni: Ø 200 cm
 Peso: 93 Kg
 Imballaggio: 202 x 202 x 249 cm
 Volume imballaggio: 10,16 m³

Suspension
 Année de production: 2004
 Versions: lumineuse.
 Matériaux: Polyéthylène.
 Dimensions: Ø 200 cm
 Poids: 93 Kg
 Emballage: 202 x 202 x 249 cm
 Volume emballage: 10,16 m³























Hanging lamp
 Year of production: 2004
 Versions: lighting.
 Material: Polyethylene.
 Dimensions: Ø 200 cm
 Weight: 93 Kg
 Packaging: 202 x 202 x 249 cm
 Packaging volume: 10,16 m³

DIMENSIONS (cm)			
CODE	LP SFI200 lighting IN		MATT FINISH
LIGHTING		Energy saving bulb recommended (not included).	
COLOURS	LIGHTING <input type="radio"/> LIGHT WHITE (code LA)		



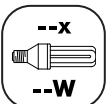

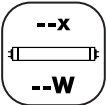
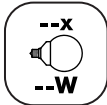

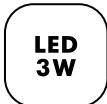

SYMBOLS

 For indoor use.	 Stackable item.	 Conformity to the European Community instructions.
 For indoor and outdoor use.	 100% recyclable polyethylene.	 Recycling and disposal of electronic waste (WEEE).
 Outdoor version on request (IP55).	 European Community registered model.	

LIGHTING SYMBOLS

 Protected against the intrusion of solid objects $\varnothing > 12$ mm, not against water.	 Standard lamp base for E27 - 27 mm light bulb.	 RGB lighting system.
 Protected against the intrusion of solid objects $\varnothing > 1$ mm and splashing water.	 Lamp base for G4 halogen bulb.	 Item compatible with Candy Light.
 Protected against the intrusion of dust and water jets.	 Lamp base for GU10 spotlight.	 Insulation class 1.
 Fully protected against the intrusion of dust and immersion in water.	 Lamp base for G13 neon tube.	 Insulation class 2.
 Small lamp base for E14 - 14 mm light bulb.	 Neon tube lighting system.	 Insulation class 3.
 Medium lamp base for E26 - 26 mm light bulb.	 LED technology lighting system.	 Device proper to direct assembly onto normally inflammable surfaces.
 Lighting through energy saving bulb. The upper figure shows the number of allowed bulbs. The lower figure shows the MAXIMUM recommended power.	 Lighting through energy saving fluorescent spotlight. The upper figure shows the number of allowed spotlights. The lower figure shows the MAXIMUM recommended power.	
 Lighting through neon tube. The upper figure shows the number of allowed neon tubes. The lower figure shows the MAXIMUM recommended power.	 Lighting through energy saving globe bulb. The upper figure shows the number of allowed bulbs. The lower figure shows the MAXIMUM recommended power.	
 Lighting through flexible LED tube. The lower figure shows the MAXIMUM recommended power.	 Lighting through circular T9 neon tube. The upper figure shows the number of allowed neon tubes. The lower figure shows the MAXIMUM recommended power.	

WIRING SYMBOLS

 Wiring with metal clamp. IP20 protection. Diameter 11 cm.	 Wiring with special base for KIT LED 3 WATT. IP55 protection. Diameter 11,6 cm.
 Wiring with metal base. IP55 protection. Diameter 10 cm. Fastening by hex screw key.	 Wiring with plastic screw base. I3 - IP20 protection. E3 - IP55 protection. Diameter 6 cm.
 Wiring with metal base. IP55 protection. Diameter 20 cm. Fastening by hex screw key.	 Wiring with plastic screw base. I3 - IP20 protection. E3 - IP55 protection. Diameter 10 cm.
 Wiring with plastic base and metal inserts. I2 - IP20 protection. E2 - IP55 protection. Diameter 10 cm. Fastening by slot screwdriver.	 Wiring with plastic screw base. I3 - IP20 protection. E3 - IP55 protection. Diameter 15 cm.
 Wiring with plastic base and LED CANDY LIGHT. IP44 protection. Diameter 10 cm.	 Special metal base. IP20 protection. Several sizes.

MATERIAL PROPERTIES

Material: Linear low-density polyethylene - LLDPE.

Production process: rotational moulding.

Resistant to extreme temperatures (-60°C to +80°C).

UV resistant (except for lighting colours).

High tensile strength.

WARNING

- Keep away from excessive heat sources.
- Avoid any improper use. Do not stand on the products. When the product has to be moved, lift the product off the ground in order to avoid damage.
- Do not overload the pot structure in order to avoid deforming.
- Carefully comply with the maintenance & cleaning instructions.
- In case of malfunctioning or damage of the wiring or any electrical parts, refer to a qualified electrician.

MAINTENANCE & CLEANING

- To prevent dust and dirt from sticking to the plastic surfaces, periodically clean the products with a damp cloth and neutral liquid soap diluted in water.
- Avoid using ethanol or any liquids containing, even in small amounts, acetone, trichloroethylene or ammonia (solvents in general).
- It is recommended the use of SLIDE's "CleanUp" cleaner or a degreaser. Spray the cleaning product on the surface, rub with a damp cloth and rinse abundantly with water (preferably with a high pressure washer). In case of persistent stains use a high pressure washer or scrub eraser. The use of the scrub eraser (melamine foam - Scotch-Brite® Easy Eraser or similar) is only recommended for white colour, as they are slightly abrasive.
- The lacquered version is also suitable for outdoor use, however it is more sensitive to scratches: periodically clean with a polish cleaner, gently rubbing with soft cloth/cotton wool.
- Cushions can be cleaned with a damp cloth, neutral liquid soap and water.
- For metal parts use specific cleaners.

SUSTAINABILITY & RECYCLING

All SLIDE products are 100% recyclable. Furthermore, grey, black and chocolate matt colours are produced with recycled polyethylene. SLIDE has a closed production cycle with no health prejudicial emissions and complying with ecological sustainability rules.

When a product reaches the end of its life, do not treat the product or any of its parts as domestic waste. Dispose by sending to differentiated collection centres.

RESPONSIBILITY & RETURNS

SLIDE declines any liability to damages caused to things or persons by an illegitimate use of the product. SLIDE won't accept any returned goods without having checked the kind of defects first.

WARRANTY

SLIDE products are guaranteed against all manufacturing faults, granted that the items are appropriately used, for twenty-four (24) months from the date of purchase upon presentation of the invoice.

LED KITS only are guaranteed for twelve (12) months from the date of purchase.

Warranty doesn't include parts that are subject to wear and tear due to usage, batteries when provided, wiring and electrical parts that do not have manufacturing faults.

